

THE RUDOLF REPORT

**EXPERT REPORT ON CHEMICAL & TECHNICAL ASPECTS
OF THE 'GAS CHAMBERS' OF AUSCHWITZ**

New second expanded and revised edition by Gernar Rudolf and Dr. Wolfgang Lambrecht. In 1988, Fred Leuchter, American expert for execution technologies, investigated the alleged gas chambers of Auschwitz and Majdanek and concluded that they could not have functioned as claimed. Ever since, Leuchter's claims have been attacked. In 1993, Rudolf, a researcher from the prestigious Max Planck Institute, published a thorough forensic study about the "gas chambers" of Auschwitz. His report irons out the deficiencies and discrepancies of "The Leuchter Report." The Rudolf Report was the first English edition of this sensational scientific work. This new edition analyzes all existing evidence on the Auschwitz gas chambers and offers even more evidence. The conclusions are startling. Appendix describes Rudolf's unique persecution—this brilliant scientist was so feared by the mainstream holocaust establishment that they banned him from writing about or researching the subject as terms of his release from prison!

Here's what just one scholar had to say about this book: "I am extraordinarily impressed. To my knowledge, you are the first expert in Germany who has addressed this particular topic in a scholarly impeccable and well-founded way. It is not for me to attribute an ice-breaker function to your expert report. It is easy to see which political-historical effects will originate from it, though its entire dimension cannot yet be estimated." —Prof. Dr. Hellmut Diwald, 1992

THE RUDOLF REPORT (softcover, 457 pages, indexed, illustrated, #378, \$33 minus 10% for TBR subscribers) can be ordered from TBR BOOK CLUB, P.O. Box 15877, Washington, D.C. 20003. Inside U.S. add \$5 S&H. Outside U.S. email TBRca@aol.com for best S&H to your nation. To charge a copy to Visa, MasterCard, AmEx or Discover, call TBR toll free at 1-877-773-9077. Bulk prices available: Email TBRca@aol.com. See more at www.barnesreview.com.

THE RUDOLF REPORT

RUDOLF & LAMBRECHT

THE RUDOLF REPORT

**EXPERT REPORT ON CHEMICAL & TECHNICAL ASPECTS
OF THE 'GAS CHAMBERS' OF AUSCHWITZ**



TBR

GERMAR RUDOLF • DR. WOLFGANG LAMBRECHT

PUBLISHED BY THE BARNES REVIEW

ISBN 978-0-9646312-7-8



9 780984 631278

Manufactured in the U.S.A.

THE BARNES REVIEW

P.O. Box 15877

Washington, D.C. 20003

www.BarnesReview.org

1-877-773-9077 toll free

THE RUDOLF REPORT

**EXPERT REPORT ON CHEMICAL
AND TECHNICAL ASPECTS OF THE
'GAS CHAMBERS' OF AUSCHWITZ**

2ND REVISED AND EXPANDED EDITION

EDITED BY DR. WOLFGANG LAMBRECHT

**Dedicated to the unknown
thousands of Germans now
suffering political persecution
in their own country.**

BY GERMAR RUDOLF

THE RUDOLF REPORT

**EXPERT REPORT ON CHEMICAL
AND TECHNICAL ASPECTS OF THE
'GAS CHAMBERS' OF AUSCHWITZ**

2ND REVISED AND EXPANDED EDITION
EDITED BY DR. WOLFGANG LAMBRECHT

PUBLISHED BY THE BARNES REVIEW
P.O. BOX 15877
WASHINGTON, D.C. 20003

HOLOCAUST HANDBOOK SERIES—VOLUME 2:

The Rudolf Report: Expert Report on Chemical and Technical Aspects of the 'Gas Chambers' of Auschwitz'

Revised and Expanded Second Edition

By GERMAR RUDOLF

Second revised and expanded edition edited by Dr. Wolfgang Lambrecht.
First edition translated from German by Carlos Porter, Michael Humphrey,
James Damon and the author.

Revised second edition by THE BARNES REVIEW: August 2011
First edition published in 2003 by Theses & Dissertations Press

ISBN: 978-0-9846312-7-8
ISSN: 1529-7748

Published by THE BARNES REVIEW
Copyright 2011 by THE BARNES REVIEW
Manufactured in the United States of America

Distribution USA/America:

THE BARNES REVIEW, P.O. Box 15877
Washington, D.C. 20003, USA
1-877-773-9077 toll free charge line

Distribution Europe/Africa: Castle Hill Publishers
P.O. Box 243
Uckfield, TN22 9AW, UK

Distribution Australia/Asia: Peace Books,
P.O. Box 3300, Norwood, 5067, Australia

www.BarnesReview.com • www.HolocaustHandbooks.com
If these sites are inaccessible, try it with anonymizer services.

Set in Times New Roman

ON THE COVER: Various photos show chemist Germar Rudolf during his on-site investigation on existing structures at the Auschwitz labor camp. This book is the result of his extensive scientific analysis of the data he gathered there.

Table of Contents

	Page
Part I: Science	9
1. Prelude.....	11
1.1. Slow Death in U.S. Gas Chambers	11
1.2. Hydrogen Cyanide – a Dangerous Poison.....	14
1.3. The Acid that Causes Blue Stains	19
2. The Coup	23
2.1. Fred Leuchter on Auschwitz and Majdanek	23
2.2. Damage Control	26
3. The Origins.....	29
3.1. On the Problem	31
3.2. On Politics.....	35
4. A Brief History of Forensic Examinations of Auschwitz.....	39
4.1. Introduction.....	39
4.2. The Moral Obligation of Forensic Examination	39
4.3. A Definition of Forensic Science.....	41
4.4. Forensic Science and Auschwitz.....	42
4.4.1. Forensics in the Courts	42
4.4.1.1. The 1946 Krakow Auschwitz Trial.....	42
4.4.1.2. The 1964-1966 Frankfurt Auschwitz Trial	44
4.4.1.3. The 1972 Vienna Auschwitz Trial	45
4.4.2. Forensics Outside the Courts.....	45
4.4.2.1. In Search of Mass Graves	45
4.4.2.2. Faurisson and the Consequences.....	46
5. Auschwitz.....	47
5.1. On the History of the Camp	47
5.2. Epidemics and the Defense Against Them	54
5.2.1. Danger of Epidemics.....	54
5.2.2. Epidemic Control with Zyklon B	55
5.2.3. Epidemic Control in Auschwitz	60
5.2.3.1. Terminology Used and Responsibilities	60
5.2.3.2. Procedures Used	62
5.2.3.3. Results	63
5.2.3.4. Basic Policy Decisions.....	63
5.2.3.5. The Army Medical Officer	64
5.2.3.6. Short-Wave Delousing Facility.....	67
5.2.4. Disinfestation Installations BW 5a und 5b.....	68
5.3. “Gas Chamber” in the Auschwitz I Main Camp	72
5.4. “Gas Chambers” in the Birkenau Camp.....	82
5.4.1. Crematoria II and III	82
5.4.1.1. Point of Departure.....	82
5.4.1.2. The Obsessive Search for “ <i>Criminal Traces</i> ”	87
5.4.1.2.1. New Cellars Stairways.....	88
5.4.1.2.2. Gassing Cellar, Undressing Room, and Showers.....	90
5.4.1.2.3. “ <i>Gas-tight Doors</i> ” for Crematorium II	93
5.4.1.2.4. Ventilation Installations.....	97
5.4.1.2.5. Pre-heated Morgues	99

5.4.1.2.6. “Cremation with Simultaneous Special Treatment“	99
5.4.1.2.7. “Gas Testers” and “Indicator Devices for HCN Residues”	101
5.4.1.2.8. Zyklon B Introduction Holes and Columns	104
5.4.1.2.9. Conclusions	122
5.4.2. Crematoria IV and V	123
5.4.3. Farmhouses 1 and 2	127
5.4.4. The Drainage System in Birkenau	129
5.4.4.1. Background: Eyewitness Accounts	129
5.4.4.2. The Ground Water Table in Birkenau	130
5.4.4.3. Open-Air Incineration in Pits	132
5.5. Construction Conclusions	133
6. Formation and Stability of Iron Blue	139
6.1. Introduction	139
6.2. Instances of Damage to Buildings	140
6.3. Properties of Hydrogen Cyanide, HCN	143
6.4. Composition of Iron Blue	145
6.4.1. Overview	145
6.4.2. Excursus	145
6.5. Formation of Iron Blue	147
6.5.1. Overview	147
6.5.2. Water Content	148
6.5.2.1. Overview	148
6.5.2.2. Excursus	148
6.5.3. Reactivity of Trivalent Iron	150
6.5.3.1. Overview	150
6.5.3.2. Excursus	150
6.5.4. Temperature	151
6.5.4.1. Overview	151
6.5.4.2. Excursus	153
6.5.5. Alkalinity	154
6.5.6. Carbon Dioxide	155
6.5.7. Conclusion	158
6.6. Stability of Iron Blue	159
6.6.1. pH Sensitivity	159
6.6.2. Solubility	160
6.6.2.1. Overview	160
6.6.2.2. Excursus	161
6.6.3. Excursus: Competing Ligands	164
6.6.4. Effects of Light	164
6.6.4.1. Overview	164
6.6.4.2. Excursus	165
6.6.5. Long-Term Test	166
6.7. Influence of Various Building Materials	168
6.7.1. Brick	168
6.7.1.1. Overview	168
6.7.1.2. Excursus	169
6.7.2. Cement Mortar and Concrete	169
6.7.2.1. Overview	169
6.7.2.2. Excursus	171

6.7.3. Lime Mortar	173
6.7.4. Effects upon the Formation of Iron Blue.....	173
7. Zyklon B for the Killing of Human Beings.....	179
7.1. Toxicological Effect of HCN.....	179
7.2. Evaporation Characteristics of Zyklon B.....	182
7.3. The Gassing of Human Beings	185
7.3.1. Eyewitness Testimonies	185
7.3.1.1. Boundary Conditions	185
7.3.1.2. Eyewitness Fantasies	185
7.3.1.3. Quantities of Poison Gas.....	193
7.3.1.3.1. Overview	193
7.3.1.3.2. Excursus 1: Poisoning or Suffocation?	196
7.3.1.3.3. Excursus 2: HCN Loss due to Adsorption	201
7.3.2. Critique of the Eyewitness Descriptions	203
7.3.2.1. Theatre of the Absurd	203
7.3.2.1.1. Necessity of Cooperation	203
7.3.2.1.2. Failure to Separate the Sexes	204
7.3.2.1.3. Towel and Soap	205
7.3.2.2. Speed of Ventilation of the “Gas Chambers”.....	205
7.3.2.2.1. Introduction	205
7.3.2.2.2. Excursus.....	206
7.3.2.2.3. Ventilation of the Morgues of Crematorium II and III.....	208
7.3.2.3. Simulation Calculations.....	212
7.3.2.4. Excursus: Capacity of Protective Filters.....	215
7.3.3. Evaluation of Eyewitnesses.....	218
7.3.4. An Expert on Cyanide Speaks Out.....	223
7.3.5. Why, Precisely, Zyklon B?.....	226
8. Evaluation of Chemical Analyses	230
8.1. Test Sample Taking and Description	230
8.2. Analytical Methods	231
8.3. Evaluation of Analytical Results.....	232
8.3.1. F.A. Leuchter/Alpha Analytic Laboratories	232
8.3.2. Institute for Forensic Research, Krakow	235
8.3.3. G. Rudolf/Fresenius Institute	238
8.3.3.1. Samples 1-4: Crematorium II, Morgue 1	243
8.3.3.2. Samples 5 to 8 and 23, 24: Inmate Barracks.....	244
8.3.3.3. Samples 9 to 22: Disinfestation Building.....	244
8.3.3.4. Samples 25-30: Tests	250
8.3.4. John C. Ball.....	253
8.4. Discussion of the Analysis Results	254
8.4.1. Blue Wall Paint?	254
8.4.2. False Method of Analysis.....	256
8.4.3. The Memory Hole	259
8.4.4. The Moon is Made of Pizza	262
8.4.5. Wikipedia – Wiki-Lies	267
8.4.6. Anticipated Values	267
8.4.7. Limits of the Chemical Method.....	272
9. Conclusions	275
10. Acknowledgements	279

Part II: Persecution: Hunting Gernar Rudolf	283
1. What Makes Revisionists?	285
2. The Naiveté of a Young Revisionist	303
3. Fleeing from England	316
4. Flaws of a State under the Rule of Law	355
5. Rudolf's "Thought Crimes"	369
5.1. The First Crime: Remer's Commentary	369
5.2. The Second Crime: A Scientific Anthology	391
5.3. More Thought Crimes... ..	393
6. The Media and the Case of Gernar Rudolf.....	399
7. Outlawed in Germany	419
8. Biographical Notes on the Author	437
Appendices	439
Lists	441
1. List of Tables	441
2. List of Illustrations	442
3. List of Graphs	446
4. List of Abbreviations	447
Index.....	449

* * *

Caveat Internet: Most of the revisionist literature quoted in this book can be downloaded free of charge from the Internet. The corresponding addresses have been given in the footnotes in some cases, all accessed in July 2010. Due to the evanescent nature of many Internet sources, however, there is no guarantee that the sources will still be at the same location when the reader tries to access them. In that case please use common sense and search engines to relocate them or to find similar sources about the issues they are meant to undergird. Most revisionist books and papers published in a revisionist periodical do not have an online address listed for space reasons, although many, if not most, are available online. In that case, please check whether the respective online file can be found at one of the two major revisionist online archives storing hundreds of revisionist books and periodicals¹ in html, pdf and ZIP format: www.vho.org and www.vho.org/aaargh (mirrored at www.aaargh.codoh.com). For a list of writings by Prof. R. Faurisson see at www.vho.org/aaargh/fran/archFaur/archFaurc.html.

¹ *Akribeia, Annales d'Histoire Revisionniste, Deutschland in Geschichte und Gegenwart, The Journal of Historical Review, The Revisionist, Revue d'Histoire Révisionniste, Smith's Report, Vierteljahreshefte für freie Geschichtsforschung.*

Part I: Science

1. Prelude

1.1. Slow Death in U.S. Gas Chambers

On June 15, 1994, dramatic events unfolded during the execution of capital punishment. David Lawson, sentenced to death for a capital felony, was scheduled to be killed by hydrogen cyanide in the gas chamber located in the state prison of Raleigh, North Carolina – but the prisoner refused to assist his executioners.² Lawson repeatedly held his breath for as long as possible and took only short breaths in between.³ Lawson exhibited enormous willpower, calling out to both executioners and witnesses throughout his execution:

“I am human.”

At first his cry was clearly audible, but as the minutes went by he became less and less understandable and finally, more than ten minutes into the execution, there was just a mutter. He was declared dead only after eighteen minutes. The witnesses to the execution were horrified.

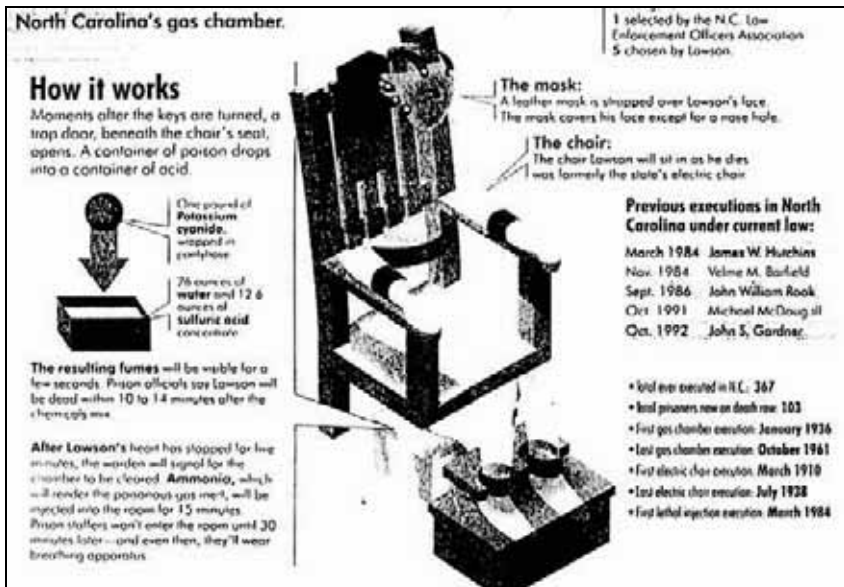

Fig. 1: Schematic drawing of the U.S. execution gas chamber in North Carolina.⁵

² A detailed description of this execution can be found at: Bill Krueger, “Lawson’s Final Moments,” *The News & Observer*, Raleigh, North Carolina, June 19, 1994, p. A1.

³ “Killing Me Cruelly,” *Newsweek*, November 8, 1993, p. 73; *The New York Times*, October 6, 1994, p. A20; *ibid.*, June 16, 1994, p. A23.

The warden of the prison who had also supervised the execution was so shaken that he resigned. Because of this execution fiasco, executions with poison gas have been abandoned for a short period of time in the USA and replaced with lethal injections.

In early March 1999, however, this horror had already been forgotten. This time, the victim was a German national. Despite intervention by the German government, Walter LaGrand was executed in the state prison at Florence, Arizona. LaGrand's death struggle against lethal cyanide gas lasted eighteen minutes. Thirty witnesses peered through a bulletproof window as the confessed, convicted murderer died horribly behind an armor-reinforced door.⁴

It is now clear to the experts, and especially to those still waiting on death row, that a quick and painless execution by gas requires the cooperation of the intended victim. Prisoners about to be gassed were usually encouraged to inhale deeply as soon as the cyanide was released in order to make their deaths come easily. However, if an intended victim was uncooperative, the execution could easily become a fiasco. By simply refusing to take the deep breaths needed to quickly inhale a lethal dose of cyanide, the agony could last for more than eighteen minutes, even under ideal conditions. Publications in the United States reveal that executions lasting from 10 to 14 minutes are the rule, rather than the exception. Amnesty International calls them "botched executions."⁵⁻⁸

The method used in American execution gas chambers was introduced in 1924, and has since been improved to technical perfection. The expense to kill just one single person is tremendously high, since neither the witnesses, nor the prison personnel or the environment may be endangered by the poison gas released for such an execution. Re-

⁴ Bettina Freitag, "Henker warten nicht," *New Yorker Staats-Zeitung*, March 13-19, 1999, p. 3.

⁵ *The News & Observer*, Raleigh (NC), June 11, 1994, p. 14A (according to the prison warden, normally 10-14 min.).

⁶ C.T. Duffy, *88 Men and 2 Women*, Doubleday, New York 1962, p. 101 (13-15 min.); C.T. Duffy was warden of San Quentin Prison for almost 12 years, during which time he ordered the execution of 88 men and 2 women, many of them executed in the local gas chamber.

⁷ Stephen Trombley, *The Execution Protocol*, Crown Publishers, New York 1992, p. 13 (approximately 10 minutes or more.); Amnesty International, *Botched Executions*, Fact Sheet December 1996, distributed by Amnesty International USA, 322 Eighth Avenue, New York, NY 10001-4808 (more than 7 min). See also more recently: Scott Christianson, *The Last Gasp. The Rise and Fall of the American Gas Chamber*, University of California Press, Berkeley, CA, 2010.

⁸ These paragraphs are based on an article by Conrad Grieb, "The Self-assisted Holocaust Hoax" (www.vho.org/GB/c/FPB/SelfAssisted.html); Ger.: "Der selbstassistierte Holocaust-Schwindel," *Vierteljahreshefte für freie Geschichtsforschung*, 1(1) (1997), pp. 6ff. (subsequently abbreviated as *VffG*).

inforced-glass windows, massive, heavy, hermetically-sealed steel doors, powerful ventilation systems with a device to burn the evacuated poisonous gases, and a chemical treatment of the chamber interior to neutralize all remaining traces of the poison make this execution method the most cumbersome of all.⁹

During the last two decades of the 20th century, the only technical expert in the United States able to build and maintain this equipment was Frederick A. Leuchter Jr., sometimes referred to in the media as “Mr. Death,”¹⁰ since his profession was the design, construction and maintenance of various kinds of execution devices.¹¹

A feature article in *The Atlantic Monthly* (Feb. 1990), for example, factually described Leuchter as

“the nation’s only commercial supplier of execution equipment. [...] A trained and accomplished engineer, he is versed in all types of execution equipment. He makes lethal-injection machines, gas chambers, and gallows, as well as electrocution systems [...]”

Similarly, a lengthy *New York Times* article (October 13, 1990), complete with a front-page photo of Leuchter, called him

“The nation’s leading adviser on capital punishment.”

In his book about “America’s Capital Punishment Industry,” Stephen Trombley confirms that Leuchter is, in fact,¹²

“America’s first and foremost supplier of execution hardware. His products include electric chairs, gas chambers, gallows, and lethal injection machines. He offers design, construction, installation, staff training and maintenance.”

Killing someone in a gas chamber is very dangerous for those who carry out the execution, above all because the body of the dead prisoner is saturated with lethal gas. After the execution, explains Leuchter:¹³

“You go in. The inmate has to be completely washed down with chlorine bleach or with ammonia. The poison exudes right out through his skin.

⁹ Re. the technical proceedings cf.: F.A. Leuchter, “The Third Leuchter Report,” in: F.A. Leuchter, R. Faurisson, G. Rudolf, *The Leuchter Reports. Critical Edition*, 2nd ed., The Barnes Review, Washington, DC, 2010, pp. 183-212.

¹⁰ Such is the title of a documentary movie directed by Errol Morris about Fred Leuchter, shown at the Sundance Film Festival in Park City (Utah, USA) on January 27, 1999: Errol Morris, *Mr. Death: The Rise and Fall of Fred A. Leuchter, Jr.*, Fourth Floor Productions, May 12, 1999; VHS: Universal Studios 2001; DVD: Lions Gate Home Entertainment, 2003 (www.video.google.com/videoplay?docid=654178281151939378). The original version first shown on Jan. 27, 1999, during the Sundance Film Festivals in Park City (Utah) has been reworked after protests.

¹¹ The following paragraphs were adapted from taken the paper “Probing Look at ‘Capital Punishment Industry’ Affirms Expertise of Auschwitz Investigator Leuchter,” *The Journal of Historical Review* 17(2) (1998), pp. 34ff. (subsequently abbreviated as *JHR*)

¹² Stephen Trombley, *op. cit.* (note 7), p. 8.

¹³ *Ibid.*, p. 98.

And if you gave the body to an undertaker, you'd kill the undertaker. You've got to go in, you've got to completely wash the body."

Bill Armontrout, warden of the Missouri State Penitentiary in Jefferson City, confirms the danger:¹⁴

"One of the things that cyanide gas does, it goes in the pores of your skin. You hose the body down, see. You have to use rubber gloves, and you hose the body down to decontaminate it before you do anything [else]"

In Leuchter's opinion, gas chamber use should be discontinued, not just because of the cruelty of this method of execution, but because of his beliefs relating to gas chambers as such:¹⁵

"They're dangerous. They're dangerous to the people who have to use them, and they're dangerous for the witnesses. They ought to take all of them and cut them in half with a chain saw and get rid of them."

With a career built on the motto "Capital punishment, not capital torture," Leuchter takes pride in his work. He is glad to be able to ensure that condemned prisoners die painlessly, that the personnel who carry out executions are not endangered, and that taxpayer dollars are saved.

1.2. Hydrogen Cyanide – a Dangerous Poison

Hydrogen cyanide, is not, of course, utilized solely for the purpose of executions in American gas chambers, but for much more constructive purposes as well. Since approximately the end of WWI, hydrogen cyanide, or HCN, has been used to exterminate vermin such as bedbugs, lice, corn weevils, termites, cockroaches, and other pests. It is, of course, important to be extremely cautious while applying hydrogen cyanide in order to avoid disaster, because it is in many ways a highly dangerous poison.

The residents of a house in Los Angeles, California, had to learn this in a quite painful way shortly before Christmas 1947. They had hired the Guarantee Fumigation Company to destroy the termites which threatened to eat up the wooden structure. The pest controllers, however, were apparently not very competent, because when using a container of pressurized HCN to fill the house, which had been wrapped up like a Christmas present, they exceeded safe limits and pumped in too much gas. (Fig. 2, p. 16).¹⁶ Due to unknown reasons, the mixture of air and HCN, which can be highly explosive under certain circumstances, ig-

¹⁴ *Ibid.*, p. 102

¹⁵ *Ibid.*, p. 13.

¹⁶ A gassing requires 1-2% by volume, while an explosion requires 6% by volume or more; see, in this regard, chapter 6.3.

nited during the fumigation. The resulting explosion destroyed the entire dwelling.¹⁷

However, hydrogen cyanide has yet another insidious characteristic: it is highly mobile. This mobility is highly welcome when it comes to killing vermin: Wherever fleas and bugs try to hide, the gas will still reach them! Unfortunately, hydrogen cyanide does not restrict itself to attack vermin. Rather, it indiscriminately seeps into the smallest cracks and even penetrates porous substances such as felt sealing materials and thin walls, thereby leaking into areas where it is not welcome. The failure on the part of disinfestors to ensure that all places to be fumigated are adequately sealed off have been described in toxicological literature:¹⁸

“Example: J.M., a 21 year old female home decorator, was working in the cellar of the house, the second floor of which was being treated for vermin with cyanide gas. Due to insufficient sealing during fumigation, the gas penetrated the corridors, where it poisoned the disinfestor, and reached the cellar through air shafts. Mrs. M. suddenly experienced an intense itching sensation in her throat followed by headache and dizziness. Her two fellow workers noticed the same symptoms and they all left the cellar. After half an hour, Mrs. M. returned to the cellar whereupon she suddenly collapsed and fell unconscious. Mrs. M. was taken to a hospital together with the unconscious exterminator. Mrs. M. recovered and was released. The exterminator, by contrast, was pronounced dead on arrival.”

But the dangers of this type of poison gas are not merely restricted to persons in the same house in which fumigation is taking place. Large quantities of gas may penetrate the open air and endanger the entire neighborhood, as shown by an accident in the fall of 1995 in a Croatian holiday resort:¹⁹

“That failed profoundly. Three local residents suffering from symptoms of poisoning and a number of surviving woodworms were the results of the botched action against vermin in a church in the Croatian holiday resort Lovran, close to Rijeka. The exterminator’s clumsy work necessitated the evacuation of several hundred residents of the locality.

¹⁷ “How to get rid of termites,” *Life*, Dec. 22, 1947, p. 31; see also *Liberty Bell*, 12/1994, pp. 36f.

¹⁸ Sven Moeschlin, *Klinik und Therapie der Vergiftung*, Georg Thieme Verlag, Stuttgart 1986, p. 300.

¹⁹ DPA, “Dilettantische Kammerjäger,” *Kreiszeitung – Böblinger Bote*, Nov. 16, 1995, p. 7. Research has failed to determine which toxic gas was involved. Since hydrogen cyanide is one of the most poisonous and most rapidly diffusing of all gases used in disinfestation, the reported damage would have been at least as great if caused by hydrogen cyanide, even if hydrogen cyanide was not in fact involved in this accident. A number of additional examples are described by K. Naumann: “Die Blausäurevergiftung bei der Schädlingsbekämpfung,” *Zeitschrift für hygienische Zoologie und Schädlingsbekämpfung*, 1941, pp. 36-45.

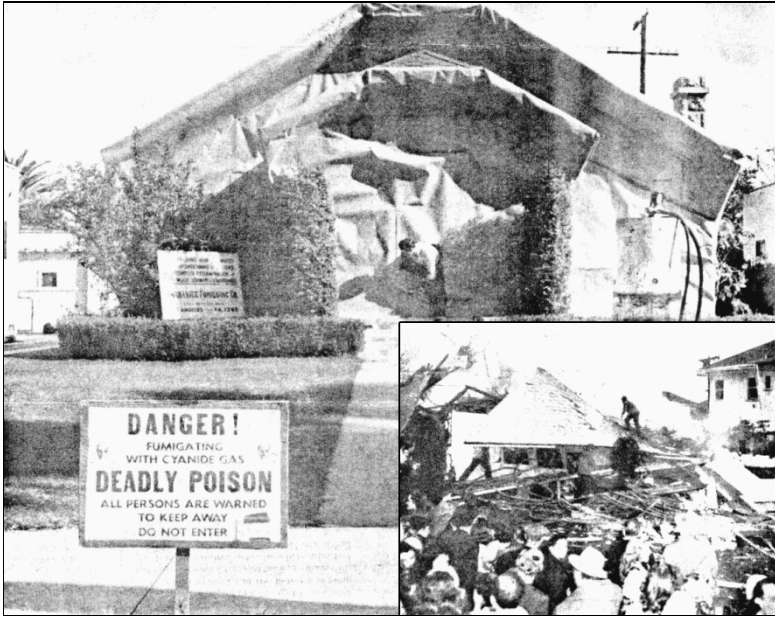

Fig. 2: How to get rid of termites: Larger photo: Before. Smaller photo: After.

The exterminators tried to treat the Church of the Holy Juraj for wood-worm during the night, using the highly toxic gas. But since they failed to seal off the church appropriately, the gas seeped into surrounding houses in which people were already asleep. 'Fortunately, the people woke up immediately because of sudden attacks of nausea – that's what saved them from certain death,' wrote the newspaper, 'Vecernji List.' Three residents nevertheless suffered severe intoxication. The mayor decided to evacuate the center of the town. The exterminators were arrested. The woodworms survived. DPA"

But that is still not all: on top of this, hydrogen cyanide is also a tenacious poison. It adheres wherever it is utilized, especially in a moist environment. Deadly cyanide gas continues to evaporate slowly from moist objects for hours and days, involving a permanent environmental hazard where sufficient ventilation cannot be assured. This is emphasized by an especially dramatic and simultaneously macabre accident in the United States in the fall of 1998:

Los Angeles Times

Oct. 13, 1998 | STEVE BALL, TIMES STAFF WRITER

9 Hurt After Student's Apparent Suicide by Cyanide

Toxic fumes produced when a college student from Orange County died of an apparent suicide Monday forced the evacuation of an Iowa dormitory and the hospitalization of nine people, authorities said.

Carl T. Grimm, 20, a sophomore from Placentia, ingested potassium cyanide about 7:30 a.m. in his dormitory room at Grinnell College, a private liberal arts school about 50 miles east of Des Moines, Iowa, Grinnell Fire Chief Jerry Barns said.

Four paramedics who responded to the call at Younkers Hall came in contact with fumes from the poison, as did two college staff members and three other students.

Grimm was taken to Grinnell Regional Medical Center, where he was pronounced dead. [...]

The others who became ill on the Iowa campus were treated and released from the hospital. [...]

Firefighters sent to the dormitory evacuated the three-story structure until the Des Moines Hazardous Materials Unit arrived to ventilate the building.

Authorities could not say immediately where or how Grimm acquired the potassium cyanide.^[20]

Another case, which occurred somewhat differently, nevertheless led to an accident which was no less tragic. Salts of cyanide, which release cyanide gas in the presence of moisture, are used for the separation of gold and silver during the processing of precious metals. In the case in question, a company was engaged in the processing of the cyanide-rich residues of such chemical reactions contained in large tanks, which is not without risk. The employer directed the workers, who were not equipped with gas masks or protective clothing, to go into the tanks which were still releasing cyanide gas. The consequences were tragic:

²⁰ <http://articles.latimes.com/1998/oct/13/local/me-32064>



Department of Justice

Department of Justice National News Release

MONDAY, MAY 10, 1999

On May 7, the jury in Pocatello, ID, found that Allan Elias ordered employees of Evergreen Resources, a fertilizer manufacturing company he owned, to enter and clean out a 25,000-gallon storage tank containing cyanide without taking required precautions to protect his employees. Occupational Safety and Health Administration inspectors repeatedly had warned Elias about the dangers of cyanide and explained the precautions he must take before sending his employees into the tank, such as testing for hazardous materials and giving workers protective gear.

Scott Dominguez, an Evergreen Resources employee, was overcome by hydrogen cyanide gas while cleaning the tank and sustained permanent brain damage as a result of cyanide poisoning.[...]

Over a period of two days in August 1996, Elias directed his employees – wearing only jeans and T-shirts – to enter an 11-foot-high, 36-foot-long storage tank and clean out cyanide waste from a mining operation he owned. Elias did not first test the material inside the tank for its toxicity, nor did he determine the amount of toxic gases present. After the first day of working inside the tank, several employees met with Elias and told him that working in the tank was giving them sore throats, which is an early symptom of exposure to hydrogen cyanide gas.

The employees asked Elias to test the air in the tank for toxic gases and bring them protective gear – which is required by OSHA and which was available to the defendant free of charge in this case. Elias did not provide the protective gear, and he ordered the employees to go back into the tank, falsely assuring them that he would get them the equipment they sought. Later that morning, Dominguez collapsed inside the tank. And he could not be rescued for nearly an hour because Elias also had not given employees the required rescue equipment.^[21]

²¹ Occupational Safety & Health Administration, news release, May 10, 1999; Allan Elias was sentenced to 17 years imprisonment on April 28, 2000, www.justice.gov/opa/pr/2000/April/239enrd.htm; an entire book has been written about the case: Joseph Hilldorfer, Robert Dugoni, *The Cyanide Canary*, Simon & Schuster, New York 2004. The cyanide-contaminated sludge in the tank also contained phosphoric acid, resulting in the release of cyanide gas.

Even this example fails to convey the full scope of the insidious nature of cyanide gas, since it does not just kill by means of inhalation; even a gas mask may prove insufficient, especially if a person is sweating heavily. Hydrogen cyanide is dissolved most readily on moist surfaces, and it easily penetrates the skin. This was proven by a dramatic accident in 1995 in a cave in the French city of Montérolier.²²

“The death of nine persons on June 21, 1995, in the cave of Montérolier (Seine-Maritime) was said to have been caused by the release of cyanide gas originating from the poison gas used during First World War, the so-called Vincennite. This was announced Wednesday by former Professor of Physical Chemistry, Louis Soulié. [...] At a press conference in Buchy, he said that ‘neither the children nor the firemen rushing to the rescue – one of whom wore a gas mask – died of carbon monoxide poisoning.’

[...] ‘Even six days after their deaths, a cyanide concentration twice as high as the fatal dose was still observed in the victims’ blood.’

According to the professor’s remarks, the three children lit a fire in the cave and threw a Vincennite bomb found in the cave into the fire. The bomb exploded. The gas caused the deaths of three children, four firemen, the father of one of the children and an amateur spelunker.

According to Prof. Soulié, the deaths of the firemen looking for the children in the cave, including the fireman wearing a gas mask, were due to the fact that hydrogen cyanide dissolves in the sweat and penetrates the body through the skin, where it causes poisoning.”

1.3. The Acid that Causes Blue Stains

Great excitement was caused by a strange occurrence in a Protestant church at Wiesenfeld, Lower Bavaria, Germany, in the spring and summer of 1977. The congregation had renovated the deteriorating church at great expense during the previous year, but now they faced a disaster. Huge blue stains were found to have formed in all parts of the plastered interior of the church. The experts having renovated the church were now called in for consultation, and found themselves confronted by a riddle which was only solved by a chemical analysis of the stained portions of the walls. The entire interior surface of the church was impregnated by Iron Blue.²³ No explanation could be found for this

²² “Un expert évoque la présence de gaz mortel dans la grotte,” *Le Quotidien de la Réunion*, June 25, 1998.

²³ Iron Blue is the ISO designation (ISO 2495) for iron cyanide blue pigments of various composition, which are also known as Berlin Blue, Turnbull’s Blue, Prussian Blue, Vossen Blue[®], Milori Blue, Paris Blue, French Blue, China Blue, Bronze Blue, Steel Blue, Ink Blue, among others, and as ferric ferrocyanide.

in the literature. It nevertheless proved possible to reconstruct the sequence of events.

A few weeks after the replastering of the church with a water-resistant cement mortar, the entire church had been fumigated with Zyklon B (hydrogen cyanide) to exterminate woodworm in the choir stalls. The hydrogen cyanide, released by the Zyklon B, did not just kill woodworm: it also reacted chemically with the plaster. The hydrogen cyanide contained in the Zyklon B reacted with the iron oxides contained in quantities of 1-2% in all plasters, thus forming Iron Blue, a highly stable compound well known for centuries.²⁴

Another case had occurred five years earlier in 1972 in the Catholic church of St. Michael in Untergriesbach, also in Bavaria. Here, too, the church had been recently refurbished with fresh plaster, which turned blue after the church had been gassed with Zyklon B to combat woodworms, just as it would happen in Wiesenfeld five years later.²⁵

Reports of blue pigmentation of walls resulting from fumigation with hydrogen cyanide for the destruction of vermin in areas with moist, ferrous plaster are not unknown in technical literature, as shown by a recent survey.²⁶ The necessary prerequisite for this reaction ap-



Fig. 3: In August 1976, the Protestant church at D-96484 Meeder-Wiesenfeld was fumigated with Zyklon B.

Subsequently, blue-colored stains appeared all over the plaster (see Fig. 4).

²⁴ G. Zimmermann (ed.), *Bauschäden Sammlung*, vol. 4, Forum-Verlag, Stuttgart 1981, pp. 120f., relating to the case of building damage occurring in August 1976 in the Protestant church at D-96484 Meeder-Wiesenfeld. We wish to thank Mr. W. Lüftl, Vienna, for discovering this information, as well as Mr. K. Fischer, Hochstadt am Main, who was held liable for damages as responsible architect, and who supplied me with further details. Reproduced from: G. Rudolf, "Wood Preservation through Fumigation with Hydrogen Cyanide: Blue Discoloration of Lime- and Cement-Based Interior Plaster," in: G. Rudolf (ed.), *Dissecting the Holocaust*, 2nd ed., Theses & Dissertations Press, Chicago 2003, pp. 557-561.

²⁵ www.pfarrei-untergriesbach.de/pfarrbrief11.htm.

²⁶ E. Emmerling, in: M. Petzet (ed.), *Holzschädlingsbekämpfung durch Begasung*, Arbeitshefte des Bayerischen Landesamtes für Denkmalpflege (Working Notebooks of the Bavarian State

pears to be that the fumigated plaster must be new and must exhibit high humidity. In other cases, there was also damage to the structure and interior installations, but no blue stains, perhaps because the plaster was old and had already set.²⁷

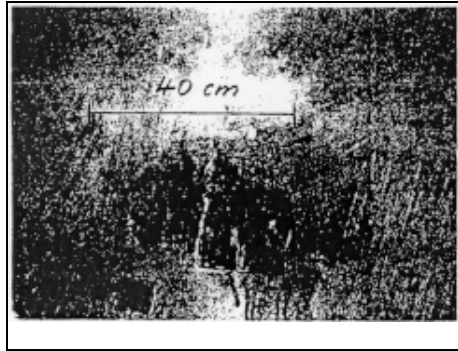

Fig. 4: Inky blue stains on the plaster of a church fumigated with hydrogen cyanide.

Office for Monument Maintenance), vol. 75, Lipp-Verlag, Munich 1995, pp. 43-56. Whether the examples cited in the paper may perhaps refer to the above mentioned case only in a roundabout way, must remain open for the time being. Carl Hermann Christmann reports the case of a farm building belonging to an 18th century monastery; the farm building was sold to a farmer following secularization, and the farmer then used it as a barn. Approximately 20 years ago, an investor converted the beautiful Baroque building into a luxury holiday restaurant. The existing interior plaster was repaired and painted white. After some time, blue stains appeared in the white paint; the stains were identified by a consulting expert as Iron Blue. The expert assumed that the former owner must have fumigated the building with hydrogen cyanide between 1920 and 1940, which then caused the stains 40-50 years later. Personal communication from C.H. Christmann according to his recollection on July 13, 1999; Mr. Christmann was unfortunately unable to find the source of the information. I would be extremely grateful for any references to passages in the literature in relation to this case.

²⁷ In one case, the fumigation of a church freshly painted with iron-free lime paint led to dark stains caused by the polymerization of hydrogen cyanide: D. Grosser, E. Roßmann, "Blausäuregas als bekämpfendes Holzschutzmittel für Kunstobjekte," *Holz als Roh- und Werkstoff*, 32 (1974), pp. 108-114.

2. The Coup

2.1. Fred Leuchter on Auschwitz and Majdanek

On February 3, 1988, Fred Leuchter received an unexpected visitor at his home in Boston, Massachusetts. A professor of French, Greek and Latin, as well as critic of testimonies, texts and documents, from the University of Lyon II – Dr. Robert Faurisson – had an unusual assignment in mind: He wanted to persuade Leuchter, in his capacity as an expert in execution technology, to prepare a professional opinion to be used in a criminal trial then taking place in Toronto, Canada.²⁸ More precisely, Dr. Faurisson wanted to convince Leuchter to determine whether or not the generally alleged mass exterminations with hydrogen cyanide gas in the concentration camps of the Third Reich were technically possible. Until that time, Leuchter had never questioned the existence of German homicidal gas chambers. When Prof. Faurisson showed him some mostly technical documents, however, Leuchter began to have doubts about the technical feasibility of the alleged homicidal gassings and agreed to come to Toronto to view additional documentation.

After this meeting and on the assignment of defense counsel, he then traveled to Poland with his wife (who was also his secretary), his draftsman, a video cameraman and a translator, to make a technical examination of the concentration camps at Auschwitz, Auschwitz-Birkenau and Majdanek for the above trial. He returned to the United States and wrote a 192-page report (including appendices). He also brought 32 test samples taken from the masonry in the crematoria at Auschwitz and Birkenau, the locations where the alleged gassings are said to have taken place, as well as from a delousing gas chamber. The background of these samples is as follows:

Almost all the concentration camps of the Third Reich contained facilities for the disinfestation of lice carried by inmate clothing. Various methods were used to accomplish this objective: hot air, hot steam, several different poison gases, and towards the end of the war even microwaves. Delousing was urgently needed in particular because lice

²⁸ Re. background and course of the criminal proceedings cf.: R. Lenski, *The Holocaust on Trial*, Reporter Press, Decatur, Alabama 1990, abridged transcript of the trial against Ernst Zündel in Toronto 1988; a lengthy compilation of the entire trial: Barbara Kulaszka (ed.), *Did Six Million Really Die? Report on the Evidence in the Canadian "False News" Trial of Ernst Zündel – 1988*, Samisdat Publishers Ltd., Toronto 1992.

carry epidemic typhus, a disease with a history of repeated outbreaks in eastern and central Europe. Epidemic typhus appeared again during WWII where it claimed hundreds of thousands of victims, not only in the concentration camps and prisoner-of-war camps, but among soldiers at the front. Since WWI, the most effective and the most widely used means for the extermination of lice and other pests, was hydrogen cyanide, marketed under the trade-name *Zyklon B*.

It has been known for decades that the walls within the buildings in which *Zyklon B* is proved to have been used to delouse inmate clothing exhibit massive, blotchy, bluish discoloration. This blue discoloration is due to a chemical substance known as *Iron Blue* which, under the right conditions, is formed in a chemical reaction by hydrogen cyanide with

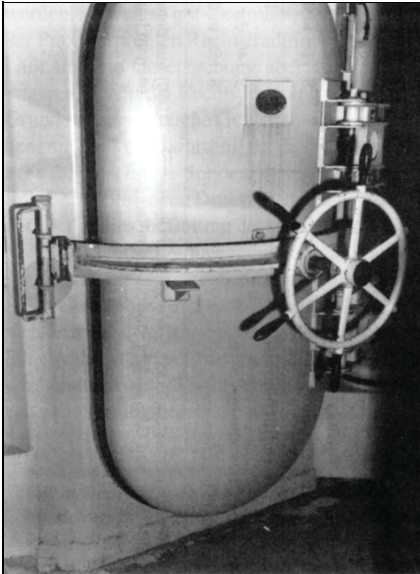

Fig. 5: Single door to an execution gas chamber for one single person per gassing procedure (Baltimore, USA, 1954, technology from the 1930s). The execution of a single person with hydrogen cyanide is inevitably far more complicated and dangerous to the environment than the fumigation of clothing (even in a Degesch²⁹ circulation chamber).



Fig. 6: One of three doors from an alleged National Socialist gas chamber for the execution of hundreds of persons simultaneously, using *Zyklon B* (hydrogen cyanide) (Crematorium I, Auschwitz, Poland, early 1940s). This door is neither of sturdy construction, nor is it air-tight (note the keyhole). It is partly glazed and opens inwards i.e., into the room, where corpses were allegedly piling up.

²⁹ Deutsche Gesellschaft für Schädlingsbekämpfung (German Society for Pest Control), a subsidiary of the I.G. Farbenindustrie AG.

certain components of masonry. This substance can still be observed in surviving delousing facilities today. It is obviously a very stable compound. Professor Faurisson was the first person to point out that this blue discoloration is absent from the supposed homicidal gas chambers at Auschwitz. Faurisson's idea was to analyze samples from the masonry in the alleged homicidal gas chambers for traces of poison gas or its compounds (cyanides) and compare them with samples taken from the delousing chambers.



Fig. 7: Frederick A. Leuchter, the world's first, and possibly only, cyanide gas chamber expert, during a talk at the conference of the Institute for Historical Review in 1992

Fred Leuchter followed this suggestion when doing his on-site investigations in Auschwitz in 1988.

On April 20 and 21, 1988, Leuchter took the stand as an expert witness in the courtroom in Toronto. He reported about his research and developed his conclusions. The atmosphere in the courtroom was tense. Leuchter's testimony was straightforward and at the same time sensational: According to Leuchter, there had never been any possibility of mass extermination of human beings by gassing either in Auschwitz, or in Birkenau, or in Majdanek.³⁰

"It is the best engineering opinion of this author that the alleged gas chambers at the inspected sites could not have then been, or now, be utilized or seriously considered to function as execution gas chambers."

Shortly before Leuchter, another witness was questioned: Bill Armontrout, warden of the Maximum Security Prison in Jefferson City, Missouri. It was Armontrout who, on request of defense attorney Barbara Kulaszka, pointed out that no one in the United States understood the operation of gas chambers better than Fred A. Leuchter. Armontrout himself confirmed in court the great difficulties involved in killing people with poison gas, as Robert Faurisson had done before him.

³⁰ F. A. Leuchter, *An Engineering Report on the Alleged Execution Gas Chambers at Auschwitz, Birkenau and Majdanek, Poland*, Samisdat Publishers Ltd., Toronto 1988; new: F.A. Leuchter, "The First Leuchter Report," in: F.A. Leuchter et al., op. cit. (note 9), pp. 13-119, here p. 57.

Following Leuchter, Prof. James Roth, director of a chemical laboratory in Massachusetts, also took the witness stand to describe the results of his analysis of the 32 masonry samples, the origins of which had been unknown to him: All samples taken from the gas chambers supposedly used for mass human extermination exhibited either no or only negligible traces of cyanide, while the sample from the delousing chambers taken as a control exhibited enormously high cyanide concentrations.³¹

Leuchter's report and subsequent testimony shook the foundations of Holocaust history, the story of the "Nazi gas chambers." Considering the tens of thousands of copies of this Leuchter Report that have been distributed in all major languages all over the world and the many speeches Leuchter held, the impact of the work of this one man was enormous.

2.2. Damage Control

Alarmed by this development, the "Never Forgive, Never Forget" brigade wasted no time in taking counter-measures. Self-styled "Nazi hunter" Beate Klarsfeld announced that Fred Leuchter "has to understand that in denying the Holocaust, he cannot remain unpunished."³²

Jewish organizations launched a vicious smear campaign to destroy not only his reputation, but his ability to make a living. Leading the charge was Shelly Shapiro and her group, "Holocaust Survivors and Friends in Pursuit of Justice." Calling Leuchter a fraud and impostor, this group claimed, despite better knowledge, that he lacked qualifications as an execution equipment specialist and had asserted the possession of professional qualifications which he had never earned.³³

Although these accusations were entirely unfounded and failed to survive any legal verification, the "get Leuchter" campaign, with the co-operation of mainstream journalists and editors, was successful. Leuchter's contracts with state authorities for the manufacture, installation, and servicing of execution hardware were cancelled. He was financially forced out of his home in Massachusetts and had to find pri-

³¹ Partially derived from Prof. Faurisson's description in: R. Faurisson, "The End of a Myth," *JHR*, 8(3) (1988), pp. 376-380; R. Faurisson, "The Zündel Trials (1985 and 1988)," *ibid.*, 8(4) (1988), pp. 417-431.

³² This paragraph is again taken from the paper quoted above (note 11), which gives no reference for this alleged quote of Beate Klarsfeld.

³³ Cf. *JHR*, 12(4) (1992), pp. 421-492.

vate work elsewhere. No American has suffered more for his defiance of the Holocaust lobby.

3. The Origins

Before the publication of the *Leuchter Report*, discussion relating to the reliability of eyewitness testimony of National Socialist mass murder was confined to groups describing themselves as “revisionists,” usually termed “Neo-Nazis” or “right-wing extremists” by the media. But in fact, the labels used by the media were wide of the mark, as can be seen in the case of four of the most well-known revisionists: Paul Rassinier, French Socialist and former member of the French Resistance, who was an inmate of the concentration camps Buchenwald and Dora-Mittelbau;³⁴ German Jew Josef Ginsburg, who suffered from anti-Jewish measures taken during WWII by other countries as well as Germany.³⁵ The two most notable revisionists, Professors Arthur R. Butz, USA,³⁶ and retired Prof. Robert Faurisson, of France, can certainly not be accused of being political extremists, and nobody ever seriously tried to do this.³⁷



Fig. 8: Prof. Dr. Robert Faurisson

The discussion on the technical problems of the National Socialist mass-murder of the Jews was begun in the late 1970s by Robert Faurisson, then professor of French, Greek and Latin, and an analyst of documents, texts, and witness statements at the University of Lyon II. He began to question the standard historical version of the Holocaust after he had made numerous critical studies concerning witness testimony and on documents that supposedly supported the claims of mass-murder. In 1978 for the first time, he advanced the argument that “there had not been one single

³⁴ Some of his most important works were also published in English, see *The Real Eichmann Trial or the Incurable Victors*, Torrance, CA, 1976; *Debunking the Genocide Myth*, The Noonday Press, Los Angeles, 1978; *The Holocaust Story and the Lies of Ulysses*, 2nd ed., Institute for Historical Review, New Port Beach 1990.

³⁵ Some of his most important works (all in German) are available online at www.vho.org/dl/DEU.html#jdd.

³⁶ Cf. *The Hoax of the Twentieth Century*, 3rd ed., Theses & Dissertations Press, Chicago 2003; “Context and perspective in the ‘Holocaust’ controversy,” *JHR*, 3(4) (1982), pp. 371-405.

³⁷ Cf. *Mémoire en défense*, La Vieille Taupe, Paris 1980; Serge Thion (ed.), *Vérité historique ou vérité politique?*; La Vieille Taupe, Paris 1980; R. Faurisson, *Écrits révisionnistes*, 4 vols., published by author, Vichy 1999.

gas chamber under Adolf Hitler.”³⁸ Later he supported this claim with physical, chemical, topographic, architectural, documentary, and historical arguments. He described the existence of the homicidal gas chambers as “radically impossible.”³⁹ At the end of 1979, the largest French daily newspaper, *Le Monde*, decided to publish Professor Faurisson’s provocative thesis, so he was given the opportunity to summarize it in an article.⁴⁰ The establishment historians’ reaction was characteristic⁴¹ and is best illustrated by a passage from a declaration signed by Pierre Vidal Naquet and 33 other researchers:⁴²

“One may not ask how such a mass-murder [of Jews] was possible. It was technically possible, because it happened. This is the obligatory starting-point of every historical investigation of this subject. We simply want to call into memory this truth: There is no debate over the existence of the gas chambers, and there must not be one.”

Such a dogmatic explanation is equivalent to a capitulation, which was well understood. Hence they reconsidered their standpoint and went back to the drawing board.

Over the years that followed, establishment historians took up the questions raised by Robert Faurisson and others, at least to some extent, although they doggedly refused to permit him, or any one else who even remotely voiced similar thoughts, to participate in any academic activities. In the early 1980s, two large Holocaust conferences were held in the cities of Paris⁴³ and Stuttgart.⁴⁴ Some of the more important reasons for these conferences certainly were the works of Faurisson, Butz and others.⁴⁵

³⁸ Cf. in addition to arguments in the works in note 37 also R. Faurisson, “Es gab keine Gaskammern,” Deutscher Arbeitskreis Witten, Witten 1978.

³⁹ R. Faurisson, “Le camere a gas non sono mai esistite,” *Storia illustrata*, 261 (1979), pp. 15-35; Engl.: “The Gas Chambers: Truth or Lie?” *The Journal of Historical Review*, 2(4) (1981), pp. 319-373; cf. Faurisson, “The Mechanics of Gassing,” *JHR*, 1(1) (1980) pp. 23ff.; Faurisson, “The Gas Chambers of Auschwitz Appear to be Physically Inconceivable,” *ibid.*, 2(4) (1981), pp. 311ff.

⁴⁰ “Le problème des chambres à gaz” ou ‘la rumeur d’Auschwitz,” *Le Monde*, Dec. 29, 1978, p. 8; see also “The ‘problem of the gas chambers,’” *JHR*, 1(2) (1980), pp. 103-114 (ihr.org/jhr/v01/v01p103_Faurisson.html).

⁴¹ Cf. the documentation on numerous articles and letters in R. Faurisson, *Mémoire...*, *op. cit.* (note 37), pp. 71-101.

⁴² *Le Monde*, Feb 21, 1979.

⁴³ At the Sorbonne from Jun 29. – July 2, 1982, entitled “Le national-socialisme et les Juifs”; cf. Ecole des hautes études en sciences sociales (ed.), *L’Allemagne nazie et le génocide juif*, Gallimard/Le Seuil, Paris 1985; on December 11-13, 1987, there was a second Colloquium held at the Sorbonne, cf. R. Faurisson, *Écrits révisionnistes*, *op. cit.* (note 37), vol. 2, pp. 733-750.

⁴⁴ For a transcript of the conference, cf.: E. Jäckel, J. Rohwer, *Der Mord an den Juden im Zweiten Weltkrieg*, Deutsche Verlags-Anstalt, Stuttgart 1985.

⁴⁵ Most importantly, Wilhelm Stäglich’s *Der Auschwitz-Mythos*, Grabert, Tübingen 1979; Engl.: *The Auschwitz Myth*, Institute for Historical Review, Torrance, CA, 1986; as well as Walter N.

In 1983, as a counter-measure against the ongoing successes of revisionists, a compilation was published, principally the work of French and German establishment historians.⁴⁶ While this book ridiculed and insulted revisionists and cast political aspersions against them, and at the same time was intended to refute their claims, it does neither address any particular revisionist argument, nor are any revisionist publications quoted or authors named, so that it is impossible for the reader of this book to verify the polemic accusations made against the revisionists. This book also repeats the mistake often emphasized by revisionists: quotations from “eyewitness” testimony and passages from documents were taken out of context and pasted uncritically into a pre-determined historical pattern.

The publication of the *Leuchter Report* at the end of the 1980s gave a significant boost to revisionism. From that time onward, there has been an unending stream of publications.⁴⁷ The number of persons involved in “revisionism” increases steadily; although in many European countries this development has been curtailed by the enactment of laws threatening heavy penalties.⁴⁸

3.1. On the Problem

A fact-oriented discussion of the technical arguments brought into the public by the *Leuchter Report* was started in France by an attempt at refutation by the pharmacist Jean-Claude Pressac in the periodical *Jour*

Sanning’s papers and book on Jewish population statistics: “Die europäischen Juden. Eine technische Studie zur zahlenmäßigen Entwicklung im Zweiten Weltkrieg,” 4 parts, *Deutschland in Geschichte und Gegenwart* 28(1-4) (1980), pp. 12-15; 17-21; 17-21; 25-31; Sanning, *Die Auflösung des osteuropäischen Judentums*, Grabert, Tübingen 1983; English: *The Dissolution of Eastern European Jewry*, Institute for Historical Review, Torrance, CA, 1983.

⁴⁶ E. Kogon, H. Langbein, A. Rückerl et al. (eds.), *Nationalsozialistische Massentötungen durch Giftgas*, S. Fischer Verlag, Frankfurt 1983; Engl.: *Nazi Mass Murder*, Yale University Press, New Haven 1993; French: Henry Rollet (ed.), *Les chambres à gaz: secret d’Etat*, Les Editions de Minuit, Paris 1984.

⁴⁷ Since a complete listing of them all is impossible here, the reader’s attention may be directed to the expanding series *Holocaust Handbooks* and the literature quoted in them; see the ads at the end of this book (www.HolocaustHandbooks.com).

⁴⁸ The Fabius-Gayssot Law was passed in France in 1990, rendering punishable the “denial of the facts” of the National Socialist war crimes “ascertained” at the Nuremberg Trials of 1946 convened by the Allied powers. In 1993, Austria followed suit (sec. 3h Criminal Law); in 1994, Germany (sec. 130 Criminal Code, new version), in 1995, Switzerland (sec. 216^{bis} Criminal Code) and in 1996, Spain enacted similar laws that year, but abrogated it in 2007. A similar law passed in Belgium in 1997. Poland adopted a similar law in 1999, Czechia in 2001, and Hungary in 2010. Canada and Australia have created “Human Rights Commissions” which persecute revisionists and other offenders against political correctness. For more details see http://en.wikipedia.org/wiki/Laws_against_Holocaust_denial.

Juij.⁴⁹ His work could hardly qualify as an expert discussion in view of the absence of any references to his sources and any exact scientific argumentation. Though he did point out several deficiencies in the *Leuchter Report*, he made several errors himself in chemical and engineering questions due to his lack of expertise.⁵⁰

The first response from Germany came from the official *Institut für Zeitgeschichte* (IfZ, Institute for Contemporary History).⁵¹ It was based on Pressac's work and was hardly useful due to the lack of technical expertise in the same.⁵²

A little later, a contribution on the *Leuchter Report* appeared in an anthology on the Third Reich, authored by retired social worker Werner Wegner, who had no qualifications in chemistry or civil engineering either.⁵³ Instead of seeking the advice of qualified people on these matters, he drew his own conclusions – to his own massive embarrassment.⁵⁴ One may question why Dr. Rainer Zitelmann, the responsible editor of this anthology, included this ridiculous piece in his otherwise well-researched compilation.⁵⁵

At the end of 1991, chemist Dr. J. Bailer critiqued the *Leuchter Report* in a little booklet published in Austria.⁵⁶ This work is notable for largely ignoring the witness testimony on the procedures supposedly

⁴⁹ J.-C. Pressac, *Jour J*, December 12, 1988, pp. I-X. See also the related discussion in the undated translation, without references; see also Pressac in: S. Shapiro (ed.), *Truth Prevails: Demolishing Holocaust Denial: The End of the Leuchter Report*, Beate Klarsfeld Foundation, New York 1990.

⁵⁰ On this cf. W. Schuster, "Technische Unmöglichkeiten bei Pressac," *Deutschland in Geschichte und Gegenwart*, 39(2) (1991), pp. 9-13; also Paul Grubach, "The Leuchter Report Vindicated: A Response to Jean-Claude Pressac's Critique," *JHR*, 12(4) (1992), pp. 445-473.

⁵¹ H. Auerbach, Institut für Zeitgeschichte, letter to Bundesprüfstelle, Munich, Oct. 10, 1989; Auerbach, November 1989 (no day given), both published in U. Walendy, *Historische Tatsache* no. 42, Verlag für Volkstum und Zeitgeschichtsforschung, Vlotho 1990, pp. 32 and 34.

⁵² In this regard, see my technical appraisal, reprinted in Henri Roques, Günter Anthon, *Der Fall Günter Deckert*, DAGD/Germania Verlag, Weinheim 1995, pp. 431-435.

⁵³ W. Wegner, "Keine Massenvergasungen in Auschwitz? Zur Kritik des Leuchter-Gutachtens," in U. Backes, E. Jesse, R. Zitelmann (ed.), *Die Schatten der Vergangenheit*, Propyläen, Frankfurt 1990, pp. 450-476 (www.vho.org/D/dsdv/Wegner.html, with inserted critique by the present writer).

⁵⁴ On this cf. W. Häberle, "Zu Wegners Kritik am Leuchter-Gutachten," *Deutschland in Geschichte und Gegenwart*, 39(2) (1991), pp. 13-17.

⁵⁵ In a personal communication to me, he confessed that he had been forced to include the paper to avoid opposition to his book due to the fact that the other papers were "revisionist" in tone.

⁵⁶ J. Bailer, "Der Leuchter-Bericht aus der Sicht eines Chemikers," in: Dokumentationszentrum des österreichischen Widerstandes, Bundesministerium für Unterricht und Kultur (eds.), *Amoklauf gegen die Wirklichkeit*, Vienna 1991, pp. 47-52. With respect to the cyanide content of human hair: Expert Opinion of the Krakow Institute, 1945, on the cyanide content of human hair, hair pins and a ventilation lid, B. Bailer-Galanda, *ibid.*, pp. 36-40; the original is in the custody of the Auschwitz State Museum.

used during the gassings at Auschwitz and for the author's lack of understanding of the process by which hydrogen cyanide reacts with masonry. Despite criticism directed at his study,⁵⁷ Bailer repeated his unsustainable objections in a later publication without responding to his critics.⁵⁸

At approximately the same time as Bailer's first publication, G. Wellers also published a study of the *Leuchter Report*.⁵⁹ Wellers' position was superficial, and is characterized by lack of technical and scientific knowledge.⁶⁰

Finally, the Auschwitz State Museum itself ordered an expert report to be compiled. The Institute for Forensic Research, Toxicology Division, of Krakow, Poland, named after Prof. Dr. Jan Sehn, prepared this report under Prof. Dr. J. Markiewicz on September 24, 1990, which confined itself to the analysis of masonry samples.⁶¹ The report concluded that the reason why Leuchter's samples from the homicidal gas chambers were mostly negative with respect to traces of cyanide was because the cyanide compounds had been exposed for more than 40 years to weathering, which these compounds allegedly could not have withstood. Three of these authors from the Jan Sehn Institute later published additional findings,⁶² which were, however, based on a verifiably incorrect analytical method – as was the first series of analyses – so that their results were flawed.⁶³ Correspondence with the authors failed to elucidate the reasons for the deliberate use of an incorrect method.⁶⁴

In 1997 in France, distribution of the French edition of an earlier version of this present report produced two notable reactions, only one

⁵⁷ Cf. E. Gauss (= G. Rudolf), *Vorlesungen über Zeitgeschichte*, Grabert, Tübingen 1993, pp. 290-293; idem, "Chemische Wissenschaft zur Gaskammerfrage," *Deutschland in Geschichte und Gegenwart*, 41(2) (1993), pp. 16-24.

⁵⁸ J. Bailer, in B. Bailer-Galanda, W. Benz, W. Neugebauer (ed.), *Wahrheit und Auschwitzlüge*, Deuticke, Vienna 1995, pp. 112-118; cf. my critique "Lüge und Auschwitz-Wahrheit," in G. Rudolf, C. Mattogno, *Auschwitz-Lügen*, Castle Hill Publishers, Hastings 2005, pp. 185-227; Engl.: "Critique of *Truth and the Auschwitz-Lie*" (www.vho.org/GB/Books/cq/critique.html).

⁵⁹ G. Wellers, "Der Leuchter-Bericht über die Gaskammern von Auschwitz," *Dachauer Hefte*, 7(7) (November 1991), pp. 230-241.

⁶⁰ Cf. my critique "Fantasies of a Biochemist," in G. Rudolf, C. Mattogno, *Auschwitz-Lies*, Theses & Dissertations Press, Chicago 2005, pp. 35-43.

⁶¹ J. Markiewicz, W. Gubala, J. Labedz, B. Trzcinska, Expert Opinion, Prof. Dr. Jan Sehn Institute for Forensic Research, department for toxicology, Krakow, Sept. 24, 1990; partially published, e.g. in: "An official Polish report on the Auschwitz 'gas chambers,'" *JHR*, 11(2) (1991), pp. 207-216.

⁶² J. Markiewicz, W. Gubala, J. Labedz, *Z Zagadnien Nauk Sadowych*, Z XXX (1994) pp. 17-27 (www2.ca.nizkor.org/ftp.cgi/orgs/polish/institute-for-forensic-research/post-leuchter.report).

⁶³ G. Rudolf, "Polish Pseudo-Scientists," in G. Rudolf, C. Mattogno, op. cit. (note 60), pp. 45-68.

⁶⁴ *Ibid.*, pp. 57-65.

of which addressed factual arguments,⁶⁵ but which nevertheless failed to discuss the technical problems in a scientific manner.⁶⁶ The Chemical Department of the French Academy of Sciences chose not to make a comment publicly on factual arguments, but rather to resort to polemic phraseology and personal attacks.⁶⁷

In 1998, in the United States, in answer to the present report, a paper appeared on the Internet, which partly discusses technical issues and partly consists of political name-calling.⁶⁸ In related correspondence,⁶⁹ however, the author of the paper avoided any discussion of the central issues.⁷⁰

In 1999, cultural historian Prof. Robert Jan van Pelt produced an expert report on Auschwitz for the defense in the libel case of British Historian David Irving against American writer Deborah Lipstadt.⁷¹ This report represents a retreat to the argumentative situation *before* Jean-Claude Pressac's first book, published in 1989,⁷² ignoring almost all arguments brought forward by revisionists since that year.⁷³ In 2002 van Pelt's expert report appeared in a revised and extended version as a book.⁷⁴ It is the first book in English to intensively discuss various revi-

⁶⁵ B. Clair, "Revisionistische Gutachten," *VffG*, 1(2) (1997), pp. 102-104.

⁶⁶ G. Rudolf, "Zur Kritik am Rudolf Gutachten," *ibid.*, pp. 104-108.

⁶⁷ La Vielle Taupe/Pierre Guillaume, "Rudolf Gutachten: 'psychopathologisch und gefährlich.' Über die Psychopathologie einer Erklärung," *VffG*, 1(4) (1997), pp. 224f.

⁶⁸ Richard J. Green, "The Chemistry of Auschwitz," May 10, 1998, online: holocaust-history.org/auschwitz/chemistry/, and "Leuchter, Rudolf and the Iron Blues," March 25, 1998, www.holocaust-history.org/auschwitz/chemistry/blue/, with considerable proselytizing "anti-fascist" bias.

⁶⁹ A detailed description of the deficiencies of the paper appeared in "Das Rudolf Gutachten in der Kritik, Teil 2," *VffG* 3(1) (1999), pp. 77-82; Engl.: "Some considerations about the 'Gas Chambers' of Auschwitz and Birkenau," online: www.vho.org/GB/c/GR/Green.html.

⁷⁰ Richard J. Green, Jamie McCarthy, "Chemistry is Not the Science," May 2, 1999, www.holocaust-history.org/auschwitz/chemistry/not-the-science/. About a third of the article consists of political accusations and vilification. For a response, see G. Rudolf, "Character Assassins," www.vho.org/GB/c/GR/CharacterAssassins.html; cf. "Green sees Red," in: G. Rudolf, C. Mattogno, op. cit. (note 60), pp. 69-85.

⁷¹ *The Pelt Report*, introduced in evidence during the libel case before the Queen's Bench Division, Royal Courts of Justice, Strand, London, David John Cawdell Irving vs. (1) Penguin Books Limited, (2) Deborah E. Lipstadt, ref. 1996 I. No. 1113 (www.holocaustdenialonline.org/en/trial/defense/van).

⁷² Jean-Claude Pressac, *Auschwitz: Technique and operation of the gas chambers*, Beate-Klarsfeld-Foundation, New York 1989 (www.holocaust-history.org/auschwitz/pressac/technique-and-operation/).

⁷³ Cf. G. Rudolf, "Gutachter und Urteilsschelte," *VffG* 4(1) (2000), pp. 33-50; more exhaustively in English: "Critique of Claims Made by Robert Jan van Pelt," www.vho.org/GB/c/GR/RudolfOnVanPelt.html and "Critique of the 'Findings on Justification' by Judge Gray," www.vho.org/GB/c/GR/CritiqueGray.html.

⁷⁴ Robert J. van Pelt, *The Case for Auschwitz. Evidence from the Irving Trial*, Indiana University Press, Bloomington/Indianapolis 2002; cf. Samuel Crowell, "A Holocaust Expert Moves from Moral Certainty toward Open Debate," *JHR*, 21(1) (2002), pp. 39f.; Robert H. Countess, "van

sionist arguments, although it fails to mention even one of the many books and papers written by the most industrious and productive revisionist researchers, Carlo Mattogno. Van Pelt mainly relied on the works of J.-C. Pressac for his own book, even though he hardly ever mentions him.⁷⁵ It is a pity that the cultural historian van Pelt tries to address many chemical, toxicological, engineering and architectural questions for which he simply lacks both expertise and experience. But even when it comes to analyzing the historical record, van Pelt falls far short of the requirements for a serious study, as Mattogno has concluded in his 750 pp. analysis of van Pelt's tome.⁷⁶

“[van Pelt's] *study of Auschwitz has no scientific and historiographic value,*

- *because it ignores works of crucial importance;*
- *because it does not even mention essential opposing views and arguments;*
- *because it fails to approach pivotal technical issues with technical means;*
- *because it is highly inconsistent;*
- *because it uses deceptive methods;*
- *because it presents conflicting sources without due source criticism;*
- *because it reveals a decidedly threadbare knowledge of the camp's history;*
- *because it deforms all sources to serve the alleged 'extermination' aspects of Auschwitz;*
- *and because even regarding the claimed 'extermination' aspects it exhibits an incomplete and superficial grasp.”*

Most of the above-mentioned attempted refutations of the *Leuchter Report*, and subsequent discussion with other revisionists, are marred by personal insinuations about the motivations of persons making use of revisionist arguments, or by polemical excursions, neither of which contribute to the scientific discussion.

3.2. On Politics

The question of whether or not systematic mass-killings of Jews in homicidal gas chambers specifically constructed for the purpose of ac-

Pelt's Plea against Sound Reasoning,” *The Revisionist* 1(1) (2003), pp. 99-104; Paul Grubach, “World War I Atrocity Propaganda and the Holocaust,” *ibid.*, pp. 104-109.

⁷⁵ When he addresses chemical questions, he also refers to some degree to the work of R. Green, *op. cit.* (notes 68, 70).

⁷⁶ Carlo Mattogno, *Auschwitz: The Case for Sanity*, The Barnes Review, Washington, DC, 2010, p. 670.

completing their extermination took place under the National Socialist regime is apparently viewed as a political issue. Whether or not a moral appraisal of the National Socialist regime depends on the existence or non-existence of gas chambers is disputable. A political evaluation of the Third Reich is not significantly dependent upon this moral evaluation. Since the present discussion contains neither a moral, nor political, evaluation of a long-dead regime, I shall make no moral or political statements. Personally, I am inclined to judge a politician, or political system, on the basis of what s/he, or it, was able to leave behind for their respective nation – everything else follows. That must suffice at this point.

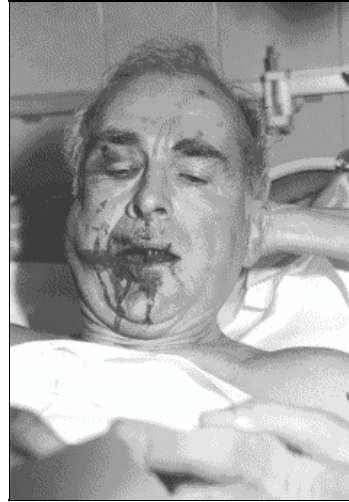

Fig. 9: *People who run out of arguments turn to violence. Prof. Faurisson after an attack by Jewish thugs, Sept. 16, 1989.⁷⁷*

To everyone who has ever suspected that revisionists are motivated by a desire to whitewash National Socialism, or restore the acceptability of right-wing political systems, or assist in a breakthrough of Nationalism, I would like to say the following:

While researching, our highest goal must at all times be to discover how historical events actually occurred – as the 19th century German historian Leopold Ranke maintained. Historians should not place research in the service of making criminal accusations against, for example, Genghis Khan and the Mongol hordes, nor to whitewash any of their wrong-doings. Anybody insisting that research be barred from exonerating Genghis Khan of criminal accusations would be the object of ridicule and would be subject to the suspicion that he was, in fact, acting out of political motives. If this were not so, why would anyone insist that our historical view of Genghis Khan forever be defined solely by Khan's victims and enemies?

The same reasoning applies to Hitler and the Third Reich. Both revisionists and their adversaries are entitled to their political views. The accusation that revisionists are only interested in exonerating National

⁷⁷ *The Globe and Mail*, Sept. 18, 1989, *Le Monde*, Sept. 19, 1989, *Sunday Telegraph*, Sept. 24, 1989; see also "Revisionist Historian Suffers Savage Beating" (www.codoh.com/thoughtcrimes/8909FAUR.HTML).

Socialism and that such an effort is reprehensible or even criminal, is a boomerang: This accusation implies that it is deemed unacceptable to partially exonerate National Socialism historically, and by so doing, always also morally. But by declaring any hypothetical exoneration based on possible facts as unacceptable, one admits openly not to be interested in the quest for the truth, but in incriminating National Socialism historically and morally under any circumstances and at all costs. And the motivation behind this can *only* be political. Hence, those accusing revisionists of misusing their research for political ends have themselves been proven guilty of exactly this offense. It is therefore not necessarily the revisionists who are guided by political motives – though quite a few of them certainly are – but with absolute certainty all those who accuse others of attempting to somehow historically exonerate a political system which has long since disappeared.

As a consequence, our research must never be concerned with the possible “moral” spin-off effects of our findings in relation to politicians or regimes of the past or present, but solely with the facts. Anyone who argues the opposite does not understand scientific research and should not presume to condemn others on the basis of authentic research.

4. A Brief History of Forensic Examinations of Auschwitz

4.1. Introduction

In late spring 1993, the Max Planck Institute for Solid State Research in Stuttgart issued an internal memorandum informing its employees that a doctoral candidate there – the author of this book – had been dismissed because of private research he had done on Auschwitz. The institute explained that in view of the horror of the National Socialists' crimes against the Jews, it was morally repugnant to discuss the specific manner in which the victims had been killed, or to try to determine the precise number of the dead. Hence one of the world's leading scientific research institutes stated to its personnel that it is not only unethical, but reprehensible and a cause for dismissal, should they dare to determine accurate quantities and causes. This is not without its own irony. However, many people are deeply moved by the question whether or not the monstrous crime alleged should be subject to careful scrutiny by means of thorough forensic analysis. The following is an attempt to answer this question by offering a brief overview on forensic examinations of the purported crime scenes at Auschwitz which have been conducted thus far.

4.2. The Moral Obligation of Forensic Examination

Does it really matter how many Jews lost their lives in the German sphere of influence during the Second World War? Is it so important, after so many years, to attempt painstakingly to investigate just how they died? After all, it is surely morally correct that even one victim is one too many; and nobody seriously denies that many Jews died.

To affirm these things, however, is not to raise a valid objection – moral or otherwise – to the scientific investigation of a crime held to be unique and unparalleled in the history of mankind. Even a crime that is alleged to be uniquely reprehensible must be open to a procedure that is standard for any other crime: namely, that it can be – must be – subject to a detailed material investigation. Further: whoever postulates that a crime, alleged or actual, is unique must be prepared for a uniquely thorough investigation of the alleged crime before its uniqueness is accepted as fact.

If, on the other hand, someone sought to shield so allegedly unparalleled a crime from investigation by erecting a taboo of moral outrage, the creators of that taboo would, at least morally, themselves commit a singular offense: imputing unparalleled guilt, beyond any critique and defense, in this case to an entire people, the Germans.

To demonstrate just what kind of double standard is being applied to “the Holocaust” (generally defined as the purposeful annihilation, chiefly by gassing, of millions of Jews by the National Socialists), let us note the international reaction to several recent examples of mass murder or “crimes against humanity.”

In 1949, a trial started in southwest France which caused as much attention in France as did the Nuremberg War Crimes Trial: Mdm. Marie Besnard was accused of having murdered twelve people with arsenic. During this extraordinary court battle, 15 experts on medical, chemical, geological and analytical forensic experts made exhaustive analyses and long-lasting, extensive experiments with the aim to verify whether the arsenic traces found in the buried victims stemmed from poison or are the result of yet unknown concentration processes in buried corpses. Finally, after twelve years of research and arguing of the fifteen experts, of which eight were professors and one even a Nobel Prize laureate, Mdm. Besnard was acquitted due to lack of evidence.⁷⁸

After the collapse of the Soviet Union in 1991, numerous mass graves, containing altogether hundreds of thousands of bodies of victims of the Soviets, were discovered, excavated, and investigated. Not only was the number of victims determined, but in many cases the specific cause of death as well. In the same regions where many of these mass graves were found, one million Jews are said to have been shot by the *Einsatzgruppen*. Yet no such grave has ever been reported found, let alone dug and investigated, in the more than half a century during which these areas have been controlled by the USSR and its successor states.

During the conflict in Kosovo in 1999, rumors about mass killings by Serbs spread around the world. After the fighting was over, an international forensic commission arrived in Kosovo, searching, excavating and forensically investigating mass graves. These graves proved to be not only fewer than the Serbs' Albanian opponents had alleged, but to contain small fractions of the number of victims claimed.

⁷⁸ Michael D. Kelleher, C. L. Kelleher, *Murder Most Rare: The Female Serial Killer*, Praeger, Westport, Conn., 1998.

Did the Allies attempt, during the Second World War and in the years immediately following, to find and to investigate mass graves of persons said to have been victims of the Germans? So far as is known, only once: at Katyn. But the findings of the Soviet forensic commission, which blamed the mass murder of several thousand Polish officers buried there on the Germans, are today generally considered a fabrication. The report of the international forensic commission invited by the Germans in 1943, on the other hand, which found that the Soviets had carried out this mass murder, is today considered accurate even by the Russian government.⁷⁹

4.3. A Definition of Forensic Science

Forensic science is generally regarded as a supporting science of criminology. Its aim is to collect and to identify physical remnants of a crime, and from these to draw conclusions about the victim(s), the perpetrator(s), the weapon(s), time and location of the crime as well as how it was committed, if at all. This science is relatively new and entered the courtrooms only in 1902, when fingerprint evidence was accepted, in an English court, for the first time. The 1998 CD-ROM *Encyclopedia Britannica* writes about forensic science:

“A broad range of scientific techniques is available to law enforcement agencies attempting to identify suspects or to establish beyond doubt the connection between a suspect and the crime in question. Examples include the analysis of bloodstains and traces of other body fluids (such as semen or spittle) that may indicate some of the characteristics of the offender. Fibres can be analyzed by microscopy or chemical analysis to show, for instance, that fibres found on the victim or at the scene of the crime are similar to those in the clothing of the suspect. Hair samples, and particularly skin cells attached to hair roots, can be compared chemically and genetically to those of the suspect. Many inorganic substances, such as glass, paper, and paint, can yield considerable information under microscopic or chemical analysis. Examination of a document in question may reveal it to be a forgery, on the evidence that the paper on which it is written was manufactured by a technique not available at the time to which it allegedly dates. The refractive index of even small particles of glass may be measured to show that a given item or fragment of glass was part of a particular batch manufactured at a particular time and place.”

Hence, forensic research is exactly what revisionists, starting with Robert Faurisson, have called the search for material evidence. The

⁷⁹ Cf. George Sanford, *Katyn and the Soviet Massacre of 1940*, Routledge, Oxford 2005.

revisionists' demand for such material evidence is entirely consistent with the normal practice of modern law enforcement. Also, as is generally acknowledged, forensic evidence is more conclusive than eyewitness testimony or documentary evidence.

Even though forensic methods have hardly been applied with regards to Auschwitz, there are a few examples which I shall discuss briefly in the following chapter.

4.4. Forensic Science and Auschwitz

4.4.1. Forensics in the Courts

4.4.1.1. The 1946 Krakow Auschwitz Trial

In 1945, the Jan Sehn Institute for Forensic Research (Instytut Ekspertyz Sadowych) prepared a report on a forensic investigation of Auschwitz that was submitted in evidence in the 1946 Auschwitz trial in Krakow, Poland.⁸⁰ This expert report should be treated with caution, because forensic examinations and judicial procedures under the Communists have been anything but trustworthy, and in 1945, Poland was a Stalinist satellite. One need only point to the example of Katyn, the Soviet account of which was fully endorsed by Poland's Communist regime.⁷⁹

The Krakow forensic investigators took hair, presumably cut from inmates, and hair clasps from bags found by the Soviets in Auschwitz. Tested for cyanide residues, both hair and clasps showed positive results. Additionally, a zinc-plated metal cover was tested for cyanide and found to have a positive result as well. The Krakow Institute claims that this metal cover once shielded the exhaust duct of a supposed homicidal gas chamber at Birkenau.

The tests conducted by the institute were qualitative, not quantitative, analyses. In other words, they could only determine whether or not cyanide was present, not how much of it was there. As to whether or not homicidal gassing with hydrogen cyanide took place in Auschwitz, these analyses are worthless, for three reasons:

1. There is no way of determining the origin and history of the hair and hair clasps obtained from bags in Auschwitz. Assuming that the analytic results are correct, from a chemical point of view the following can be noted: A positive test for cyanide in human hair

⁸⁰ Published in German, *op. cit.* (note 56), pp. 36-40; the original is in the Auschwitz State Museum.

proves only that the hair has been exposed to HCN (hydrogen cyanide). But that result does not suffice to establish that the persons from whom the hair came were killed by cyanide. It is a good deal more likely that the hair had already been cut when it was exposed to the gas: in German as well as in Allied camps, it was standard to cut off prisoners' hair for hygienic reasons. When hair over a certain length was later reused,⁸¹ it had to be deloused beforehand (often with Zyklon B, the active ingredient of which is hydrogen cyanide). Hence, positive cyanide results from loose hair do not prove human gassings.

2. We face a similar problem with the zinc-plated covers allegedly used to cover the ventilation ducts of the supposed gas chambers: their exact origin and history is unknown. It would have been much preferable for the Krakow Institute to have analyzed samples from the walls of the alleged gas chambers instead of obtaining samples from pieces of metal:
 - a. Whereas the origin and history of these metal covers are uncertain, the origin and (at least partly) the history of the walls of the morgues allegedly used as gas chambers are known.
 - b. In contrast to cement and concrete, zinc-plated metal covers prevent the formation of stable iron cyanide compounds.⁸² The developing zinc cyanide compounds are relatively unstable and must be expected to vanish in a short period of time.⁸³
 - c. The tendency of porous wall material in moist underground rooms to accumulate and to bind hydrogen cyanide, physically as well as chemically, is hundreds of times higher than that of sheet metal (see chapter 6.7.).
 - d. As a matter of fact, the letter accompanying the samples sent to the Krakow Institute actually mentions that a mortar sample allegedly taken from a so-called gas chamber is enclosed as well and should also be tested for cyanide. However, for unknown reasons, the Krakow Institute did not mention this mortar sample in its report, perhaps because it did not show any positive result.

⁸¹ Letter from the SS-Wirtschafts- und Verwaltungshauptamt, Oranienburg, to concentration camp commanders, August 6, 1942, IMT document USSR-511, cited in: International Military Tribunal, *Trial of the Major War Criminals* (hereafter *IMT*), Nuremberg 1947 (www.avalon.law.yale.edu/subject_menus/imt.asp), Aug. 5, 1946, vol. 20. The letter ordered the recycling of prisoners' hair twenty centimeters or more in length; but see also the critical remarks by Carlos W. Porter, www.cwporter.com/gussr511.htm.

⁸² Zinc prevents the formation of rust, which is required to form long-term stable iron cyanides.

⁸³ Like earth alkaline cyanides, zinc cyanides are slowly decomposed by humidity.

3. It is unknown where those zinc-plated metal covers are today. It is furthermore impossible to identify them, since the Krakow report does not include a description or photo of them. Therefore, this analysis cannot be reproduced.

4.4.1.2. The 1964-1966 Frankfurt Auschwitz Trial

Several expert reports were prepared during the Frankfurt Auschwitz trial, the best known being those of the Munich *Institut für Zeitgeschichte* (Institute for Contemporary History).⁸⁴ However, none of these reports was forensic in nature. They addressed legal, historical, or psychological topics. Throughout this mammoth trial, the court, the prosecution⁸⁵ and the defense⁸⁶ never suggested that material traces of the alleged crime be secured and investigated. The prosecution had at its disposal numerous statements by eyewitnesses and confessions by perpetrators, and it considered this material entirely sufficient to establish beyond reasonable doubt the existence of a program to exterminate Jews at Auschwitz and elsewhere during the Third Reich.⁸⁷ The abundance of such evidence has since been used to argue that the lack of documentary and material evidence is irrelevant.⁸⁸ That no material evidence was presented during the Frankfurt Auschwitz Trial was freely conceded by the court in its ruling:⁸⁸

“The court lacked almost all possibilities of discovery available in a normal murder trial to create a true picture of the actual event at the time of the murder. It lacked the bodies of the victims, autopsy records, expert reports on the cause of death and the time of death; it lacked any trace of

⁸⁴ H. Buchheim, M. Broszat, H.-A. Jacobsen, H. Krausnick, *Anatomie des SS-Staates*, 2 vols., Walter Verlag, Freiburg 1964.

⁸⁵ Throughout his writings, Adalbert Rückerl, one of the most prominent German prosecutors in “Holocaust cases,” dispenses with any mention of material evidence. Instead, he declares documentary evidence the best and most important form of evidence, even in the absence of material evidence for the authenticity and correctness of the documents themselves (in Jürgen Weber, P. Steinbach (eds.), *Vergangenheitsbewältigung durch Strafverfahren?*, Olzog, Munich 1984, p. 77). Rückerl reports that it is practically impossible to find a suspect guilty solely on documentary evidence, so that, especially given the increasing time span separating alleged crimes from trial, it is almost always necessary to fall back on eyewitness testimony, even though its unreliability is clear, particularly in trials of so-called “National Socialist violent crimes” (A. Rückerl, *NS-Verbrechen vor Gericht*, C. F. Müller, Heidelberg 1984, p. 249; Rückerl, *Nationalsozialistische Vernichtungslager im Spiegel deutscher Strafprozesse*, dtv, Munich 1978, p. 34; Rückerl, *NS-Prozesse*, C. F. Müller, Karlsruhe 1972, pp. 27, 29, 31).

⁸⁶ Such total naiveté, combined with legal incompetence, on behalf of the defense is best exemplified in Hans Laternser, *Die andere Seite im Auschwitzprozeß 1963/65*, Seewald, Stuttgart 1966.

⁸⁷ One of the most prominent German advocates of this thesis is Professor Ernst Nolte in his book *Streitpunkte*, Propyläen, Berlin 1993, pp. 290, 293, 297.

⁸⁸ Ref. 50/4 Ks 2/63; cf. I. Sagel-Grande, H. H. Fuchs, C. F. Rüter (eds.), *Justiz und NS-Verbrechen*, vol. 21, University Press, Amsterdam 1979, p. 434.

the murderers, murder weapons, etc. An examination of the eyewitness testimony was only possible in rare cases. Where the slightest doubt existed or the possibility of a confusion could not be excluded with certainty, the court did not evaluate the testimony of witnesses [...]"

4.4.1.3. The 1972 Vienna Auschwitz Trial

Between January 18 and March 10, 1972, two architects responsible for the design and construction of the crematoria in Auschwitz-Birkenau, Walter Dejaco and Fritz Ertl, were put on trial in Vienna, Austria.⁸⁹ During the trial, an expert report on the possible interpretation of the blueprints of the alleged gas chambers of the Auschwitz and Birkenau crematoria was presented to the court. The report concluded that the rooms in question could not have been gas chambers, nor could they have been converted into gas chambers.⁹⁰ Thanks to this first methodologically sound expert report on Auschwitz, the defendants were acquitted.

4.4.2. Forensics Outside the Courts

4.4.2.1. In Search of Mass Graves

In 1966 the Auschwitz State Museum commissioned the Polish company Hydrokop to drill into the soil of the Auschwitz-Birkenau camp and to analyze the samples. It is not known whether this research was done in the context of the Frankfurt Auschwitz trial. The results, however, vanished into the museum's archives: they have never been released, which by itself is revealing enough. Years later, however, several pages from this report were photocopied and sent to the German revisionist publisher Udo Walendy, who published them with commentary in an issue of his periodical.⁹¹ Traces of bones and hair allegedly found at several places might indicate mass graves. The few pages published by Walendy, however, do not reveal whether these findings led to an excavation or a subsequent forensic study of the traces. It is not even evident whether the bone and hair samples collected are human or animal remains. (Since Birkenau had a butchery to provide the camp with

⁸⁹ Ref. 20 Vr 6575/72 (Hv56/72), Jan. 18-March 10, 1972; this reference number is different from the one Robert van Pelt quotes in his report: *The Pelt Report, op. cit.* (note 71), p. 135 n. 59: 20 Vr 3806/64 and 27 C Vr 3806/64).

⁹⁰ Personal communications by Walter Lüfl who interviewed the expert, who must, for the time being, remain anonymous for fear of persecution and prosecution. See Michael Gärtner (=W. Lüfl), "Vor 25 Jahren: Ein anderer Auschwitzprozeß," *VffG*, 1(1) (1997), pp. 24f.

⁹¹ Udo Walendy, *Historische Tatsachen*, no. 60, Verlag für Volkstum und Zeitgeschichtsforschung, Vlotho 1993, pp. 7-10.

meat, animal offal might have been disposed in garbage trenches in the camp's vicinity.⁹²⁾

4.4.2.2. Faurisson and the Consequences

As a result of Prof. Faurisson's activities as described in chapter 3, forensic research on Auschwitz boomed since 1988. Each time a researcher came to a conclusion contradicting the widely held views, he was socially ostracized and persecuted, like Prof. Faurisson, Fred Leuchter and Germar Rudolf, but when the results confirmed the reigning paradigms, the researchers were darlings of the media and politicians, like Jean-Claude Pressac, the researchers from the Jan Sehn Institute in Krakow, and more recently Prof. Robert van Pelt.⁷⁴

It must therefore be stated that forensic research on Auschwitz is not at all reprehensible, as stated by the Max Planck Institute in Stuttgart. Such research was always done, more or less intensively. What is often considered to be reprehensible, however, is a research *result* that is unwanted by the public. This is an unfortunate bias, because science can prosper only where any result is openly and freely published and discussed without researchers fearing punitive measures.

The present book is an attempt to give the reader an update about the results of the ongoing forensic research on the two major camps of Auschwitz, the *Stammlager* or main camp close to the town of Auschwitz itself, and the *Birkenau* camp some 3 km to the northwest of the town. May it *not* lead to more persecution and ostracism of its author than he already has experienced.⁹³

⁹² C. Mattogno, "Auschwitz – 60 Jahre Propaganda," *Vierteljahreshefte für freie Geschichtsforschung*, 9(2), (2005), pp. 171f.; "Bestandplan des provisorischen Schlachthauses BW 33B," *GARF*, 7021-108-48, p. 14.

⁹³ For this, see the appendix at the end of this book.

5. Auschwitz

5.1. On the History of the Camp

Although the name of Auschwitz, a town in Polish Upper Silesia, is utilized as a synonym for the alleged National Socialist crime of an assembly-line extermination of Jews – frequently described as “unique” – thus far, worldwide, there has never been any balanced description of this concentration camp. Generally, only three books, from the thousands on the subject, are worth selecting for discussion here.

Danuta Czech’s *Kalendarium*, a work of post-war Polish-Communist propaganda, resembles a sort of catalogue of chronological listing of actual and invented individual events, without any attempt to draw up a critical view of the existing material on the history of the camp.⁹⁴

Jean-Claude Pressac’s works concentrate almost exclusively on only five buildings in the camp, the crematoria,^{72,95} but due to his lack of technical and architectural expertise, he nevertheless fails miserably in his self-appointed task of explaining the technique and manner of functioning of these buildings.⁹⁶

Robert van Pelt and Deborah Dwork, in their history of the city of Auschwitz, deal only superficially with the subject of the concentration camp,⁹⁷ and van Pelt’s more recent book⁷⁴ is narrowly focused on homicidal gassings, does not really go beyond what Pressac already presented, and exhibits a crass inaptitude to deal with the historical documentation.⁷⁶

⁹⁴ *Kalendarium der Ereignisse im Konzentrationslager Auschwitz-Birkenau 1939-1945*, Rowohlt, Reinbek bei Hamburg, 1989; Engl.: *Auschwitz Chronicle, 1939-1945*, H. Holt, New York 1990.

⁹⁵ J.-C. Pressac, *Les crématoires d’Auschwitz. La machinerie du meurtre de masse*, CNSR, Paris 1993; German: *Die Krematorien von Auschwitz. Die Technik des Massenmordes*, Piper, Munich 1994; if not mentioned otherwise, back references to this footnote refer to the French original.

⁹⁶ For a criticism of Pressac’s first book, see R. Faurisson, *JHR*, 11(1) (1991), pp. 25-66; *ibid.*, 11(2) (1991), pp. 133-175; F.A. Leuchter, “The Fourth Leuchter Report,” in: F.A. Leuchter et al., op. cit. (note 9), pp. 213-230; for a critique of Pressac’s second book see: G. Rudolf (ed.), *Auschwitz: Plain Facts*, Theses & Dissertations Press, Chicago 2005; for a critique of the principles underlying Pressac’s method, see G. Rudolf, “Pressac: From Paul to Pseudo-Saul,” in: G. Rudolf, C. Mattogno, op. cit. (note 60), pp. 28-32; for a general critique see also C. Mattogno, op. cit. (note 76); Pressac has since been the target of massive, quite unscientific attacks from Jewish quarters as well; see also *Rivarol*, March 22, 1996, p. 8; *ibid.*, April 12, 1996, p. 4; see also Pierre Guillaume’s criticism, *De la misère intellectuelle en milieu universitaire*, B.p. 9805, 75224 Paris cedex 05, 1995 (www.aaargh.codoh.com/fran/archVT/vt97/vt9309xx1.html).

⁹⁷ Robert van Pelt, Deborah Dwork, *Auschwitz: 1270 to the Present*, Yale University Press, New Haven and London 1996; see also Carlo Mattogno’s critique “Architektonische Stümpereien zweier Plagiatoren,” *VffG*, 4(1) (2000), pp. 25-33; Engl.: “Auschwitz 1270 to the Present,” www.vho.org/GB/c/CM/irving-eng.html.

Books available on bookstore shelves are – for the most part – a compendium of eyewitness reports, scattered amongst serious attempts at documentation and literary pretensions.⁹⁸

Only in the very early 1990s, *i.e.*, since the collapse of the Communist regime in Eastern Europe, did the files of those agencies of the Third Reich become available to us which allow a reliable history of the Auschwitz camp to be written. The files of the *Zentralbauleitung der Waffen SS und Polizei Auschwitz* (Central Construction Office of the Waffen SS and Police at Auschwitz), which are located in Moscow,⁹⁹ the files of the *Kriegsarchiv der Waffen SS* (War Archive of the Waffen SS) in the Military-Historical Archives in Prague, and the files of Auschwitz concentration camp, which are located at the Auschwitz Museum, are especially important in this regard. Since there are more than one hundred thousand documents in these archives, it will be necessary to wait for several years for the appearance of a seriously documented work on the topic. It must be considered certain that such research, which is only just beginning, will lead to a further massive revision of our image of the Auschwitz concentration camp.¹⁰⁰

In the absence of better documentation, in the following – as far as the brief survey of the history of Auschwitz is concerned – I will rely upon the statements of Jean-Claude Pressac,^{72,95} where his statements are undisputed. Where corrections are necessary, I resort to the extensive research results by Carlo Mattogno.¹⁰⁰

The installations of the Auschwitz I camp, also known as the *Stamm-lager* (main camp) and located on the outskirts of the city of Auschwitz, originally formed part of the barracks of the Austrian-Hungarian Monarchy (later Poland), and were transformed into a concentration camp

⁹⁸ See, in this regard, Norman G. Finkelstein's condemnation in Norman G. Finkelstein, Ruth Bettina Birn, *A Nation on Trial: The Goldhagen Thesis and Historical Truth*, Metropolitan Books, New York 1998; see also Richard Widmann, "Holocaust Literature vs. holocaust scholarship: Thoughts on Finkelstein, Goldhagen and Holocaust Revisionism," *The Revisionist*, no. 1, 2000.

⁹⁹ Rossiiskii Gosudarstvennii Vojennii Archiv (Russian national war archives, hereafter RGVA), Moscow; in earlier years this archive bore the name "Tsentral'nii Istoriko-dokumental'nyi Kollektiv"; see also the documents in the Gosudarstvennyi Archiv Rossiiskoy Federatsii (National archives of the Russian federation, hereafter GARF).

¹⁰⁰ Carlo Mattogno has started an ambitious series about various aspects of the Auschwitz camp, currently comprising the titles: *Special Treatment in Auschwitz. Origin and Meaning of a Term* (2004); *The Bunkers of Auschwitz. Black Propaganda versus History* (2004); *Auschwitz: Open Air Incinerations* (2005); *Auschwitz: Crematorium I and the Alleged Homicidal Gassings* (2005); *The Central Construction Office of the Waffen-SS and Police Auschwitz* (2005) *Auschwitz: The First Gassing. Rumor and Reality* (2005) (all Theses & Dissertations Press, Chicago); and in the making: *The Crematory Ovens of Auschwitz and Healthcare in Auschwitz* (both planned for 2011, The Barnes Review, Washington DC).

after the German invasion of Poland in September 1939. Camp II, located in the vicinity of the village of Birkenau (known as Auschwitz-Birkenau) was erected after the start of the Russian campaign, officially as a Waffen SS prisoner of war camp for the reception of Russian POWs. Both camps belonged to the same complex, with over 30 additional smaller camps in Upper Silesia, intended to supply manpower in the form of forced labor for the industries in the area, among them the chemical works recently built by the Germans on a large scale at Auschwitz, in particular the Buna works of the German industrial giant *I.G. Farbenindustrie AG* for coal refining (liquefaction and gasification plants for artificial rubber and fuel production), located close to the settlement Monowitz east of Auschwitz, see Fig. 10. Birkenau camp was used, among other things, for the reception of unfit prisoners. The intended camp capacity of 200,000, according to the final planning situation, was unique among the concentration camps of the Third Reich. This capacity was, however, never even approximately achieved.

Cramming together large numbers of people in the most restricted areas of camps whose sanitary infrastructure were just being developed caused serious health problems in all camps of the Third Reich. Both inmates and hundreds of civilians working in the camps could introduce all sorts of parasitic insects into the camp, in particular lice and fleas. Lice are the chief carriers of epidemic typhus, which was a widespread disease in Eastern Europe. Therefore, the camps were equipped with hygienic installations, including extensive disinfestation installations, in which the clothing and personal effects of newly arriving inmates were disinfested, for instance with the insecticide Zyklon B (a porous carrier material soaked with liquid hydrogen cyanide), a product frequently used for this purpose. The inmates themselves were given a haircut¹⁰¹ and were made to shower thoroughly. Since the camp was at times insufficiently equipped with disinfestation installations and materials, also aided by carelessness during disinfestation on the part of civilians working in the camp, typhus epidemics broke out, repeatedly killing large numbers of inmates as well as guards.

Due to the high mortality rate, these camps were equipped with cremation facilities. After a devastating typhus epidemic had broken out in summer 1942, during which more than 300 people died per day at peak times, plans were made to build four cremation facilities at Birkenau in the hope of being able to cope with the amount of corpses. Of these four

¹⁰¹ In the Third Reich, hair cut to a certain length is alleged to have been collected for industrial purposes, after previous delousing, see note 81.

crematoria, however, two were severely damaged shortly after they were put into operation. Since it turned out that the capacity of the four Birkenau crematoria was much higher than needed, the two damaged crematoria were not repaired but were allowed to remain idle. The main camp in Auschwitz possessed only one crematorium installation which was put out of operation with the opening of the installations at Birkenau.

Historians today usually assume that the above mentioned cremation installations were not only used for the purpose initially planned, *i.e.*, the incineration of inmates having died of natural causes, but were later misused for the mass extermination of the Jews, among others. According to these historians, the term “*arbeitsunfähig*” (unfit for labor), used in relation to prisoners, was equivalent in meaning to “undeserving of life.” This implies that any arriving inmates who were unable to work were killed immediately. For this purpose, human beings are said to have been killed (“gassed”) in certain rooms of the crematoria after a few structural modifications. This was allegedly done using Zyklon B, which was originally intended exclusively for vermin control. After their alleged murder, the victims are said to have been burnt, some of them in the cremation ovens and some in open ditches.

According to eyewitness accounts, a homicidal gas chamber is supposed to have existed in the crematorium of Auschwitz I (main camp); this location still exists today, intact, but has been the object of serious manipulation, as we shall see. Additional homicidal gas chambers are said to have existed in the Birkenau camp, Auschwitz II, located approximately three kilometers away. These gas chambers were allegedly located in the four crematoria of that camp, as well as in two farmhouses outside the actual camp itself, which had been modified for homicidal gassing purposes.

Of the installations used for disinfestation in the Birkenau camp *using Zyklon B*, only buildings 5a and b (BW 5a/b) in construction sections 1a/b (*Bauabschnitt* 1a/b) remain intact. In these buildings, one wing each is said to have been temporarily used for the disinfestation of personal effects with hydrogen cyanide. The following chapters 5.2.-5.5. will describe architectural and structural features of the individual structures of the Auschwitz main camp and Birkenau. Maps of these camps are reproduced in Figs. 11 and 12.

Fig. 10: Map of the surrounding vicinity of Auschwitz during the Second World War. The boundary lines of the terrain of the IG Farbenindustrie factories were entered later, and are only an approximate indication of the factory terrain. The terrain of Birkenau concentration camp corresponds to the planning situation of 1945, which was, in fact, never completed.

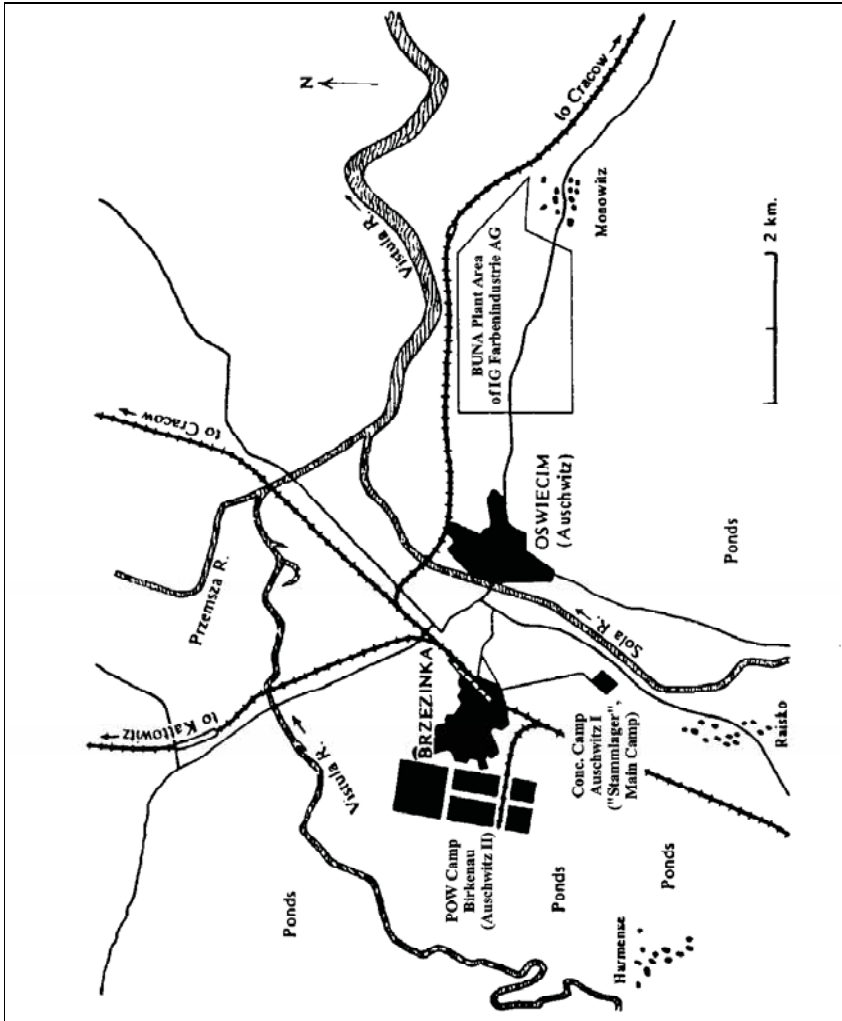

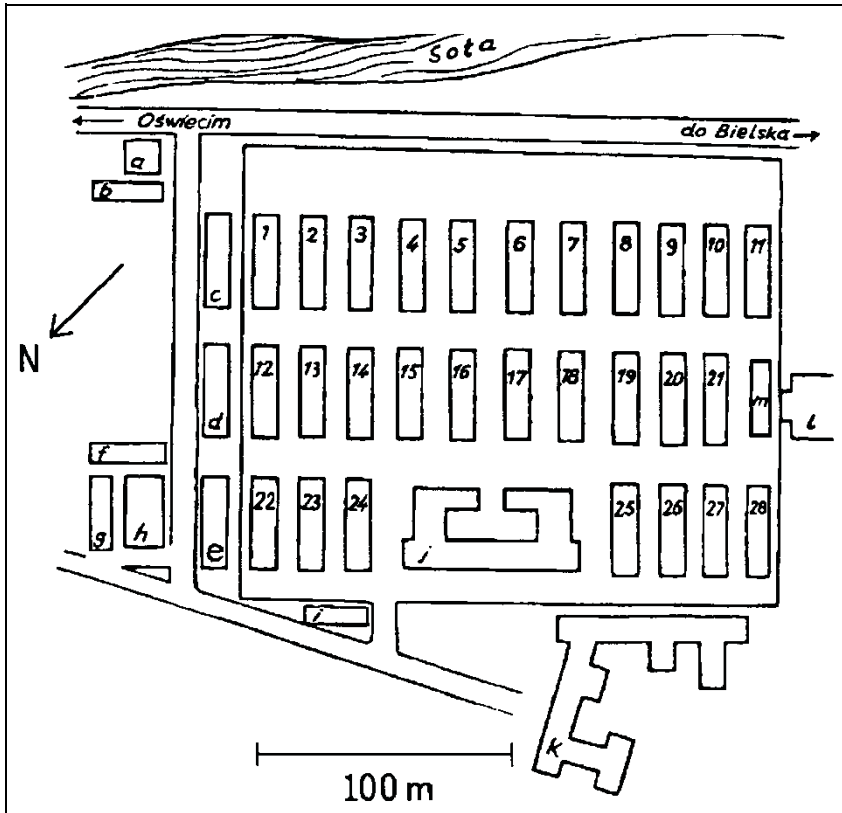

Fig. 11: Map of Auschwitz I/Main Camp (concentration camp), according to the information brochure of the Auschwitz State Museum in 1991.

Block 1 – 28: inmate barracks

- a: commandant's house
- b: main guard station
- c: camp commandant's office
- d: administration building
- e: SS hospital
- f, g: political division

- h: Crematorium I with "gas chamber"
- i: guard station near camp entrance gate (block leader room)
- j: camp kitchen
- k: inmate registration building
- l: camp warehouse, theatre building
- m: new laundry

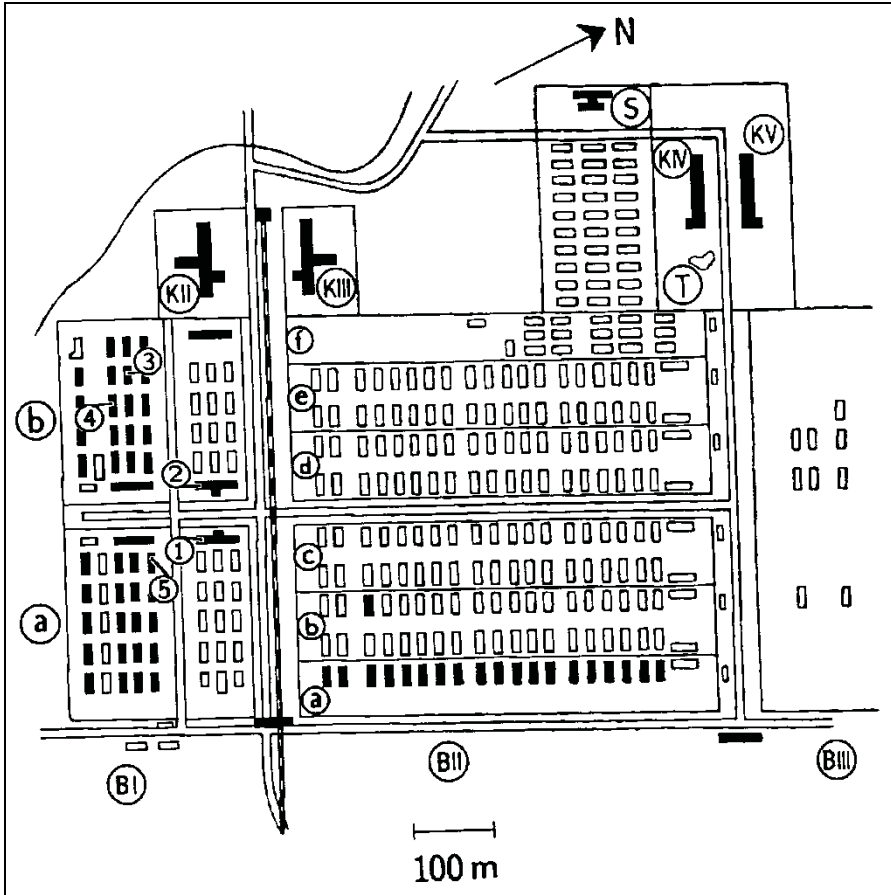

Fig. 12: Map of POW camp Auschwitz II/Birkenau, approximately 2 km north-west of the main camp, construction situation as of the end of 1944. The shaded buildings still exist, some of them, however, only in the form of ruins or foundations (Crematoria II-V), the rest having been torn down by Polish civilians for building materials after the war. According to the information brochure of the Auschwitz State Museum, 1991.

BI-III: building sector I to III

BIa/b: women's camp

BIla: quarantine camp

BIlb: family camp

BIlc: Hungarian camp

BId: men's camp

BIe: gypsy camp

BIf: inmate hospital

K II: Crematorium II with "gas chamber"

K III: Crematorium III with "gas chamber"

K IV: Crematorium IV with "gas chamber"

K V: Crematorium V with "gas chamber"

S: "Zentralsauna," hot-air/steam disinfestation

T: pond

1: building sector 5a – Zyklon B disinfestation

2: building sector 5b – Zyklon B disinfestation

3: inmate barracks no. 13

4: inmate barracks no. 20

5: inmate barracks no. 3

5.2. Epidemics and the Defense Against Them

5.2.1. Danger of Epidemics¹⁰²

Before the era of modern warfare, it has always been taken for granted that during a war epidemic disease caused more deaths among the soldiers and civilians than the use of weapons. It took the atomic bomb, deployed in a ruthless and criminal manner by the United States against unarmed people (whose government had already agreed to surrender) and in contravention to international law, to change this assumption.

The epidemic most feared in World War I at the eastern front was typhus.¹⁰³ Typhus epidemics claimed uncounted thousands of lives among German soldiers at the Russian front and could be prevented from spreading into German territory after the end of the war only by the most rigorous of measures. Since that time, the danger of epidemics has been taken seriously by medical and military offices and personnel.¹⁰⁴

For example, the German encyclopedia *Der große Brockhaus*, vol. VI of the 1930 Leipzig edition, contains a comprehensive article on epidemic typhus. This acute infectious disease is spread only by the body louse:¹⁰⁵

“The disease is caused by Rickettsia prowazeki (discovered in 1910 by Ricketts and in 1913 by Prowazek), a micro-organism found in the intestines and salivary glands of infected lice. [...]

Epidemic typhus occurs chiefly where unfavorable social and sanitary conditions prevail: in dank overcrowded living quarters, hospitals, prisons, emigration ships, caused by crop failures and price increases, thus also known as starvation, hospital, prison, ship or war typhus. Typhus is endemic in Russia, the Balkans, northern Africa, Asia Minor, and Mexico. According to Tarrassevich, 25-30 million people suffered from epidemic ty-

¹⁰² The following remarks are largely based on H.J. Nowak’s study, “Shortwave Delousing Facilities in Auschwitz,” in: G. Rudolf (ed.), *op. cit.* (note 24), pp. 312-324.

¹⁰³ Epidemic Typhus, which is also called European, Classic, or Louse-Borne Typhus, or Jail Fever, is a louse-borne disease caused by bacteria belonging to the Rickettsia group (*R. prowazekii*). Whereas Typhus is the term commonly used in English to refer to all diseases caused by various Rickettsia bacteria, the German term for Epidemic Typhus is “Fleckfieber.” This German term’s literal translation into English – “Spotted Fever” – is used only for one type of typhus, the so-called Rocky Mountain Spotted Fever (*R. rickettsii*) which is transferred by ticks (although there are other tick-transmitted bacteria of the same family); see www.merck.com/mmpe/sec14/ch177/ch177a.html.

¹⁰⁴ O. von Schjerning, *Handbuch der Ärztlichen Erfahrungen im Weltkrieg 1914/1918*, volume VII Hygiene, J. A. Barth Verlag, Leipzig 1922, in particular, pp. 266ff: “Sanierungsanstalten an der Reichsgrenze.”

¹⁰⁵ The *Brockhaus* Encyclopedia refers to the article by A. Schittenhelm, “Flecktyphus” in *Handbuch der Inneren Medizin*, 2nd ed., 1925.

phus in Russia in 1918-1921, which amounts to 20-23% of the population. [...]

Successful control and prevention of epidemic typhus consists of enforcing all measures available to destroy the body louse.”

The experiences of German physicians during WWII were no different.^{106,107} The topic of epidemics can be found in countless publications. Practical experiments were also conducted, which increased knowledge about fighting the causes of this disease.

Professor Dr. F. Konrich was completely justified in stating, in his publication “About sanitation facilities of German POW camps,”¹⁰⁸ that epidemics such as those in question “[...] had long been extinct here [in Germany].” However, it also becomes quite understandable why all of the offices and institutions involved over-reacted when epidemic typhus broke out in the Auschwitz concentration camp in early July 1942.¹⁰⁹ The outbreak was traced to the civilian laborers brought in to work in the camp, rather than to inmates deported to Auschwitz. Also, due to drastic measures taken to isolate and eradicate this epidemic, its spreading to the camp’s nearby civilian population could be prevented. Tragically, however, the epidemic inside the camp itself was brought under control only in the second half of 1943, hence it raged there for an entire year.

5.2.2. Epidemic Control with Zyklon B

One of the most efficient methods to fight lice and thereby to contain and eliminate typhus – but also to kill other vermin like grain beetles, bugs, cockroaches, termites, mice, rats and many more – is their poisoning with highly volatile hydrogen cyanide.

Liquid hydrogen cyanide has a short shelf life and is extremely dangerous when handled incorrectly. At the end of the First World War, hydrogen cyanide was introduced onto the market in an easier to handle and safer form: porous materials soaked with hydrogen cyanide with the addition of a stabilizer and an irritant warning material, intended to warn people of low concentrations of hydrogen cyanide, which in lower

¹⁰⁶ R. Wohlrab, “Flecktyphusbekämpfung im Generalgouvernement,” *Münchener Medizinische Wochenschrift*, 89(22) (1942), pp. 483-488.

¹⁰⁷ W. Hagen, “Krieg, Hunger und Pestilenz in Warschau 1939-1943,” *Gesundheitswesen und Desinfektion*, 65(8) (1973), pp. 115-127; *ibid.*, 65(9) (1973), pp. 129-143.

¹⁰⁸ Friedrich Konrich, “Über die Sanierungsanstalten der deutschen Kriegsgefangenenlager,” *Gesundheits-Ingenieur*, July 19, 1941, pp. 399-404.

¹⁰⁹ Cf. Wilhelm Stromberger, “Was war die ‘Sonderbehandlung’ in Auschwitz?,” *Deutschland in Geschichte und Gegenwart*, 44(2) (1996), pp. 24f.

concentrations has only a slight odor that many people cannot even smell at all.

This product, called Zyklon B, was then packed in tin cans, which can only be opened with a special tool. The number of patents filed for the additives to Zyklon B shows that there was no simple, clear solution to the problems relating to the stabilizers and irritant warning materials.

Legally, there was a great difference between the stabilizer for Zyklon B and the irritant warning material. A stabilizer for Zyklon B was required by German law,¹¹¹ while an irritant warning material, by contrast, was not legally required.¹¹²

Zyklon B was licensed and produced by the Degesch corporation residing in Frankfurt.¹¹³ Until the end of the Second World War, it played



Fig. 13: “We are blocking the entry of destructive insects.” Ad by the Degesch depicting its railway disinfection tunnels in Germany.¹¹⁰

¹¹⁰ *Anzeiger für Schädlingskunde*, 1939, cover; cf. F.P. Berg, “NAZI Railroad Delousing Tunnels for Public Health, or Mass Murder!,” www.nazigassings.com/Railroad.html.

¹¹¹ Deutsche Reichsbahn Eisenbahnverkehrsordnung (EVO, German Reich railway regulations), annex C to §54 EVO, *Vorschriften über die nur bedingt zur Beförderung zugelassenen Gegenstände vom 1. Okt. 1938* (Regulations on Objects Permissible for Restricted Transport Only, dated 1 October 1938), p. 50:

“Die Blausäure muß durch einen von der Chemisch-Technischen Reichsanstalt nach Art und Menge anerkannten Zusatz, der zugleich ein Warnstoff sein kann, beständig gemacht sein.” (The hydrogen cyanide must be stabilized by an additive, which may also be an irritant, in the manner and quantity recognized by the Chemical-Technical Reichs Foundation.)

¹¹² L. Gaßner, “Die gesetzlichen Bestimmungen der Anwendung hochgiftiger gasförmiger Stoffe zur Schädlingsbekämpfung in Deutschland” (The legal provisions relating to the use of highly poisonous gaseous materials for pest control in Germany), in: Karl Greimer, *Handbuch des praktischen Desinfektors*, Th. Steinkopf, Dresden 1937, pp. 185f. The fact that Auschwitz concentration camp received Zyklon B without an irritant is therefore not so unusual as sometimes represented in the literature, i.e., as a “criminal trace.” The well-known “exceptional” regulations for the Waffen SS are no exception; they merely referred to the applicable Reichs regulations and implementation provisions regulating the use of Zyklon B; see Deutsches Reich, “Anwendung von hochgiftigen Stoffen zur Schädlingsbekämpfung durch die Waffen-SS,” Rund-Erlaß des Reichsministers für Ernährung und Landwirtschaft vom April 3, 1941, quoted acc. to *Zeitschrift für hygienische Zoologie und Schädlingsbekämpfung*, 33 (1941), p. 126.

¹¹³ On the history of the firm, mixed with uncritical Holocaust story telling, see Jürgen Kalthoff, Martin Werber, *Die Händler des Zyklon B*, VSA-Verlag, Hamburg 1998.

an extraordinarily important role in the struggle against insect pests and rodents^{114,115} in food warehouses, large-scale means of transport like trains and ships, both in Europe and in America.¹¹⁶ For example, Dr. G. Peters reports in his work *Blausäure zur Schädlingsbekämpfung* (Hydrogen Cyanide for Pest Control)¹¹⁷ about the fumigation of ships with hydrogen cyanide, which happened in the United States as early as 1910, and about tunnel facilities, into which entire railway trains could be driven in order to be disinfested (see Fig. 13 & 14). The use of Zyklon B in public buildings, barracks, PoW and concentration camps was also featured in the literature of that time.¹¹⁸⁻¹²¹ Of course, there were several other gaseous pest control agents in addition to Zyklon B.^{122,123} Zyklon B continued to play an important role even after the war, until it was largely replaced by DDT and its successors.^{124,125}

A large number of publications are available from both the wartime and pre-war periods, to which reference is made.^{117,118,121,126-130} There

¹¹⁴ O. Hecht, "Blausäuredurchgasungen zur Schädlingsbekämpfung," *Die Naturwissenschaften*, 16(2) (1928), pp. 17-23.

¹¹⁵ Gerhard Peters, W. Ganter, "Zur Frage der Abtötung des Kornkäfers mit Blausäure," *Zeitschrift für angewandte Entomologie*, 21(4) (1935), pp. 547-559.

¹¹⁶ Gerhard Peters, "Eine moderne Eisenbahn-Entwesungsanlage," *Anzeiger für Schädlingskunde*, 14(8) (1938) pp. 98f.; cf. F.P. Berg, "Typhus and the Jews," *JHR*, 8(4) (1988), pp. 433-481.

¹¹⁷ Gerhard Peters, *Blausäure zur Schädlingsbekämpfung*, Ferdinand Enke Verlag, Stuttgart 1933.

¹¹⁸ Walter Dötzer, "Entkeimung, Entseuchung und Entwesung," in: J. Mrugowsky (ed.), *Arbeitsanweisungen für Klinik und Laboratorium des Hygiene-Instituts der Waffen-SS*, 2nd ed., Urban & Schwarzenberg, Berlin and Vienna 1943.

¹¹⁹ F.E. Haag, *Lagerhygiene, Taschenbuch des Truppenarztes*, vol. VI, F. Lehmanns Verlag, Munich 1943.

¹²⁰ F. Puntigam, "Die Durchgangslager der Arbeitseinsatzverwaltung als Einrichtungen der Gesundheitsvorsorge," *Gesundheits-Ingenieur*, 67(2) (1944), pp. 47-56.

¹²¹ For a more recent treatment of the topic, see: F.P. Berg, *op. cit.* (note. 116).

¹²² G. Peters, *Die hochwirksamen Gase und Dämpfe in der Schädlingsbekämpfung*, F. Enke Verlag, Stuttgart 1942.

¹²³ Degesch, *Acht Vorträge aus dem Arbeitsgebiet der Degesch*, 1942, p. 47; Document NI-9098 from the Nuremberg Trials, table of properties of the gaseous insecticide/pest control product used by Degesch.

¹²⁴ H. Kruse, *Leitfaden für die Ausbildung in der Desinfektion und Schädlingsbekämpfung*, Muster-Schmidt, Göttingen 1948.

¹²⁵ H. Kliewe, *Leitfaden der Entseuchung und Entwesung*, F. Enke Verlag, Stuttgart 1951.

¹²⁶ F. Puntigam, H. Breymesser, E. Bernfus, *Blausäuregaskammern zur Fleckfieberabwehr*, Sonderveröffentlichung des Reichsarbeitsblattes, Berlin 1943.

¹²⁷ G. Peters, "Gefahrlose Anwendung der hochgiftigen Blausäure in Entlausungskammern," *Arbeitsschutz*, 5(III) (1942), pp. 167f.

¹²⁸ F. Puntigam, "Raumlösungen von Entlausungsanlagen," *Gesundheits-Ingenieur*, 67(6) (1944), pp. 139-180.

¹²⁹ E. Wüstinger, "Vermehrter Einsatz von Blausäure-Entlausungskammern," *Gesundheits-Ingenieur*, 67(7) (1944), p. 179.

¹³⁰ A more recent summary of this topic was prepared by Friedrich P. Berg, "The German Delousing Chambers," *JHR*, 7(1) (1986), pp. 73-94; cf. also F.P. Berg, "Typhus and the Jews," *JHR*, 8(4) (1988), pp. 433-481.

are also guidelines on the fumigation of property and rooms, describing the procedures in detail, both before and afterwards.^{131,132} These do not considerably differ from the regulations in application today.¹³³ Based upon this, the following is a brief discussion of the technology and method of procedure employed.

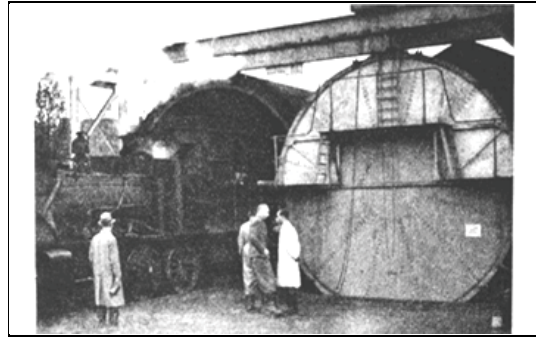

Fig. 14: A lice-ridden train enters a railway gassing tunnel in Budapest.¹¹⁶

Initially, for the disinfection of personal effects, ordinary rooms (10 to 30 m² surface area) were temporarily modified, by making the windows and doors as gas-tight as possible by means of felt sealant material and paper strips, while providing for proper heating and ventilation of the rooms. Workers wearing gas masks spread Zyklon B evenly on the floor of the room containing the property to be disinfested. This procedure was similar to what was then the regular fumigation of ordinary rooms for the destruction of vermin. Such converted rooms may be seen even today in the main camp of Auschwitz I. The use of temporarily sealed rooms for fumigation purposes is not without risk since the sealing is never perfect.

Later, special gas-tight installations without windows were built, equipped with efficient heating and ventilation systems, and later also with circulating air systems for a more rapid circulation of the gas inside the room (so-called “*Degesch-Kreislaufverfahren*,” Degesch circulation procedure, see Fig. 15, p. 59). Cans of Zyklon B were opened by means of an exterior mechanism, so that the workers were no longer exposed to danger. The bottom of the can was automatically punctured and the preparation fell into a basket, into which a fan blew hot air, thus quickly evaporating the hydrogen cyanide and carrying the fumes away. These Degesch circulation devices were relatively small in size, a few m³, to economize on the expensive disinfestant.

¹³¹ *Entseuchungs- und Entwesungsvorschrift für die Wehrmacht*, H. Dv. 194, M. Dv. Nr. 277, L. Dv. 416, Reichsdruckerei, Berlin 1939.

¹³² *Richtlinien für die Anwendung von Blausäure (Zyklon) zur Ungezieferverteilung (Entwesung)*, Gesundheitsanstalt des Protektorats Böhmen und Mähren, Prag o.J.; Dokument NI-9912(1) at the International Military Tribunal, reproduced in G. Rudolf (ed.), *op. cit.* (note 47), pp. 94-99.

¹³³ *Technische Regeln für Gefahrstoffe*, TRGS 512, Begasungen, BArbBl. no. 10/1989, p. 72, in: Robert Kühn, Karl Birett, *Merklblätter Gefährlicher Arbeitsstoffe*, ecomed, Landsberg 1990.

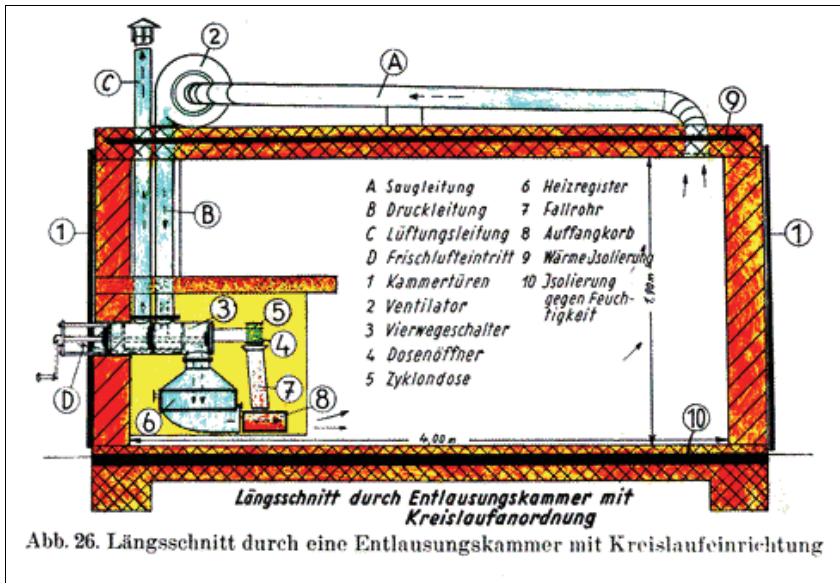

Fig. 15: Degesch delousing chamber with circulation feature.¹³⁴

These professional installations were often part of an entire hygienic complex. As a rule, such a building complex was organized approximately as follows in terms of purpose (see Fig. 16, p. 60):¹⁰⁸

- Undressing room, “dirty side.” People to be deloused removed their soiled clothing and handed them over for laundry/disinfestation/disinfection.
- Shower. Prisoners washed themselves after undressing, plus sometimes other procedures, such as haircuts, medical examinations, or at times even including a sauna.
- Dressing room, “clean side.” Their own cleaned and sanitized clothing was given back to the prisoners or substitute clothing was issued to them, since the cleaning may have lasted many hours.
- Disinfestation/Disinfection room. An area to clean and process the clothing combined with a laundry.

It was not uncommon for a crematorium to be installed in the same building complex, as may still be seen at Dachau concentration camp today (near Munich), in which the new hygienic installation possesses a series of Degesch circulating air installations for the disinfestation of clothing, with an undressing and redressing room to the right and left of the inmate showers, as well as a crematorium. (The room described as a

¹³⁴ Ludwig Gaßner, “Verkehrshygiene und Schädlingsbekämpfung,” *Gesundheits-Ingenieur*, 66(15) (1943), pp. 174ff.; cf. F.P. Berg, *op. cit.* (note. 116).

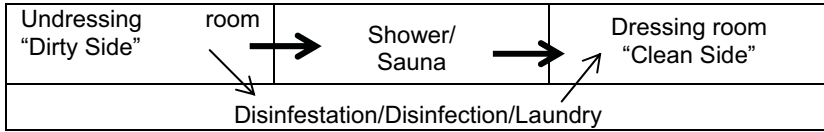

Fig. 16: Schematic organization of a hygiene complex
 → Clothing pathway; → Inmate pathway

“gas chamber” at Dachau today is actually the inmate shower, which is indispensable in the above schema, and which has been intentionally mislabeled by the museum.)

The applicable concentrations during the disinfestation of clothing might be very different according to the type of vermin and exterior conditions, and usually ranged from 5 to 30 g of hydrogen cyanide per m³ of air. The application time varied just as greatly, from under two hours up to ten hours and more. In the more modern installations with heating (higher than 25°C) and circulating air/ventilation installations, good results could be attained with concentrations of 20 g per m³ already after 1 to 2 hours. Disinfestation in ordinary rooms, on the other hand, could last up to 24 hours or more.

5.2.3. Epidemic Control in Auschwitz

5.2.3.1. Terminology Used and Responsibilities

We shall use the technical terms established in the 1939 German Army Regulations (*Heeresdienstvorschrift* 194),¹³¹ since these determined how the personnel, *i.e.*, the physicians and those who disinfested the camps, were to proceed:

“Disinfection

Disinfection means [...]: destroying the disease-(epidemic-)causing agents on objects, in rooms, in excretions and on the bodies of infectious persons.

Disinfestation

Disinfestation means: ridding rooms, objects and people of vermin (small life forms) that can transmit pathogens, cause economic damage or annoy man.”

The regulation quoted lists all known physical and chemical means of disinfection and disinfestation. Similarly, a “work guideline” was released in 1943 by the Sanitation Institute of the Waffen-SS: “*Entkeimung, Entseuchung und Entwesung*”¹¹⁸ (Sterilization, Disinfection and Disinfestation).

Für alle Zwecke
der Schädlingsbekämpfung in Gebäuden, geschlossenen Räumen und Gaskammern werden unsere hochwirksamen Gasverfahren bevorzugt:
Zyklon, Cartox, T-Gas und Tritox

Degesch

DEUTSCHE GESELLSCHAFT FÜR SCHÄDLINGSBEKÄMPFUNG. M. B. H. FRANKFURT A. M.

Fig. 17: Typical advertisement of the firm Degesch about the broad variety of applications of gassing methods offered: Flour mills, ships, stores, grain storages, houses, railroad cars, trucks.¹³⁵

The authority in charge of sanitation in the Waffen-SS as well as in the concentration camps was the “Hygieneinstitut der Waffen-SS”¹³⁶ (Sanitation Institute of the Waffen-SS), established in 1942 in Berlin, which set up a branch office in Rajsko near Auschwitz with its “Hygienisch-bakteriologischen Untersuchungsstelle Südost d. W-SS” (Sanitary and Bacteriological Testing Station Southeast of Waffen-SS). The files from this testing station have survived (151 volumes dating from 1943 to 1945).¹³⁷

The garrison physician (army medical officer) and the medical personnel were in charge of implementing all sanitary measures. This physician – and this was the case at Auschwitz as well – was to be consulted as subject expert in all relevant matters of construction planning and other things. Where hydrogen cyanide was to be used, requirements called for specially trained expert personnel. In Auschwitz, this role was filled by the “disinfectors.”

¹³⁵ *Der praktische Desinfektor*, no. 2, Verlag Erich Deleiter, Berlin 1941, inside cover; cf. F.P. Berg, *op. cit.* (note. 116).

¹³⁶ RGVA 502-1-26-117.

¹³⁷ Heinz Bobrach *et al.*, *Inventar archivalischer Quellen des NS-Staates*, K. G. Saur, Munich 1995, volumes 3/1, 1991. So far, we are aware of approximately 110,000 laboratory examinations. Many probative and highly informative facsimiles are to be found in *Hefte von Auschwitz*, nos. 1 through 19, special editions, Auschwitz State Museum Publishers, Auschwitz Museum, since 1959.

5.2.3.2. Procedures Used

Generally, four procedures were used at Auschwitz for disinfestation and disinfection:

- hot air
- hot steam
- hydrogen cyanide
- microwaves

Data on the disinfestation and disinfection installations in operation in Auschwitz camp may be taken from a listing dated January 9, 1943: “*Hygienische Einrichtungen im KL und KGL Auschwitz*”¹³⁸ (Sanitary Facilities in the POW and Concentration Camp Auschwitz) directed to the *Amtsgruppenchef C* (Berlin), and an “*Aufstellung über die im KL und KGL. Auschwitz eingebauten Entwesungsanlagen Bäder und Desinfektionsapparate*”¹³⁹ (List of Disinfestation Facilities, Baths and Disinfection Systems Installed in the POW and Concentration Camp Auschwitz), dated July 30, 1943.

The following capacities, taken from the last-mentioned document, relate to a 24-hours-a-day operation period.

a) In the concentration camp (protective custody camp):

Block 1: One hot air disinfestation installation, manufactured by the Klein corporation for 1,800 people and approximately 3,600 blankets since the fall of 1940.

Block 3: One hydrogen cyanide gas disinfestation installation (*i.e.*, Zyklon B), for 1,400 people and approximately 20,000 pieces of laundry.¹⁴⁰

Block 26: One hot air installation for 2,000 people.

Disinfestation building at *Deutsche Ausüstungs-Werke* (German Equipment Works, *i.e.*, Canada I): 1 hydrogen cyanide gas disinfestation installation (BW 28) for approximately 30,000 pieces of laundry, blankets, etc. (in operation since the summer of 1942).

Civilian worker disinfestation barracks: One hot air disinfestation installation, manufactured by the *Hochheim* corporation, with a daily capacity for 2,000 people, with large shower bath installation and disinfection apparatus, permanently installed.

b) In the POW camp (K.G.L., Birkenau):

¹³⁸ RGVA 502-1-332-46/46a.

¹³⁹ RGVA 502-1-332-9/10.

¹⁴⁰ According to Pressac, in operation since 1941/42, *op. cit.* (note 72), p. 25.

BW 5a in B Ia: One disinfestation apparatus (manufactured by *Werner*) and one hot air apparatus (manufactured by *Hochheim*) in operation since November 1942 for 2, 000 people.

One chamber for hydrogen cyanide fumigation has been built for 8,000 blankets and has been in operation since the fall of 1942.

BW 5b in B Ib: Installation as in BW 5a.

All the facilities listed therein were subject to modifications. The number of sanitary facilities increased with the number of inmates, as the two aforementioned documents already show. Pressac mentions 25 chambers operated with Zyklon B, without providing a verifiable source.¹⁴¹

5.2.3.3. Results

The results could only be compiled if one knew the number of persons disinfested by means of the installation. These numbers have thus far remained unclear. Although Danuta Czech claims in her book⁹⁴ that such documents on large time periods are available in the Auschwitz archive, we have so far been unable to examine them. As of the present writing, it is still impossible to make a reliable statement as to whether or not the existing disinfestation installations were consistently reliable for the indicated number of persons. Pressac, in the conclusions to his second book,¹⁴² indicates the peak of the first epidemic between “September 7-11” 1942 with “375 deaths per day,” which clearly indicates that the capacity of the facilities available did not suffice.

5.2.3.4. Basic Policy Decisions

Two policy decisions made by the *SS-Hauptamt Haushalt und Bauten* (SS Main Office Budget and Construction) in the Reich Administration of the SS and its successor no doubt also influenced the measures taken in the camp. The first decision of June 5, 1940,¹⁴³ stated that HCN would no longer be used, and replaced instead with a hot-air method. The reason for this was probably that the use of HCN in makeshift delousing chambers was not reliable and had caused many accidents and was thus deemed too dangerous. The second decision, issued on March

¹⁴¹ *Ibid.*, p. 550.

¹⁴² J.-C. Pressac, *op. cit.* (note 95), p. 157

¹⁴³ *RGVA* 502-1-333-145

11, 1942,¹⁴⁴ 21 months later, seems to have reversed that first decision by calling for the “[...] conversion of all delousing facilities to operation with HCN,” in which regard it was noted:

“Deviations therefrom – delousing by means of hot air or hot steam – are only permissible insofar as they involve temporary installations, in which the necessary safety for the handling of HCN is not ensured.”

A further letter from the Office C VI of February 11, 1943,¹⁴⁵ to the Commandant again expressly states, probably with reference to the letter of June 5, 1940: “[...] as per the prohibition against the use of HCN for disinfestation [...].” This means that all efforts were to be made to convert all facilities to be operated with the only really reliable method available – HCN – but that the use of HCN was allowed only where and if the necessary safety and reliability of the method was ensured, *i.e.*, makeshift delousing chambers were not allowed to be operated with HCN.

Men in positions of authority, accustomed to decision-making, and faced with a dangerous epidemic capable of spreading to the civilian population with incalculable consequences, will always take suitable measures and act accordingly. Hydrogen cyanide (= Zyklon B) was the most reliable disinfestation agent of its time^{146,147} The only problem was in finding a safe location for such facilities, perhaps outside the actual camp (see chapter 5.4.3.).

5.2.3.5. The Army Medical Officer

On September 9, 1942, Dr. E. Wirths was stationed in Auschwitz as garrison physician. From the records we may say that he performed his duties correctly; in this context, reference is made in particular to his massive criticism of the highest echelons.

As time went by, the number of inmates increased steadily, and unfortunately there were more than just one epidemic. We shall therefore briefly summarize, by means of examples, the conclusions reached by this physician and the steps he took in consequence.

On December 4, 1942, Dr. Wirths reported to headquarters about a discussion held in the administrative council of Bielitz District. The

¹⁴⁴ RGVA 502-1-336-94

¹⁴⁵ RGVA 502-1-332-37

¹⁴⁶ Gerhard Peters and W. Rasch, “Die Blausäure als Entlausungsmittel in Begasungskammern,” *Der praktische Desinfektor*, September 1941, pp. 93-96.

¹⁴⁷ Gerhard Peters, Emit Wüstinger, “Entlausung mit Zyklon-Blausäure in Kreislauf-Begasungskammern. Sach-Entlausung in Blausäure-Kammern,” *Zeitschrift für hygienische Zoologie und Schädlingsbekämpfung*, issue 10/11 (1940), special printing. RGVA 502-1-332-86/90; it arrived at the Auschwitz construction office on July 3, 1941.

subject was epidemic typhus. A considerable number and range of persons had participated in the discussion, including the medical officer, the Wehrmacht, and representatives of the government. This illustrates how seriously the epidemic was taken:¹⁴⁸

“He reports that at present three large disinfestation, shower, and sauna facilities could be put into operation, specifically two facilities for the inmates and one for the members of the SS troops. The capacity of these facilities is some 3,000 to 4,000 persons per 24 hours. Zyklon B disinfestation has been discontinued entirely, since it has been found that success is not 100% certain with this procedure.”

Buildings BW5a and 5b were intended for the inmates. The capacity of these disinfestation facilities was probably adequate for the number of inmates at this time. One must consider, however, that at this same time the structural shell for another 19 Degesch circulation fumigation chambers was being completed in Building BW160 of the Main Camp (admissions building). Another paragraph of the above letter states that the garrison physician of Kattowitz had provided the loan of two mobile boiler installations.

On April 18, 1943, Wirths reports to the Commandant, with warning reference to the sewer system in Birkenau, and concludes that “[...] great danger of epidemics is inevitable.”¹⁴⁹

On May 7, 1943, in a discussion with the chief of Amtsgruppe C, SS Brigadier General and Major General of the Waffen-SS engineer Dr. Kammler and others, the garrison physician set out in chapter “II. Bauten in Zuständigkeit des Standortarztes” (II. Buildings Under the Charge of the Garrison Physician):¹⁵⁰

“[...] that the continued health of the inmates for the major tasks is not guaranteed, due to the poor toilet conditions, an inadequate sewer system, the lack of hospital barracks and separate latrines for the sick, and the lack of washing, bathing, and disinfestation facilities.”

Dr. Wirths clearly pointed out the inadequacies and also how to rectify them.

At this point we must warn the reader, who may perhaps not be sufficiently aware of the historical context, not to jump to false conclusions. The reader may well lack an understanding of all the problems that were involved in obtaining materials as well as all the other necessities required to build these facilities in wartime. Figuratively speaking, a written permission was required to purchase every brick.

¹⁴⁸ RGVA 502-1-332-117/119

¹⁴⁹ RGVA 502-1-332-219

¹⁵⁰ RGVA 502-1-233-33/38

We must also point out that, in those days in eastern Europe, a sewer system of any kind at all was exceptional to start with, and that this is all the more true for sewage treatment facilities, which were built for both camps at great expenditure in resources and according to high technical standards.

The above quoted document continues:

“The Brigadier General acknowledges the foremost urgency of these matters and promises to do everything possible to ensure rectification of the shortcomings. He is somewhat surprised, however, that the medical side presents him with reports giving a very favorable account of the sanitary and hygienic conditions on the one hand; while he is then immediately confronted with reports to the exact opposite effect on the other hand. The Chief of the Central Construction Office is hereby instructed to present suggestions for rectification by May 15, 1943.” (Emphasis added.)

It began with the toilet facilities, with regards to which he enforced changes that he considered necessary. For example: lids on the toilets, because otherwise “[...] a great danger of epidemics is inevitable.”¹⁵¹ These lids were ordered by the Head of Department C of the WVHA (*Wirtschafts-Verwaltungshauptamt*, Economic Administrative Main Office) on May 10, 1943.¹⁵² It ended with roofing matters related to the gypsy kindergarten.¹⁵³

“For the damaged roofs of kindergarten blocks 29 and 31 in the Gypsy Camp I request 100 rolls of roofing felt (very urgent.)”

In between, on May 28, 1943,¹⁵⁴ he selected six circulating air de-lousing facilities which – as was noted down in handwriting – were ordered on May 29, 1943, by the Building Administration’s expert on heating matters, Jährling. Then there is an account of a water quality test on June 1, 1943,¹⁵⁵ etc. This extensive correspondence resulted in separate subject files in the filing system of the Central Construction Office, such as “Sanitary Conditions.”¹⁵⁶

The physician’s field of work was great and varied and deserved its own monograph. He was even responsible for ensuring that the inmates’ kitchen personnel were frequently examined – including laboratory tests of their stool, etc. That Dr. Wirths truly saw to absolutely everything, is obvious from the documents.

¹⁵¹ RGVA 502-1-322-219

¹⁵² RGVA 502-1-322-31

¹⁵³ Taken from a letter of March 23, 1944 to the Zentralbauleitung (Central Construction Office) in Auschwitz, RGVA 502-1-332-175.

¹⁵⁴ RGVA 502-1-332-28

¹⁵⁵ RGVA 502-1-332-212

¹⁵⁶ RGVA 502-1-149-135

The garrison physician's reminders and admonitions increased over time. On balance, one must conclude that, just as today, while there were opportunists and careerists in those days, there were also – as our example shows – SS-men with backbone and a sense of duty, professional ethics and the courage to stand up for their beliefs.

At the end of the comments section of the Memorandum of May 9, 1943, we find:

“As stop-gap measure until that time, the Brigadier General provides the loan of a new short-wave delousing platoon.” (Emph. added.)

5.2.3.6. Short-Wave Delousing Facility

Perhaps one of the most fascinating aspects of Auschwitz concentration camp is the installation of a stationary short-wave installation, the world's first technological predecessor to the microwave ovens in common use today. This technology was invented by Siemens in the late 1930s and developed to mass-production readiness during the war. This was a by-product of the powerful radio tubes built for the television transmission of the Berlin Olympics in 1936, the energy-rich radio waves of which killed the insects in the vicinity of the antenna. The development took place with financial assistance from the Wehrmacht, which hoped to achieve a perceptible improvement in the struggle against the epidemics raging in the east. Since the inmates assigned to the armaments industries in the concentration camps were particularly valuable towards the end of the war, the Reich leadership decided not to put the first installation into operation at the eastern front for the disinfection of soldiers' clothing, but rather, in the largest labor complex in the Reich, in Auschwitz. Due to Allied bombing attacks, however, there was a one-year delay in the completion of this installation, which probably cost the lives of tens of thousands of inmates. The Auschwitz camp administration had anticipated its installation as early as 1943 and had therefore postponed other delousing projects. This facility, put into operation during the summer of 1944, proved in fact to be of revolutionary effectiveness, both quick and cheap: personal effects were moistened and placed on one end of a conveyor belt and emerged at the other end a few minutes later, completely free of vermin and sterile.¹⁵⁷

¹⁵⁷ See also, in this regard, H.J. Nowak, *op. cit.* (note 102); H. Lamker, “Die Kurzwellen-Entlausungsanlagen in Auschwitz, Teil 2,” *VffG* 2(4) (1998), pp. 261-272 (<http://www.vffg.de/1998/4/Lamker4.html>); for an English summary see “High Frequency Delousing Facilities at Auschwitz,” *JHR*, 18(3) (1999), p. 4.

5.2.4. Disinfestation Installations BW 5a und 5b

The only structures remaining intact in Auschwitz-Birkenau today, possessing a wing for the disinfestation of personal effects with Zyklon B, are buildings (*Bauwerk*, BW) 5a and 5b in construction sections B1a and B1b, respectively. Both buildings were planned as mirror images of each other. The west (respectively east) wing of these buildings were used, at least temporarily, for disinfestation with Zyklon B. These rooms were expressly labeled “*Gaskammer*” (gas chamber) in the building plans, see Fig. 18.

This is no triviality: rather, it is important proof that the term “gas chamber,” at that time, referred exclusively to installations for the disinfestation of personal effects, both by architects during the planning of such buildings, and by disinfestation experts. The title of one of the most important contemporary publications on the subject of cyanide disinfestation by F. Puntigam, H. Breymesser, E. Bernfus was, for example, *Blausäuregaskammern* [sic] *zur Fleckfieberabwehr* [hydrogen cyanide **gas chambers** for the prevention of epidemic typhus], and the term used in an advertisement of the firm Degesch was likewise “**gas chambers**,” see Fig. 17, p. 61. This was simply the ordinary designa-

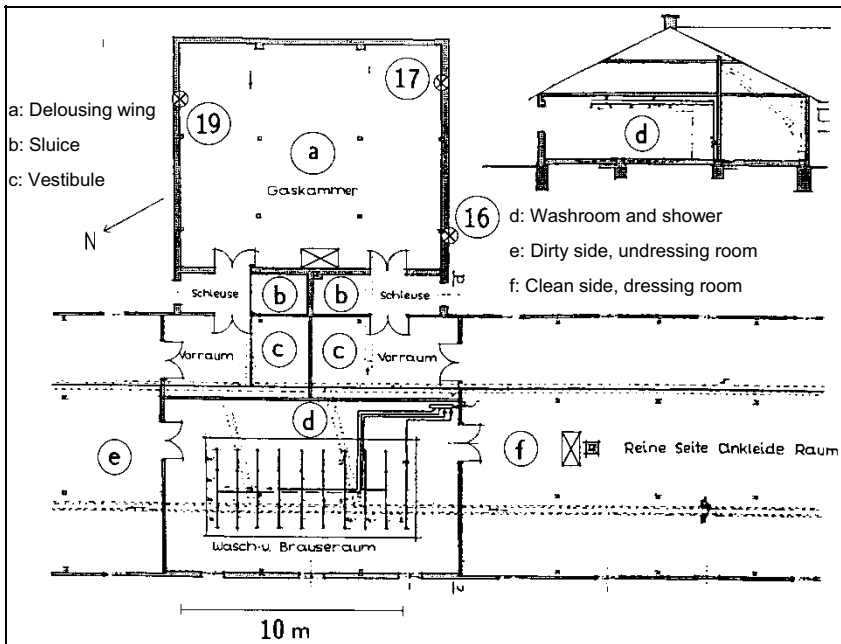

Fig. 18: Ground plan of the HCN disinfestation wing of building 5a before building alterations (mirror image) and BW 5b today. BW 5b sample taking locations drawn in.¹⁵⁸

tion for rooms used for the disinfestation of personal effects.

Therefore, we must always assume, in the absence of proof to the contrary, that the use of the term “gas chamber” in a German document from this period refers to a room for the disinfestation of personal effects!

For this reason, *in the following*, the term gas chamber will be placed in quotation marks at all times (“gas chamber”), whenever the word refers to chambers for the execution of human beings. There are two reasons for this:

1. The German technical term *Gaskammer* originally pointed exclusively to disinfestation chambers operated with toxic gas. To apply the same term to chambers intended for the execution of human beings is an incorrect use of the term at that time.
2. Simply for the purpose of avoiding confusion as to the meaning of the word “gas chamber” in each case, a distinction must be made in writing.

Fig. 18 shows the ground plan of the two disinfestation gas chambers of building 5a and 5b approximately in their original condition. The chamber in building 5a was transformed in the summer of 1943 and

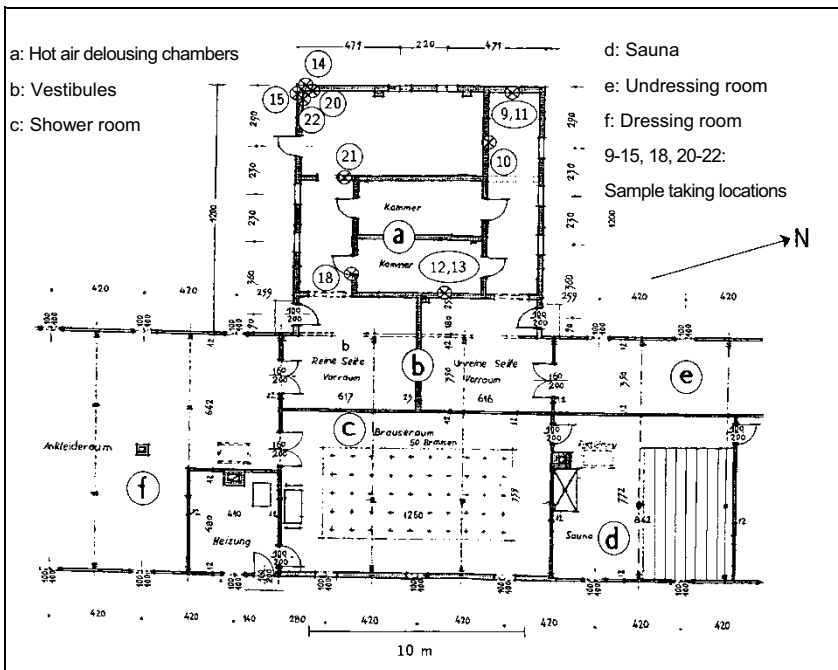

Fig. 19: Ground plan of the hot air disinfestation wing of building 5a after building alterations in 1943. BW 5a sample taking locations drawn in.¹⁵⁸

received two small hot air chambers, visible in Fig. 19.¹⁵⁸ The buildings have ordinary brick walls and a concrete foundation built level with the ground, plastered and whitewashed on the interior with chalk-based mortar. The room in building 5b has no separate ceiling, the roof's framework is covered from underneath with boards of an unknown material (perhaps Heraclite). Originally without windows, like building BW 5b today, the disinfestation wing of BW 5a was equipped, during the building alterations, with windows firmly walled in which cannot be opened.

In the gable wall of the disinfestation room in BW 5b are two circular openings, approximately 50 cm in diameter, corresponding to the former ventilation exhaust and air intake channels, Fig. 20. The roof has three ventilation chimneys; there must have been three ovens in this room during the time of operation.¹⁵⁹ The double doors, opening inwards and drawn onto the plans, have been replaced with single doors, also opening inwards. For the time being, one can only speculate on any equipment of the disinfestation chambers.

The room has a surface area of approximately 130 m², is open to the framework of the roof, and therefore has a volume of at least 400 m³.



Fig. 20: Ventilation outlets from the disinfestation wing of building BW 5b, without equipment today. The ends of the water pipes are visible inside; see also Fig. 21.

¹⁵⁸ J.-C. Pressac, *op. cit.* (note 72), pp. 55-58, Plans of buildings 5a/b, pp. 59f. exterior photos. Building alteration plan no. 2540 for conversion to hot air delousing installation, dated July 5, 1943.

¹⁵⁹ *Ibid.*, p. 53.

However, the space above 2 m in height must probably be considered to have been unusable dead space, resulting in the waste of huge amounts of HCN/Zyklon B, since a quantity of Zyklon B of at least 4 to 5 kg (10 g per m³) cyanide content was necessary for just one gassing,¹⁶⁰ regardless of whether the room contained only a few personal effects or whether the available area was filled. For example, with 100 fumigation cycles per year (one every 3 or 4 days) approximately 0.8 tons of Zyklon B would have been consumed by this installation alone and by building 5a, corresponding to 10% of the entire Zyklon B deliveries to Auschwitz in 1942, with a total delivery of 7.5 tons.¹⁶¹

When one considers that there were other HCN disinfestation installations in Birkenau in addition to this one; that the deliveries to Birkenau camp also supplied the related labor camps (more than 30 in number); and the fact that inmate barracks were also occasionally fumigated with this insecticide,¹⁶² it becomes clear that the quantities of Zyklon B delivered to Auschwitz camp can actually be explained by normal delousing activities.

The annual delivery quantities were evidently too low to ensure successful disinfestation of all personal effects and buildings in all camps in the Auschwitz complex, since typhus epidemics were never entirely eliminated.

How frequently the delousing chambers of BW 5a and 5b were actually used for HCN disinfestation has to remain open for the time being, since no documentation about this has been found yet, and also because the document cited above states that the use of Zyklon B had to be abandoned as early as December 1942 (at least in unsafe installations), *i.e.*, just a few weeks after this installation was put into operation (see p. 65).

¹⁶⁰ The gross mass given on the label of a Zyklon B can always refer to the net HCN content of the can, *i.e.*, excluding the mass of the carrier material. That means for instance that a 1 kg Zyklon B can consisted of 1 kg HCN *plus* some 2 kg of carrier material, *i.e.*, a 1 kg can had a total mass of some 3 kg.

¹⁶¹ Office of Chief of Counsel for War Crimes, British Military Tribunal, Case against B. Tesch *et al.*, here, the sworn statement of A. Zaun, Hamburg Oct. 24, 1945, Document No. NI-11 396; quoted according to U. Walendy, *Auschwitz im IG-Farben-Prozeß*, Verlag für Volkstum und Zeitgeschichtsforschung, Vlotho 1981, p. 62.

¹⁶² See also the Höß order relating to the avoidance of accidental poisoning during the disinfestation of barracks, reproduced by J.-C. Pressac, *op. cit.* (note 72), p. 201. For each barracks with a volume of approximately 40m×12m×3.5m > 1,500 m³, this means a requirement of 15 kg Zyklon B; the 100 barracks in Birkenau camp alone would require 1.5 tons!

A remarkable feature of the disinfestation room of building BW 5b is a network of the water pipes, laid in hooks fastened to the diagonal roof girders, visible in Fig. 21. A few of the pipe endings are equipped with shower heads. The water pipes have no connection. Paradoxically, they end in the above mentioned ventilation outlets, and can only have been installed after the removal of the ventilators installed there. There are, of course, shower rooms in these buildings, but in a very different location (see Fig. 18). The shower installations once in existence there, however, have been entirely dismantled. Since the doors to these rooms were open in the early 1990s, any visitor could examine this peculiar construction. The original German drawings and documents of this building do not indicate that these pipes were installed during the German occupation, which means that they were probably installed after the war for an unknown reason.

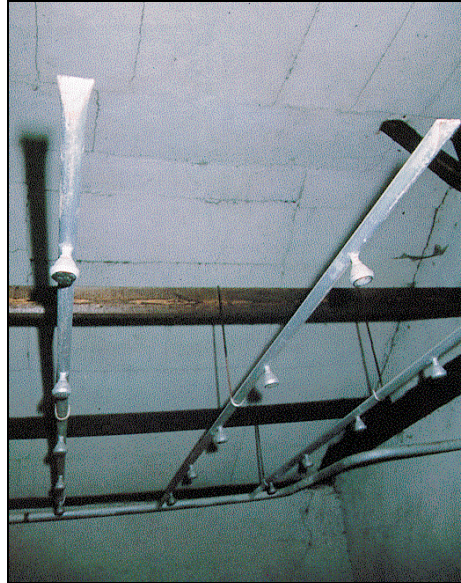

Fig. 21: Water pipe system with shower heads in the disinfestation wing of building BW 5b. These water pipes have no connection; they terminate in the ventilation outlets. See Fig. 20.

5.3. “Gas Chamber” in the Auschwitz I Main Camp

According to Pressac, no material or documentary evidence of the “gas chamber” in the crematorium in the main camp exists, but there are many eyewitness accounts:¹⁶³

“As evidence to establish the reality of homicidal gassings there remain only the testimonies of participants,[...]”

These accounts, according to Pressac, are characterized by many contradictions, technical impossibilities, and general incredibility. He observes a “general tendency to exaggerate,” and explains the gross

¹⁶³ J.-C. Pressac, *op. cit.* (note 72), p. 123.

errors and technical impossibilities in the eyewitness accounts and writings of camp commandant Höß by stating:

“He was present, without seeing.”

That is, Pressac alleges that Höß had no idea of the methods, risks and dangers involved in the handling of Zyklon B. But this is in contradiction to an order issued by commandant Höß calling for caution during the fumigation of barracks with Zyklon B¹⁶² – caution which had become necessary in view of several cases of poisoning. This special order of the commandant warning of accidents involving Zyklon B gas, an order which was distributed throughout the camp, indicates a duty of care with regards to those inmates who were, allegedly and nevertheless, doomed to die from the effects of that same gas sooner or later. We will have occasion to speak of Höß’s testimony at a later time.

Pressac, moreover, explains the form and basic tone of the testimony of SS man Pery Broad as incorrect because this testimony is soaked in Polish patriotism, to say nothing of the transparent Polish hatred against SS men, although Broad was an SS man himself and had no links to Poland, and because Pressac found out that this “testimony” has been slightly reworked by the Poles, the original of which is missing. In other words, this “document,” obviously patched together by the Poles, is quite worthless insofar as a critical examination of its source is concerned. Nevertheless, Pressac considers the basic testimonies with regards to homicidal gassings to be correct.¹⁶⁴

The “gas chamber” in the main camp is a room in a ground level building, which replaced a former kitchen building of the former Austro-Hungarian barracks located at the same spot.¹⁶⁵ The floor and ceiling of Crematorium I are of reinforced concrete, while the exterior walls are of brick masonry, insulated on the exterior by a coating of tar. Except for the access ways, the building is practically underground due to the fact that dirt has been piled up against the walls. The interior walls are plastered and whitewashed.

Fig. 22 shows the floor plan of the building at the beginning of the war, planned and constructed as a normal crematorium with a morgue.¹⁶⁶ This also explains the piles of dirt, which were intended to ensure an even, cool temperature. For the same reason, the partition between the morgue and the oven room is double-walled with a heat-insulating air-barrier in between.

¹⁶⁴ *Ibid.*, pp. 126-128.

¹⁶⁵ *Ibid.*, p. 129.

¹⁶⁶ *Ibid.*, pp. 151/153.

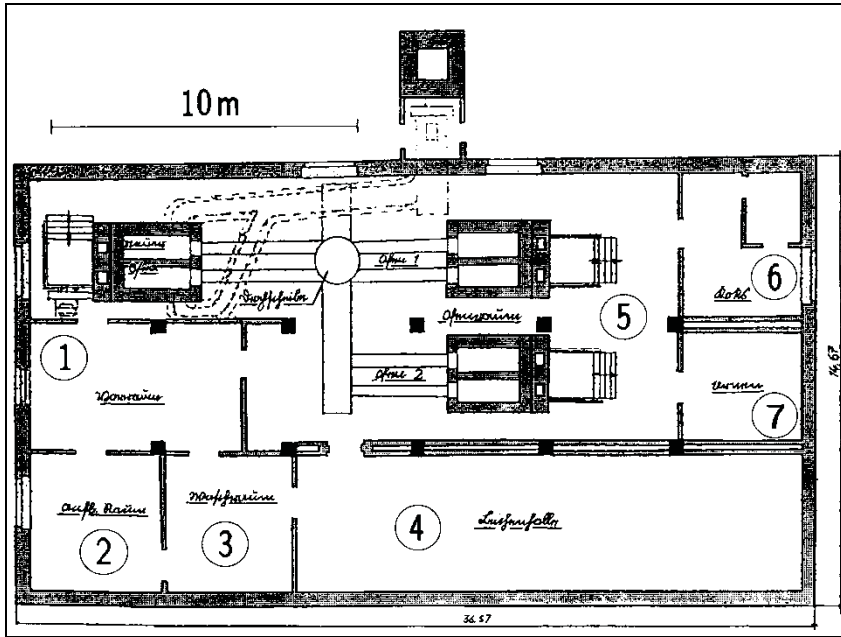

Fig. 22: Ground plan of Crematorium I in Auschwitz I/main camp in its original condition. The morgue was later alleged to have been used as a “gas chamber.”¹⁶⁶

- 1: Vestibule; 2: Laying-out room; 3: Wash room; 4: Morgue;
5: Oven room; 6: Coke; 7: Urns

Mattogno has found documentary evidence that this morgue had a ventilation system, which worked rather poorly, though. This prompted SS-Untersturmführer Maximilian Grabner, head of the Auschwitz Political Department, in June 1941 to urge the installation of a better system.¹⁶⁷

Sometime between late 1941 and early 1942 the morgue is said to have been “converted” into a “gas chamber.” On this occasion, three to four holes are claimed to have been pierced through the roof for the introduction of the Zyklon B for homicidal gassings, as well as two holes for the incorporation of heavy ventilators.¹⁶⁸ The head of the Auschwitz Museum, Franciszek Piper, however, opines that:¹⁶⁹

“In the case of Crema I there were no ventilators. The doors were opened and the gas was allowed to ventilate by convection.”

¹⁶⁷ C. Mattogno, *Auschwitz: Crematorium I and the Alleged Homicidal Gassings*, Theses & Dissertations Press, Chicago 2005p. 17-22, here p. 19.

¹⁶⁸ *Ibid.*, pp. 131f.

¹⁶⁹ D.D. Desjardin, “My Visit to Auschwitz-Birkenau, May 30-31, 1996,” interview mit F. Piper, www.codoh.com/newvoices/nddd/ndddausch.html.

Pressac reproduces a photo of the roof of the crematorium, taken by the Soviets shortly after the liberation, in which three dark spots on the roofing felt are alleged to be troughs of former Zyklon B introduction holes, allegedly now covered up.^{168,170} The photograph reproduced in his book is, however, too poor in quality to permit anything to be seen with clarity, much less permitting any conclusion as to the construction or engineering. Pressac's speculation must therefore be viewed as groundless.

In the autumn of 1944, the crematorium was converted into an air raid shelter. The alterations made, especially the replacement of the thin partitions by thick walls, can be seen in Fig. 23.¹⁷¹ The alleged Zyklon B introduction holes as well as the ventilation holes are alleged to have been sealed at that time – assuming that they ever existed.

The building work undertaken for this conversion is described in a

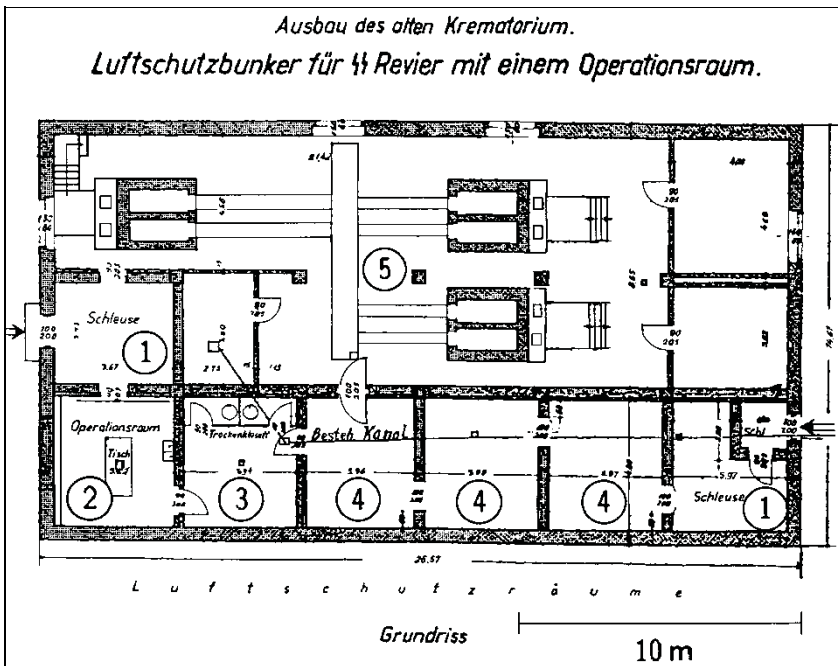

Fig. 23: Ground plan of Crematorium I Auschwitz I Main Camp after conversion to air raid shelter, 1944.¹⁷¹

1: Sluice; 2: Operating room; 3: Former washroom, now air raid shelter with toilet; 4: Air raid shelter; 5: Former oven room.

¹⁷⁰ J.-C. Pressac, *op. cit.* (note 72), p. 149; photograph of the roof of Crematorium I immediately after the liberation.

¹⁷¹ *Ibid.*, p. 156.

document in the smallest detail.¹⁷² There is no mention of any filling in of any old existing holes pierced through the roof, but rather of the incorporation of gas-tight windows and doors as well as the piercing of new holes:

“Installation of gas-tight doors, window shutters, and windows,

Manufacture of openings in the masonry necessary for the heating ovens, as well as for the ventilation outlets and intakes and pipes.”

This is a strong indication that before this time there were neither gas-tight doors and windows nor any large openings which would have required to be closed (Zyklon introduction holes).

Direct access to the air raid shelters, which evolved from the multiple division of the morgue/“gas chamber,” was possible through a newly added entrance with sluice/air lock, which today is represented as the entryway taken by the victims, although the “gas chamber” had no entrance in that location – as a matter of fact, it had no direct entrance from the outside at all.¹⁶⁸ Toilets were likewise built into the former

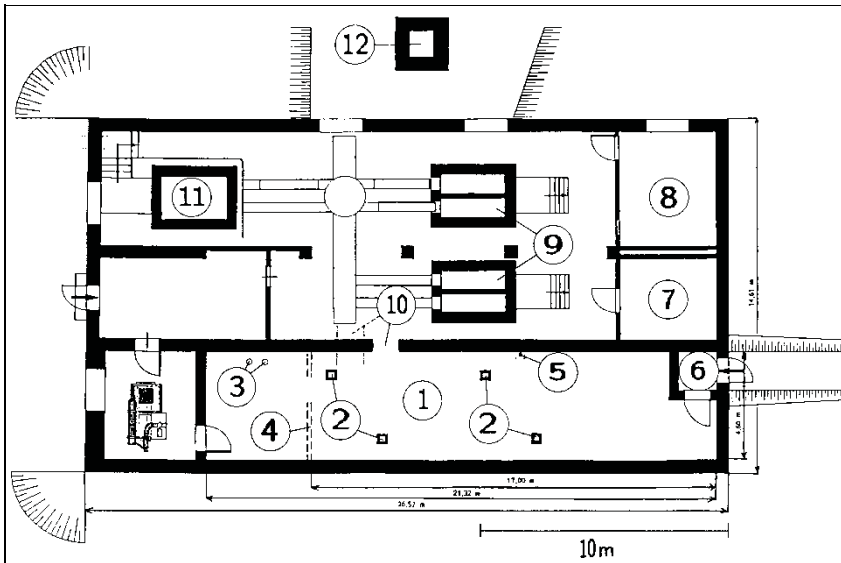

Fig. 24: Ground plan of Crematorium I in Auschwitz I/Main Camp today, after subsequent fakery.¹⁷³

1: “Gas chamber”; 2: Fake Zyklon B introduction holes; 3: Toilet drains; 4: former partition morgue-washroom; 5: Ventilation chimney from air raid shelter; 6: Air lock, today referred to as victim entryway; 7: Urns; 8: Coke; 9: Reconstructed ovens; 10: Newly pierced entry to oven room; painted: old entryway; 11: Remains of the old oven; 12: Fake chimney.

¹⁷² “Herstellung der für die Beheizungsöfen, sowie für die Ent- und Belüftung erforderlichen Mauerdurchbrüche und Schläuche,” letter from the Auschwitz Air Raid Warden, Aug. 26, 1944, *RGVA* 502-1-401.

washroom at this time.

Fig. 24 shows the floor plan of the crematorium in its present condition.¹⁷³ According to Pressac, the access from the morgue/“gas chamber” to the present cremation room was newly placed after the war – not quite at the original location. The partitions in the air-raid shelter, including the wall to the washroom, which was, however, never part of the morgue (the later “gas chamber”), were torn down. Accordingly, the perplexed visitor sees two discharge pipes from two toilets inside the alleged “gas chamber.” According to Pressac, who gives no source for this statement, the roof was newly covered with tarred roof felt. As a result, the traces of the Zyklon B holes and ventilation holes of the “gas chamber” were allegedly covered over. The renewed incorporation of four staggered Zyklon B introduction stacks by the Polish museum after the war is therefore not alleged to have taken place in the same location. Pressac’s argument must cause astonishment, though, since the roof/ceiling is of unplastered bare concrete on the inside. It should have been quite easy to determine the location of the original openings – now allegedly sealed – from the interior, and it would also have been quite easy to reopen them.

As confirmed to visitors by the museum administration upon inquiry, the two chimney openings in the cremation room, as well as the chimney itself, which is without any functional connection outside the building, were built after the war as a “reconstruction for museum purposes” on the location of the alleged original installations.¹⁷⁴

The French journalist and well-known anti-revisionist, Eric Conan, writes:¹⁷⁵

*“Another delicate subject: What to do with the **falsifications** left behind by the communist administration? In the 50s and 60s, several buildings*

¹⁷³ J.-C. Pressac, *op. cit.* (note 72), p. 159.

¹⁷⁴ *Ibid.*, p. 133; see also the confirmation of changes in the partial recreation of the installation in the letter from the Auschwitz State Museum to Joel P. Hayward, ref. I-8523/26/2120/ 91, dated May 7, 1991; B. Bailer-Galanda, *Informationen der Gesellschaft für politische Aufklärung*, Innsbruck, June 1991, no. 29, p. 1, relating to Leuchter’s statement relating to Crematorium I: “Er verwechselt museale Rekonstruktionen der Gaskammern, die dem Betrachter einen Eindruck der damaligen Geschehnisse vermitteln sollen, mit real funktionierenden Gaskammern.” (He confuses a museum reconstruction of the gas chambers, intended to provide the observer with the impression of the events at that time, with authentically functioning gas chambers.); Letter from Dr. Scheel, Bonn, German Foreign Office, Jan. 8, 1979, ref. 214-E-Stuparek: “Auch mir ist bekannt, daß es im Lager Auschwitz keine Gaskammern gegeben hat. Die Gaskammern befanden sich im ca. 3 km davon entfernten KZ Auschwitz-Birkenau.” (I know as well that there were no gas chambers in Auschwitz camp. The gas chambers were located in the Auschwitz-Birkenau camp, located approximately 3 km away.)

¹⁷⁵ “Auschwitz: la mémoire du mal,” *L’Express*, 19-25 January 1995; see also, in this regard, Robert Faurisson’s remarks: “Sur Auschwitz, lentement, la vérité reprend ses droits” (The truth about Auschwitz is slowly reclaiming its rights), Feb. 4, 1995.

which had disappeared or had been misappropriated were rebuilt with gross errors and displayed as authentic. Some, which were 'too new,' have been closed to the public. Not to mention the delousing gas chambers, which were sometimes presented as homicidal gas chambers. Those aberrations have helped the deniers a lot, which took the essence for their legends out of them. The example of the Crematory I is typical. In its morgue, the first gas chamber was installed. It operated for a short period of time in early 1942. The blocking of this area, which was essential for the gassings, disturbed the operation of the camp. End of April 1942, it was therefore decided to move the deadly gassings to Birkenau, where it was conducted on an industrial scale mainly with Jewish victims. The Crematory I was subsequently converted into an air raid shelter with a surgery room. In 1948, when the museum was created, Crematory I was reconstructed in a supposed original state. **Everything in it is false.**^[176] the dimensions of the gas chamber, the locations of the doors, the openings for pouring in Zyklon B, the ovens, rebuilt according to the recollections of some survivors, the height of the chimney. At the end of the 70s, Robert Faurisson exploited those **falsifications** all the better because at that time the museum officials balked at admitting them.^[177] An American revisionist^[179] has shot a video in the gas chamber, still presented as authentic: one may see him questioning the visitors with his 'revelations.' [...] For the moment, things remain as they are, and **the visitors are not told anything**. This is too complicated. One shall see later what to do." (Emphases added.)

According to the inflection: they were lying, they are lying, they will be lying...

In view of this unrealistic "reconstructions" carried out after the war, the Jewish-American "professor of architecture" Robert van Pelt, who actually is only a professor of cultural history, in co-operation with the Jewish-Canadian Holocaust historian Deborah Dwork, arrives at the following, no less unequivocal conclusions:¹⁷⁸

"The architecture designed to enact the metamorphosis from Mensch to Untermensch was intact when the Soviets liberated the camp in 1945. All traces of it were removed subsequently. The guidebook for sale in the bookstore does not mention the building [Crematorium I] at all. Perhaps the men and women who created the museum could not reconcile its implications with their ideology of a resistance: an ideology that denied total victimization. Perhaps it was simply a question of resources and the need for tourist services. Whether for doctrinal or practical reasons, the destruc-

¹⁷⁶ In the original: "Tout y est faux: [...]"

¹⁷⁷ See Serge Thion (ed.), *op. cit.* (note 37), pp. 316f.; R. Faurisson, "The Gas Chambers...", *op. cit.* (note 39), p. 335.

¹⁷⁸ *Op. cit.* (note 97), pp. 363f.

tion of the original arrangement within the present visitor reception center is a postwar obfuscation and a loss.

There have been additions to the camp the Russians found in 1945 as well as deletions, and the suppression of the prisoner reception site is matched by the reconstruction of Crematorium I just outside the northeast perimeter of the present museum camp. With its chimney and its gas chamber, the crematorium functions as the solemn conclusion for tours through the camp. Visitors are not told that the crematorium they see is largely a postwar reconstruction.

When Auschwitz was transformed into a museum after the war, the decision was taken to concentrate the history of the whole complex into one of its component parts. The infamous crematoria where the mass murders had taken place lay in ruins in Birkenau, two miles away. The committee felt that a crematorium was required at the end of the memorial journey, and Crematorium I was reconstructed to speak for the history of the incinerators at Birkenau. This program usurpation was rather detailed. A chimney, the ultimate symbol of Birkenau, was re-created; four hatched openings in the roof, as if for pouring Zyklon B into the gas chamber below, were installed, and two of the three furnaces were rebuilt using original parts. There are no signs to explain these restitutions, they were not marked at the time, and the guides remain silent about it when they take visitors through this building that is presumed by the tourist to be the place where it happened.”

This argument of the “usurpation” is packed with dynamite, because it suggests that the events alleged to have taken place in Crematorium I, events described by eyewitnesses Rudolf Höß, Pery Broad and a few others, actually never took place at this location. But this undermines the credibility of all other eyewitnesses from the very outset, including those from Birkenau. We wonder if the authors are aware of this?

It may at least be stated without fear of contradiction that the ceiling, exterior walls and pillars as well as the foundation of crematorium are in their original condition. If Zyklon B introduction stacks and ventilation openings had existed in the reinforced concrete roof, breaks in the reinforced concrete structure would be visible from the interior in the corresponding places, since these cannot have been made to disappear without leaving visible traces.

In addition to today’s Zyklon B introduction stacks there are indeed three locations in what is presented today as the “gas chamber,” where the concrete has been breached in a circular pattern, which indicates that these may have been round holes. (Another one is located in the air lock, see Fig. 27, 1-4)



Figs. 25 and 26: Two of the four former openings through the roof of the morgue of Crematorium I in Auschwitz Main Camp, visible at the ceiling. They probably served as ventilation openings for the air raid shelter in 1944. They have been closed after the war “for museum purposes,” because their location makes it obvious that they couldn’t have served as Zyklon B introduction holes.

The four openings in the concrete in existence today and presented as “Zyklon B introduction shafts” (marked A to D in Fig. 27) are neither plastered, nor have the remains of the cut steel reinforcement rods been removed in a professional manner. The holes have been planked with wood and sealed with tar. Such poor workmanship reflects neither the care required in handling a poisonous gas, nor standard German craftsmanship.

If the SS had put these holes in the concrete during the war, one must assume that they would have taken care to evenly distribute these holes in the ceiling of the original(!) morgue in order to ensure an even distribution of the Zyklon B inside the room. The stacks today, however, are only evenly distributed in the ceiling of this room if one considers the washing room, which was only incorporated after the war(!), as an integral part of the morgue (“gas chamber”; see Figs. 22 and 24). Thus, the arrangement of today’s introduction holes only make sense, if they were created especially for its present status as a falsely dimensioned “reconstruction for museum purposes” (B. Bailer-Galanda)¹⁷⁴ after the war. This by itself is strong circumstantial evidence that those holes were chiseled in after the interior walls of the former air raid shelter – one too many of them – had been torn down by the Soviets or the Poles. This is also supported by the fact that it has been generally assumed until the present day – without contradiction by any side – that the introduction holes visible today were indeed created *after* the war *without* recourse to the alleged remains of old, walled-up holes.¹⁷⁹

¹⁷⁹ See, in this regard, the interview with David Cole, “David Cole in Auschwitz,” 1993; www.youtube.com/watch?v=iXKHw0EZrQM; partially printed as “David Cole Interviews Dr.

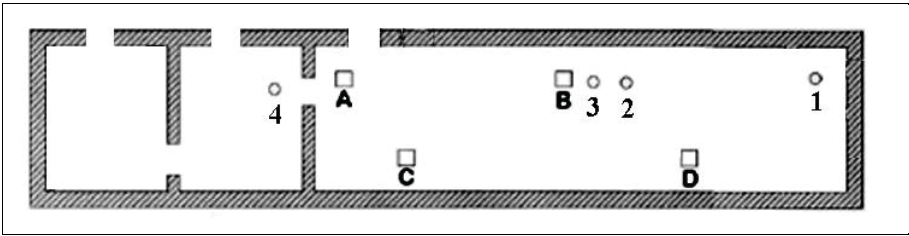

Fig. 27: Schematic floor plan of the morgue of Crematorium I (original situation) with surgery room (left) and washing room (with opening no. 4). A,B,C,D: location of current openings in the roof made after the war. 1, 2, 3, and 4: location of original openings of the air raid shelter for ventilation and heating ducts, today closed.¹⁸⁰

As mentioned earlier, there are four circular spots of some 35 cm in diameter visible in the ceiling of Crematorium I, which at some point might have been holes going all the way through the roof. They have been crudely filled with plaster, but since the reinforcement iron bars have not been removed from these holes, these iron bars are rusting.¹⁸¹ Due to this the plaster comes crumbling down, which the museum's janitors diligently sweep away. Fig. 27 shows their location (1-4), together with the four openings included after the war "for museum purposes" (A-D). The walls shown are as they have been when the building was allegedly used as a "gas chamber." It is obvious that these old opening cannot have anything to do with alleged Zyklon B introduction holes:

1. Hole 4 is located in the wash room, not in the morgue, which was allegedly misused as a "gas chamber."
2. Hole 1 is in a corner of the morgue where the air lock of the air raid shelter was located (see. Fig. 23), which is falsely labeled "victims' entry" today. It is therefore reasonable to assume that this hole as well as the others served as ventilation openings for the shelter.

Franciszek Piper, Director, Auschwitz State Museum," *Journal of Historical Review*, 13(2) (1993), pp. 11-13.

¹⁸⁰ Taken from C. Mattogno, "The Openings for the Introduction of Zyklon B," *The Revisionist*, 2 parts, 2(4) (2004i), pp. 411-436, here p. 413, slightly adapted (an earlier version of this paper is available online: www.vho.org/GB/c/CM/noholes.html).

¹⁸¹ Steel reinforcement rods in concrete are only practicable when the iron is deeply embedded in the concrete and therefore protected for decades against corrosion by the very durable alkaline environment of the concrete, since concrete is only slowly carbonated by the carbon dioxide (CO₂) in the environment, resulting in a neutralization of its pH value. The reinforcement rods in the ceiling of the morgue in question have been exposed to the surface, and the thin patches of mortar of dubitable quality cannot protect it efficiently, so the pH value drops quickly (*i.e.*, becomes less alkaline), particularly when rain water containing CO₂ penetrates the concrete; see the crack in Fig. 25, which would quickly allow the entry of rain water.

3. The steel reinforcement rods have not been removed from these holes. That would not have prevented them from being used as ventilation holes for a shelter, but it would have made it difficult to render the hole gas-proof.
4. The distribution of the holes over the morgue's roof/ceiling is so irregular that it can be excluded with technical certainty that they served to distribute anything throughout the former morgue.
5. Mainstream historiography, basing itself on witness statements, claims that the openings were square or rectangular. These holes are circular.

Based on all these arguments, it can be concluded with certainty that at the time of the alleged use of this room as a "gas chamber," there were no openings for the introduction of Zyklon B. Furthermore, there was no direct access to the "gas chamber" from the outside. The victims would have had to enter through the corpse room (laying out room), or through the oven room. They would, therefore, have had to file past the corpses of their already-murdered companions in misery – truly a macabre spectacle. There could be no successful deception of the victims and camouflage, nor could there be any hope of willing co-operation or acquiescence on the part of the inmates under such circumstances. Or, to put the lack of direct access doors to the "gas chamber" in Robert Faurisson's words:

"No doors, no destruction."

5.4. "Gas Chambers" in the Birkenau Camp

5.4.1. Crematoria II and III

5.4.1.1. Point of Departure

These crematoria are entirely comparable in size, equipment, and manner of construction to other similar installations built in the Third Reich at that time, as well as with those built today.¹⁸² In this connection, reference is made to the trial of the builder of the cremation installations in Birkenau camp. In 1972, the court acquitted the two defen-

¹⁸² The present writer has before him a sketch of the ground plan of the crematorium, built in 1939, of the Sachsenhausen concentration camp, which is similar in design and dimensions with Crematoria II and III at Auschwitz, yet no mass murders are alleged to have occurred at Sachsenhausen. Compare with this the construction design of modern crematoria: H.-K. Boehlke, *Friedhofsbauten*, Callwey Verlag, Munich 1974, in particular, the crematorium diagram on p. 117, including a doctor's office; cf. E. Neufert, *Bauentwurfslehre*, Ullstein Fachverlag, Frankfurt 1962, pp. 423f.

dants, master builder W. Dejaco and master builder F. Ertl, since suspicion of aiding and abetting in mass murder could not be corroborated.¹⁸³ An expert report drawn up during this trial on the surviving plans and documents on the construction of the crematoria led to the conclusion that these buildings could not have been used or modified so as to serve as instruments of mass murder.⁹⁰ In interview with Walter Lüftl, one of the master builders at Auschwitz, Walter Schreiber, stated as follows on the planning of these crematoria:¹⁸⁴

“Lüftl: In which areas were you active?”

Schreiber: As senior engineer I inspected the civil project of the Huta Corporation and negotiated with the Central Construction office of the SS. I also audited the invoices of our firm.

L.: Did you enter the camp? How did that happen?

S.: Yes. One could walk everywhere without hindrance on the streets of the camp and was only stopped by the guards upon entering and leaving the camp.

L.: Did you see or hear anything about killings or mistreatment of inmates?

S.: No. But lines of inmates in a relatively poor general condition could occasionally be seen on the streets of the camp.

L.: What did the Huta Corporation build?

S.: Among other things, Crematoria II and III with the large morgues.

L.: The prevalent opinion (considered to be self evident) is that these large morgues were allegedly gas chambers for mass killings.

S.: Nothing of that sort could be deduced from the plans made available to us. The detailed plans and provisional invoices drawn up by us refer to these rooms as ordinary cellars.

L.: Do you know anything about introduction hatches in the reinforced concrete ceilings?

S.: No, not from memory. But since these cellars were also intended to serve as air raid shelters as a secondary purpose, introduction holes would have been counter-productive. I would certainly have objected to such an arrangement.

L.: Why were such large cellars built, when the water table in Birkenau was so extremely high?

S.: I don't know. Originally, however, above-ground morgues were to be built. The construction of the cellars caused great problems in water retention during the construction time and sealing the walls.

¹⁸³ Proceedings against master builders W. Dejaco and F. Ertl (note 89).

¹⁸⁴ Schreiber was the Supervising Engineer at the Kattowitz agency of the Huta corporation, which built the crematoria at Birkenau. See also Werner Rademacher (=Walter Lüftl), “Engineer’s Deathbed Confession: We Built Morgues, not Gas Chambers,” *The Revisionist* 2(3) (2004), pp. 296-297. He died in 1999.

- L.: Would it be conceivable that you were deceived and that the SS nevertheless had gas chambers built by your firm without your knowledge?*
- S.: Anyone who is familiar with a construction site knows that is impossible.*
- L.: Do you know any gas chambers?*
- S.: Naturally. Everyone in the east knew about disinfestation chambers. We also built disinfestation chambers, but they looked quite different. We built such installations and knew what they looked like after the installation of the machinery. As a construction firm, we often had to make changes according to the devices to be installed.*
- L.: When did you learn that your firm was supposed to have built gas chambers for industrial mass killing?*
- S.: Only after the end of the war.*
- L.: Weren't you quite surprised about this?*
- S.: Yes! After the war I contacted my former supervisor in Germany and asked him about it.*
- L.: What did you learn?*
- S.: He also only learned about this after the war, but he assured me that the Huta Corporation certainly did not build the cellars in question as gas chambers.*
- L.: Would a building alteration be conceivable after the withdrawal of the Huta Corporation?*
- S.: Conceivable, sure, but I would rule that out on the basis of time factors. After all, they would have needed construction firms again, the SS couldn't do that on their own, even with inmates. Based on the technical requirements for the operation of a gas chamber, which only became known to me later, the building erected by us would have been entirely unsuitable for this purpose with regard to the necessary machinery and the practical operation.*
- L.: Why didn't you publish that?*
- S.: After the war, first, I had other problems. And now it is no longer permitted.*
- L.: Were you ever interrogated as a witness in this matter?*
- S.: No Allied, German, or Austrian agency has ever shown an interest in my knowledge of the construction of Crematoria II and III, or my other activities in the former Generalgouvernement [German occupied Poland]. I was never interrogated about this matter, although my services for the Huta Corporation in Kattowitz were known. I mentioned them in all my later CVs and recruitment applications. Since knowledge about these facts is dangerous, however, I never felt any urge to propagate it. But now, as the lies are getting increasingly bolder and contemporary witnesses from that time like myself are slowly but surely dying off, I am glad that someone is willing to listen and to write down the way it really*

was. I have serious heart trouble and can die at any moment, it's time now."

Prof. van Pelt has stated as follows on Crematorium II:¹⁸⁵

"Auschwitz is like the holy of holies. I prepared years to go there and to have a fool [Leuchter] come in, come in completely unprepared, it's sacrilege. Somebody who walks into the holy of holies and doesn't give a damn." [00:40:59-00:41:20]

"Crematorium II is the most lethal building of Auschwitz. In the 2,500 square feet of this one room, more people lost their lives than any other place on this planet. 500,000 people were killed. If you would draw a map of human suffering, if you created a geography of atrocity, this would be the absolute center." [00:55:44-00:56:15]

Van Pelt's testimony emphasizes the importance of Crematorium II (and Crematorium III, built as a mirror image of Crematorium II, although allegedly not used quite as intensively), which will be discussed in the following.

A special, separate morgue with better ventilation was then used, as is usual today, as a laying out room for the victims of possible epidemics. This cellar is designated as an "*Infektionsleichenkeller*" (infection corpse morgue) in the technical literature. Fig. 28 is the floor plan of Morgue 1 (alleged "gas chamber") of Crematorium II, which was designed mirror-symmetrically to Crematorium III. Fig. 29 shows the cross section through Morgue 1.¹⁸⁶ As may be seen from the cross-section, these morgues, for the most part, are located below ground. The long and slender type of construction, the underground location, as well as the lack of contact with the cremation rooms result in an even, cool temperature in these areas. This corresponds to their having been planned as morgues, which is how they are designated in the building plans.

The planning of such large cellars is not astonishing, furthermore, when one considers that several hundred corpses a day had arrived during the worst periods of the epidemics raging in Auschwitz, and that these corpses had to be stored somewhere. The compelling interpretation of the non-criminal planning of these rooms as harmless morgues is shared even by Pressac.

¹⁸⁵ van Pelt's testimony in Errol Morris' documentary movie *Mr Death*, *op. cit.* (note 10), internet version; time given in [min:sec:frame].

¹⁸⁶ J.-C. Pressac, *op. cit.* (note 72), pp. 319-329. Plans for Crematoria II and III.

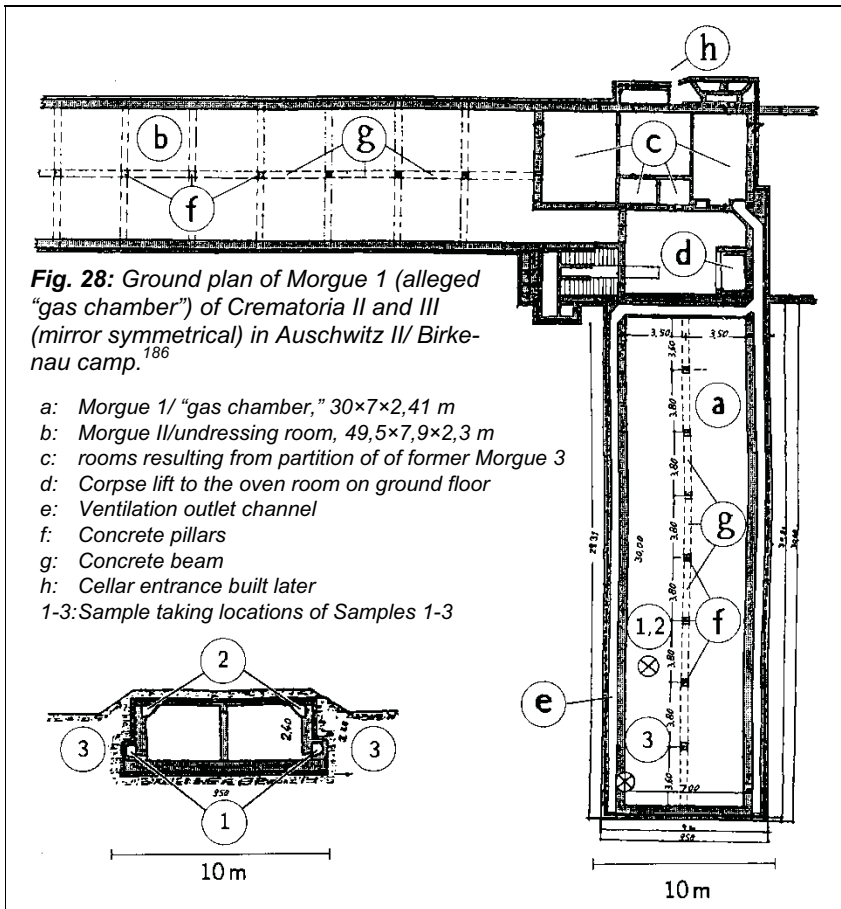

The documentation reproduced by Pressac shows that this installation was derived from an earlier 1941 plan for a new crematorium in the main camp.¹⁸⁷ The access road to the crematoria in Birkenau was located on the side of the chimney wing (see Fig. 31). The original plan for the main camp, however, provided for an access road on the other side of the building. Moreover, the high water table of the terrain in

¹⁸⁷ *Ibid.*, p. 183, on the non-criminal planning of Crematoria II and III, see, in particular, p. 264.

Birkenau did not permit location of the morgue quite under ground.¹⁸⁸ The cellars were therefore raised so as not to swim on top of the ground water. Together with the layer of earth on top of the cellars, these were insurmountable for vehicles and carts. Direct access to the cellars from the outside was therefore blocked. For this reason, an additional flight of stairs was incorporated to the offices of Morgue 3 as well as a flight of stairs at the end of Morgue 2 (see Fig. 31).

Possibly as a result of the dramatically altered military situation after the German defeat of Stalingrad in the winter of 1942-43, all construction plans were reduced in costs and required manpower wherever possible. Hence, the new stairways did not have corpse chutes as the old stairway. Several other cost-reducing changes were made on Crematorium III.¹⁸⁹ Defects in the quality of the cheap material used for Crematoria IV and V must have led to their early breakdown (see chapter 5.4.2.).

The original basement stairways with corpse chutes of Crematoria II and III had already been finished by then, although they could only be accessed with difficulty. That these stairs were built at all, indicates a hasty transmission of the old plans for the main camp to the new situation in Birkenau.

The walls of the morgue consist of double brick masonry with a layer of waterproofing in between for insulation.¹⁸⁹ The interior walls are plastered with a hard, cement-rich material, the ceiling and support pillars of reinforced concrete show the marks of wooden planking and are therefore not plastered. The roof, made of reinforced concrete, is isolated by a layer of tar, which is protected from environmental and mechanical damage by a rather thin layer of cement covering it. The layers of tar both on top of the roof as well as between the two brick walls were indispensable as a water barrier due to the high ground water in the swampy region of Birkenau. Both morgues had several drains.

5.4.1.2. The Obsessive Search for “*Criminal Traces*”

Jean-Claude Pressac was the first researcher to dig through the mountains of documentation at the Auschwitz Museum and later through the documentation of the Central Construction Office stored in Moscow. He was also the first one to create the now-widely used term

¹⁸⁸ See also Michael Gärtner, Werner Rademacher, “Ground Water in the Area of the POW camp Birkenau,” *The Revisionist*, 1(1) (2003), pp. 3-12; C. Mattogno, “Cremation Pits” and Ground Water Levels at Birkenau,” *The Revisionist*, 1(1) (2003), pp. 13-16.

¹⁸⁹ J.-C. Pressac, *op. cit.* (note 72), p. 187, costs and survey of construction design of Crematoria II and III.

“criminal trace.” Based on the total absence of documents proving the erection of homicidal “gas chambers,” Pressac resorted to a semantic trick by attributing a criminal significance to harmless documents, which were said to constitute a clue that something was not quite right about the crematoria at Auschwitz. Based on the progress in research, however, all these “criminal traces” compiled by Pressac and others and accompanied by sometimes fantastic cerebral acrobatics have collapsed.¹⁹⁰ The most notable of them are listed and briefly refuted in the following.

5.4.1.2.1. New Cellars Stairways

Fact 1: Additional access ways via stairways from the outside were later incorporated into the cellars of Crematoria II and III.

Incorrect additional allegation: The corpse chute at the old, original stairway entrance was demolished.¹⁹¹

Incorrect conclusion: The construction of new stairways *without* corpse chutes with the simultaneous demolition in the original stairway access way could mean only one thing: no more corpses were to go sliding into the cellars but rather people who were still able to walk down a few steps. Hence they had to be alive while entering, and were killed *after* they had entered the building.¹⁹²

Correct conclusion: The new stairways were necessary based on the alteration in the plans, see the chapter above. This is supported by the heading of the plan for the new stairways: “Change of cellar access to street side.”¹⁹³ The corpse chute, furthermore, wasn’t even demolished. In fact, it appears in all following plans as shown by Carlo Mattogno:¹⁹⁴

- *Plan 2136 of the Central Construction Office of 22 February 1943 for Crematorium III;*¹⁹⁵
- *Plan 2197 of the Central Construction Office of 18 March 1943 for Crematorium II;*¹⁹⁶
- *Plan 109/15 of the firm Huta of 24 September 1943 for Crematoria II and III;*¹⁹⁷

¹⁹⁰ See in particular C. Mattogno, *op. cit.* (note 76), pp. 25-228.

¹⁹¹ Judgment of Judge Gray, D. Irving vs. D.E. Lipstadt, *op. cit.* (note 71), §7.61, 13.76, 13.84.

¹⁹² On Gray, see preceding footnote; J.-C. Pressac, *op. cit.* (note 72), pp. 213, 218.

¹⁹³ J.-C. Pressac, *op. cit.* (note 72), pp. 183f., 302f.; with regards to the original plans by Walter Dejaco, see J.-C. Pressac, *op. cit.* (note 95), Document 9.

¹⁹⁴ The following list was taken from Carlo Mattogno’s “Architektonische Stümpereien...,” *op. cit.* (note 97), p. 29.

¹⁹⁵ J.-C. Pressac, *op. cit.* (note 72), p. 305.

¹⁹⁶ *Ibid.*, p. 307.

¹⁹⁷ *Ibid.*, p. 327.

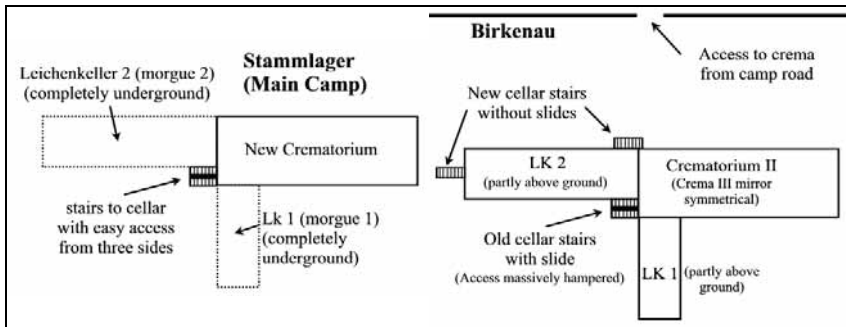

Fig. 30: Schematic location of the new crematorium as originally planned for the Auschwitz main camp.

Fig. 31: Schematic location of Crematorium II, altered plan. To adjust it to the higher location of the morgue and the access in Birkenau from the other side (mirroring Crematorium III).

– Plan 109/16A of the firm Huta of 9 October 1943 for Crematoria II and III.¹⁹⁸

Moreover, the ‘chute’ is mentioned as existing in ordinances 200 and 204 of the Central Construction Office to the inmate locksmith shop of 18 March 1943 respecting Crematorium II.¹⁹⁹ “

Moreover, Crematoria II and III were undoubtedly used during their entire period of operation for the temporary storage of the bodies of persons having died of “natural” causes (epidemics, exhaustion, age, etc.), awaiting cremation, which amounted to at least thousands of bodies. If it were true that stairways without chutes could only be used by living persons still capable of climbing stairs on their own, then one might be permitted to ask: how did the corpses of persons having died of “natural” causes get into the morgue (or wherever they were stored)? Did they walk by themselves? Of course not. They were carried, and sometimes certainly even a few steps up and down – and not only inside the crematorium. Was it therefore impossible to get corpses into a building not having a chute? Certainly not. Would missing chutes therefore prove that only living people could enter? Of course not. So why did the SS not build a new corpse chute by the new stairway? Perhaps simply because the costs of the crematorium were running out of control due to the constant changes in plans, and because it was desired or necessary to keep the costs down? Would that not be a much simpler and more logical explanation?

¹⁹⁸ *Ibid.*, p. 328.

¹⁹⁹ *The Trial of Höß*, volume 11a, p. 88.

5.4.1.2.2. Gassing Cellar, Undressing Room, and Showers

Fact 1: There are documents of the SS Central Construction Office which mention an “*Auskleidekeller*” (undressing room) in Crematorium II.²⁰⁰

Fact 2: There is a document which mentions a “*Vergasungskeller*” (gassing cellar,) in Crematorium II.²⁰¹

Fact 3: There is a document which lists “*14 Brausen*” (14 showers) for Crematorium III.²⁰²

Fact 4: Pieces of wooden planking left in the underside of the ceiling of Morgue 1 in Crematorium II are visible even today.²⁰³

Incorrect conclusion: Morgue 1 of Crematoria II & III was built as homicidal “gas chamber,” equipped with “false” shower heads, which were fastened to the pieces of wood left in the concrete and used to deceive the victims; Morgue 2 was used as the undressing room for the victims.²⁰⁴

Correct conclusions: The term “*Vergasungskeller*” does not clarify, in which way “gas” and “cellar” are linked here: for homicidal, for disinfestation, or for other purposes? This can be deduced from a different document, though: a memo of the Topf firm written on February 17, 1943, which states, among other things:²⁰⁵

“Herr Schultze called and informed us as follows: The aeration blower no. 450 for the gas cellar [Gaskeller] cannot be found there [i.e. at Auschwitz], although it is said to have been shipped by us.”

The term “*Gaskeller*” was obviously used for the same room, and from the ventilation system described in this document it derives that it was Morgue 1. As A.R. Butz rightly pointed out, this technical term refers to a gas shelter, i.e., to a room providing safety from air raids with poison gas.²⁰⁶ Samuel Crowell has thoroughly documented the German wartime regulations for the construction of air raid shelters,²⁰⁷ which made their inclusion in new structures obligatory. Since Crema-

²⁰⁰ J.-C. Pressac, *op. cit.* (note 72), pp. 433ff.

²⁰¹ *Ibid.*, p. 432.

²⁰² *Ibid.*, p. 430.

²⁰³ *Ibid.*, p. 488.

²⁰⁴ See also four Pressac footnotes above; see also Gray, judgment, *op. cit.* (note 71), §13.69, 13.82.

²⁰⁵ First mentioned by Jean-Claude Pressac, “Une critique sur le fond,” *L’Autre Histoire*, no. 6, Oct. 16, 1996, pp. 9-14. The document was made available in a brochure in 2005 prepared for an exhibition on Topf & Sons in Germany, within the context of a Holocaust memorial exhibition at the Berlin Holocaust Museum, which took place from January to April in 2006. It is reproduced online at www.codoh.com/incon/incontopf.html.

²⁰⁶ A.R. Butz, *op. cit.* (note 36), p. 446, with reference to two Russian-German dictionaries.

²⁰⁷ S. Crowell, “Defending Against the Allied Bombing Campaign: Air Raid Shelters and Gas Protection in Germany, 1939-1945,” www.codoh.com/incon/inconabr.html.

toria II & III were the only solid structures with basements in the Birkenau camp, it is logical to assume that at least one room in the basements of these buildings was designed to serve as a gas-tight air raid shelter in case of need. As we have seen before, this was also confirmed by the senior engineer involved in the construction of these building (see p. 83). Hence, the use of the term “*Vergasungskeller*” in the document mentioned above may simply have been a misnomer for “*Gaskeller*.”

Regarding the alleged fake showers, it should be kept in mind that by the 1940s no proper means for drilling holes into concrete had been invented and that no neat plastic dowels existed yet. There was therefore only one way to fasten installations to bare concrete walls and ceilings: conical pieces of wood were cast into the concrete, onto which electrical lines, lamps, water pipes, and other installations were screwed tightly. The existence of such pieces of wood in the ceiling of Morgue 1 does not prove that shower heads were fastened there. It is more probable that lamps or electrical lines were fastened there. Nor is there any proof that the “showers” mentioned in the document were “false,” as stated by Pressac. In actual fact, the Central Construction Office temporarily considered expanding the Birkenau crematoria into hygiene centers equipped with disinfestation installations, inmate showers and undressing rooms, but nevertheless later abandoned these plans. Carlo Mattogno has produced extensive documentation in support of this argument:²⁰⁸

“Now in an ‘Aufstellung’ (itemization) by the Topf company dated 13 April, 1943, concerning requested metals to be used in the construction of certain machinery for Crematorium II at Auschwitz, the following piece of information appears:^[209]

‘2 Topf disinfestation heaters for Crematorium II in the prisoner of war camp Auschwitz.’

On 14 May, Bischoff sent Topf the following ‘urgent telegram’:^[210]

‘On Monday bring the overdue warm water project for approximately 100 showers. Installation of water heater or boiler in the still under construction trash incinerator Crematorium III or flue for the purpose of utilizing the high emission temperature. Contingently higher walling of the oven for the purpose of accommodating a large reserve container is possible. It is being requested to send along the appropriate designs with Herrn Prüfer on Monday, May 17.’

²⁰⁸ C. Mattogno, “Leichenkeller von Birkenau: Luftschutzräume oder Entwesungskammern?” *VffG* 4(2) (2000), pp. 152-158; Engl.: “Morgue Cellars of Birkenau: Gas Shelters or Disinfesting Chambers?,” www.vho.org/GB/c/CM/leichen.html.

²⁰⁹ *Archiwum Państwowe Muzeum w Oswiecimiu* (hereafter *APMO*), BW 30/34, p. 47.

²¹⁰ *APMO*, BW 30/34, p. 40.

On June 5, 1942, Topf sent Drawing D60446 to the Central Construction Office 'regarding the installation of the boilers in the rubbish incinerator.' This project involved the installations intended for Crematorium II.^[211]

In an undated 'questionnaire' apparently written in June 1943 regarding the Birkenau crematoria, in answer to the question, 'Are the exhaust gases utilized?,' the head of the Central Construction Office, Bischoff, responded: 'planned but not carried out,' and in response to the following question: 'If yes, to what purpose?,' Bischoff answered: 'for bath facilities in Crematorium II and III.'^[212]

Finally, there is an invoice from the firm VEDAG Vereinigte Dachpappen-Fabriken Aktiengesellschaft (United Roofing-Felt Factories, Incorporated) dated July 28, 1943, with the subject 'Auschwitz-crematorium' referring to 'completed sealing work for the disinfestation facility' (emphasis added) which was carried out between May 21 and July 16, 1943 [...].^[213]

Before drawing any conclusions, a few explanations are required. While both Topf disinfestation heaters were then installed in the Zentralsauna, the document cited above refers them to Crematorium II. The project for the installation of 100 showers in Crematorium III (and in Crematorium II) could not have been for the prisoners of the 'sonderkommando' of the crematoria, since only 50 showers were installed in the shower room of the Zentralsauna, which had been designed for the inmates of the entire camp;^[214] therefore it is clear that the 'bath facilities in Crematorium II and III' in the 'questionnaire' quoted above, were intended for the prisoners of the entire camp as well. This means that it was planned to convert the Crematoria II and III into hygienic centers.

The purpose of such centers was to cleanse the inmates and their clothing, i.e., to free them from dirt and disease-carrying parasites. But this necessarily included a disinfection or disinfestation installation. The expansion of the crematoria was not however completed because work had already begun in the meantime on the central sauna which was better suited for this purpose. The documents cited here nevertheless prove a temporary intent on the part of the Central Construction Office to perform cremation, inmate cleaning and the disinfestation of clothing in the same building.

Now I think that it is not irrelevant to note here that in this project the water heating system for the showers was connected to the garbage incinerator and not to the crematorium oven, as for example in the five-muffle oven of the Lublin KL. In my opinion, the reason for that decision was the fact that the crematorium ovens did not ensure a continuity of use to be able to provide sufficient hot water throughout the entire day; in other

²¹¹ RGVA, 502-1-336 (page number illegible).

²¹² RGVA, 502-1-312, p. 8.

²¹³ RGVA, 502-1-316, p. 431, "Zweitschrift" in 502-1-323, p. 137.

²¹⁴ Inventory of the delivery negotiations relating to the "Desinfektions- und Entwesungsanlage" (Zentralsauna) of 22. January 1944. RGVA, 502-1-335, p. 3.

words, the crematorium ovens were not used enough to ensure efficient operation of the water heating system.

That the VEDAG-Invoice^[213] indeed refers to the hot-air disinfecting chambers installed in the Zentralsauna, is definitely proven by a VEDAG single invoice which has the same date and the same contents as the first invoice noted above, but it refers to the 'BW 32 = disinfection facility,' that is to say, precisely in the Zentralsauna.^[215] But for what reason does the invoice have as its subject: 'Auschwitz-crematorium'? This heading has an obvious relationship to the aforesaid Topf 'itemization' of April 13, 1943, concerning '2 Topf disinfection heaters for Crema II' which were then installed in the Zentralsauna. In any case, the two documents establish the correlation crematorium–disinfection and portray the expression of a plan or at least of a intention by the Central Construction Office to combine cremation and disinfection within the same edifice."

Since, as shown in chapter 5.2.2., the installation of hygiene centers with showers, disinfection, undressing and dressing rooms and adjacent crematoria is not at all unusual, the "traces" adduced by Pressac and van Pelt may be seen to have been incorrectly interpreted.

5.4.1.2.3. "Gas-tight Doors" for Crematorium II

Fact 1: Morgue 1 in Crematorium II was equipped with gas-tight doors with a peephole.²¹⁶

Fact 2: An initially planned double door opening to the inside of Morgue 1 was replaced by a double door opening to the outside.²¹⁷

Incorrect conclusion 1: Morgue 1 in Crematorium II was converted into a homicidal "gas chamber," equipped with gas-tight doors sporting peepholes to observe the victims' demise.²¹⁸

Incorrect conclusion 2: Doors opening to the inside of Morgue 1 would have been blocked by gassing victims piling up in front of it so that the doors could not have been opened. Realizing this, the SS changed the doors to open to the outside.

Correct conclusions 1: Even if a peephole was not entirely necessary for a disinfection chamber, it has nevertheless been proved that the disinfection chamber doors installed in Auschwitz were also equipped with exactly such peepholes, as shown in the photograph reproduced

²¹⁵ *RGVA*, 502-1-316, p. 430.

²¹⁶ J.-C. Pressac, *op. cit.* (note 72), pp. 434-436.

²¹⁷ *Ibid.*, pp. 285, 302.

²¹⁸ See also Pressac footnote above; see also Gray, judgment, *op. cit.* (note 71), §13.84; Richard J. Green, "Report of Richard J. Green," introduced in evidence during the libel case before the Queen's Bench Division, Royal Courts of Justice, Strand, London, David John Cawdell Irving vs. (1) Penguin Books Limited, (2) Deborah E. Lipstadt, ref. 1996 I. No. 1113, 2001, p. 6; www.holocaust-history.org/irving-david/rudolf/affweb.pdf.

here (Fig. 32).²¹⁹ Peepholes were in fact required for all disinfestation doors, because anyone entering a disinfestation chamber had to be observed from the outside in order that, in case of an accident, help could be provided immediately.²²⁰

One document indicates that gas-tight doors measuring 100 cm × 192 cm were ordered for Morgue 1 (the “gas chamber”) of Crematoria II and III.²²¹ But since the same kind of door was also ordered for the inmate sauna in building BW5a (for hygienic and health reasons the inmates had a sauna, see Fig. 19), this merely shows that gas-tight doors do not prove any homicidal intent *per se*.²²²

On the delivery plan, *i.e.*, the final plan for Crematorium II, the size of the doors is drawn in as 190 cm × 170 cm, 30 cm less wide than on older plans. Hence this gas-tight door would not have fit.²²³ Based on the ruins, it must be possible even today, to establish whether the door was possibly walled in to make it even narrower and whether there are any traces of door frames. Excavations would be necessary to determine this.

The engineers Nowak and Rademacher



Fig. 32: Wooden disinfestation chamber door at Auschwitz, rendered provisionally gas-tight with peephole and metal protection grid. This is what the gas-tight doors for the homicidal “gas chambers” are supposed to have looked like. Note the extremely flimsy lock.

²¹⁹ J.-C. Pressac, *op. cit.* (note 72), pp. 46-50, here p. 49.

²²⁰ C. Mattogno “Auschwitz: ‘Gas Testers’ and Gas Residue Test Kits,” *The Revisionist*, 2(2) (2004), pp. 150-155, here p. 152.

²²¹ *Ibid.*, p. 436. In the inventory list on p. 430, a handwritten entry mentioning a gas-tight door only appears in Crematorium II.

²²² RGVA, 502-1-328, p. 70: “Herstellung von 2 Stck. Gasdichte Türen 100/200 für die Sauna”.

²²³ *Ibid.*, p. 311, blueprint of March 20, 1943; older plans: pp. 227, 308, 312, 322.

have shown that the “gas-tight” doors manufactured at Auschwitz by inmates from wooden planks could not have been gas-tight in a technical sense. The planks did not close hermetically, the fittings were simply fastened through the wood by means of bolts, and the seals consisted of felt strips.²²⁴

One has to consider that a hypothetical homicidal “gas chamber” door would have to open outwards – a door opening inwards would be blocked by inmate bodies lying in front of the door. Such doors would require an especially stable arrangement, because the locks and hinges would have to be capable of resisting the pressure of hundreds of panicking people. The pressure exerted by such masses of people becomes

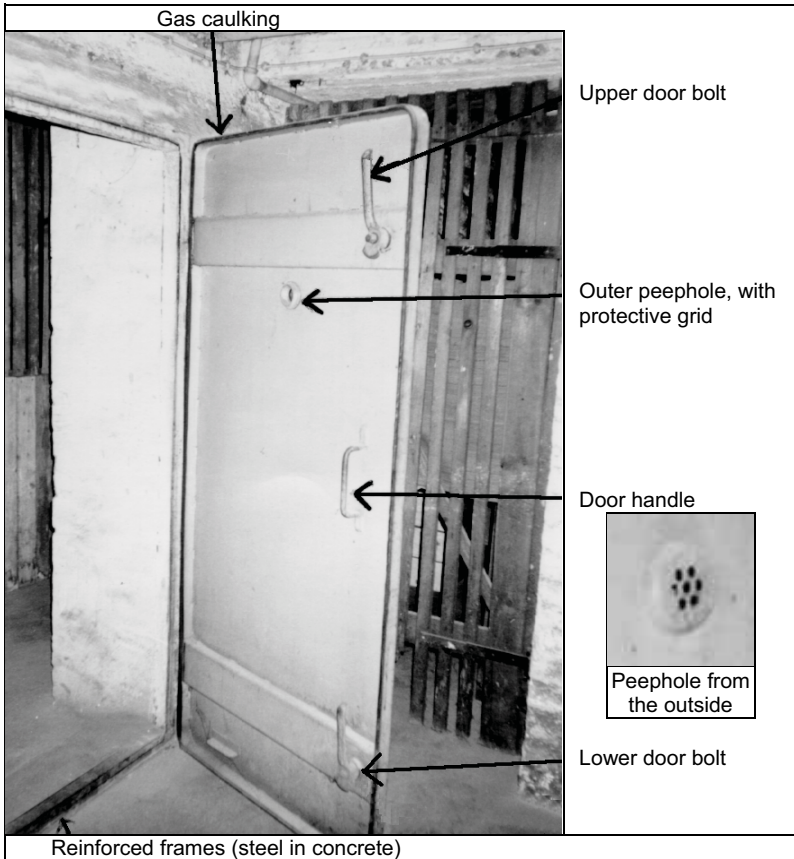

Fig. 33: German air-raid shelter door from 1939 in the cellar of a private house in Karlsruhe © Photo: R. Faurisson, 1991

²²⁴ H.J. Nowak, W. Rademacher, “‘Gasdichte’ Türen in Auschwitz,” *VffG* 2(4) (1998), pp. 248-261; Engl.: “‘Gas-Tight’ Doors in Auschwitz,” in: G. Rudolf (ed.), *op. cit.* (note 24), pp. 324-336.

apparent when one recalls the photographs of panicky spectators at football/soccer matches. Separating fences and partitions between individual spectator blocks are commonly trampled down like mere blades of grass in such situations. In any case, a simple wooden door, rendered provisionally gas-tight, as has been found in Auschwitz, a photograph of which is reproduced by Pressac in his book (see Fig. 32),²²⁵ could never have resisted such pressure.

The camp administration could actually have ordered solid, technically gas-tight steel doors (air-raid shelter doors, Fig. 33) since they were offered such doors, but it can be proven that they did not order them. One must assume that they had no serious need for them.²²⁴

In this context, a comparison of the flimsy wooden doors as found in Auschwitz (used for delousing purposes only) with technically gastight, massive iron doors as used for executions in U.S. homicidal gas chambers is revealing, compare Fig. 32 with Fig. 5 (page 24).

The installation of a door with felt seals in Crematorium II may have been temporarily considered either in connection with the temporarily considered expansion into a hygiene center or because it was desired to use the only solid reinforced concrete cellar in Birkenau camp as an air-raid shelter, as remarked by senior engineer Schreiber. Several eyewitness testimonies suggest indeed that this cellar was actually used as an air-raid shelter for inmates.²²⁶ This would also explain other more minor “traces” which cannot be discussed here. Samuel Crowell has shown in several articles the extent to which the SS actually built air-raid shelter installations not only for themselves but also for the camp inmates.²²⁷

²²⁵ J.-C. Pressac, *op. cit.* (note 72), pp. 46-49, 425-428, 486, 500.

²²⁶ Miklos Nyzsli's book *Auschwitz: A Doctor's Eyewitness Account*, Arcade Publishing, New York 1993, alleges, on p. 128, that the inmates took refuge in the gas chamber during air raids. Martin Gilbert's *Auschwitz and the Allies* (Henry Holt & Co., New York 1981), p. 309, contains the testimony of a female survivor, according to which she, together with many other female arriving inmates, was led to a darkened room to remain there during an air raid. What is most interesting about this testimony is the description of the manner in which some of the women became hysterical during the air raid and believed that they were inhaling poison gas. Another conclusion which could be drawn from this testimony is that the SS were concerned with protecting their inmates from air raids, and that there must have existed several such air raid shelters at Birkenau, which must have been gas-tight, that however remained entirely unnoticed and unstudied (from: S. Crowell, “Technik und Arbeitsweise deutscher Gasschutzbunker im Zweiten Weltkrieg,” *VffG* 1(4) (1997), p. 242, fn. 4; Engl.: “Technique and Operation of German Anti-Gas Shelters in WWII: A Refutation of J.C. Pressac's Criminal Traces,” www.codoh.com/incon/incompressac.html. Another survivor reports that the inmates were regularly led into an air raid shelter during Allied air raids in 1944: Colin Rushton, *Spectator in Hell. A British Soldier's Extraordinary Story*, Pharaoh Press, Springhill (Berkshire) 1998.

²²⁷ Samuel Crowell, *ibid.*; see also “The Gas Chamber of Sherlock Holmes: An Attempt at a Literary Analysis of the Holocaust Gassing Claim,” www.codoh.com/incon/inconshr123.html; “Comments on Mattogno's critique of the bomb shelter thesis,” www.codoh.com/incon/inconscrmtgno.html; “Bombenschutzeinrichtungen in Birkenau: Eine

Correct conclusions 2: The change in orientation of the doors was probably caused by the design of this morgue's ventilation system. Since the air inlet of this system had a higher resistance than the outlet (see next chapter), a considerable subpressure was caused in Morgue 1, constantly sucking air in from the rest of the building. This is a desired effect for a morgue where many corpses had to be stored, so that unpleasant smells would not reach other parts of the building. A double door opening to the side with a lower pressure (inside Morgue 1) would open automatically, whereas a door opening to the side of higher pressure closes automatically.

5.4.1.2.4. Ventilation Installations

Fact: All rooms in Crematoria II and III were equipped with efficient ventilation installations.²²⁸

Incorrect conclusion: Morgues 1 of Crematoria II and III were converted into homicidal "gas chambers" equipped with installations for the intended purpose of extracting poison gases.²²⁹

Correct conclusion: It is in fact inconceivable that a large morgue without windows and with only one door filled with innumerable bodies of the victims of epidemic disease would *not* be equipped with a ventilation system. The capacity of the ventilation system, however, proves that these installations were designed for typical morgues.²³⁰ The capacity of the blowers can be gleaned from invoices sent to the Central Construction Office by the Topf corporation after installation of the systems.²³¹ According to this, both morgues #1, *i.e.*, the alleged "gas chambers" (in the invoice designated as the "B-room"), were each equipped with a 4,800 m³/h intake and outlet blower,²³² while for the

Neubewertung," *VffG* 4(3&4) (2000), pp. 284-330; Engl. "Bomb Shelters in Birkenau: A Reappraisal," www.codoh.com/incon/inconbsinbirk.html; upcoming: Samuel Crowell, *The Gas Chamber of Sherlock Holmes*, Nine-Banded Book, Charleston, WV, in press (2011).

²²⁸ The ventilation ducts of Morgue 1 are visible in the plans published by J.-C. Pressac, *op. cit.* (note 72), pp. 224, 289; chapter on the ventilation installations of Crematoria II and III: *ibid.*, pp. 355ff.; engine power of the ventilation installations for all rooms in Crematoria II and III: *ibid.*, p. 374 and 377; size of the ventilation outlets: *ibid.*, p. 234; Fig. of an outlet cover in the ventilation outlets.

²²⁹ For Pressac see footnote above; a similar opinion has been expressed by van Pelt, *Pelt Report*, *op. cit.* (note 71), p. 208, as well as by Judge Gray in the Irving vs. Lipstadt trial, *op. cit.* (note 71), §7.62.

²³⁰ See also, in this regard, C. Mattogno, in: G. Rudolf (ed.), *op. cit.* (note 96), pp. 153-155. The following remarks are closely patterned after Mattogno; for further details see there.

²³¹ Invoice no. 729 dated May 27, 1943. *APMO*, D-Z/Bau, nr. inw. 1967, pp. 246f.; *ibid.*, 231f.: invoice no. 171 dated 22. February 1943 for Crematorium II.

²³² The engines had a nominal output of 2 HP (approximately 1.5 KW). The output data relate to a back-pressure of 40 mm water column. The increment calculations for estimating the ventilation shaft resistances in Crematoria II & III according to engineering handbooks have shown

“L-room” (the so-called “undressing room”) only one outlet blower was installed with a capacity of 10,000 m³/h.²³³

When considering the volume of the two morgues (Morgue 1: 504 m³; Morgue 2: 900 m³), this results in (4,800÷504 =) approximately 9.5 air exchanges per hour for the alleged, planned “gas chambers,” and in (10,000÷900 =) approximately 11 air exchanges per hour for the undressing rooms. How come the SS assumed that the “gas chambers” would need less ventilation than the undressing rooms, or even less than the dissecting rooms, laying out rooms and wash rooms, which had an even greater capacity of approximately 13¹/₃ air exchanges per hour?

Wilhelm Heepke’s classic work on the construction of crematoria states that a morgue requires a minimum of 5 air exchanges per hour and 10 during intensive use.²³⁴ Thus it is clear that the ventilation installations provided for the morgues were designed, in terms of orders of magnitude, for morgues in intensive use or for morgues containing the bodies of epidemic disease victims. For comparison: professionally designed Zyklon B disinfestation chambers with circulating air systems were equipped with 72 air exchanges per hour.²³⁵ Furthermore, it should be mentioned that the *original* plans for a new crematorium in the main camp from 1941 – a time when even Pressac admits that the SS had no criminal intentions – provided for 17(!) air exchanges per hour for the dissecting room(!) and the morgues.²³⁶ This exchange rate is considerably higher than what was later realized for all rooms of Crematoria II and III, including the alleged “gas chambers.” Thus, on the way from beneficial planning to (allegedly sinister) construction, the air exchange rates had been drastically *reduced* (probably in order to reduce costs). Does anybody seriously believe that the SS would have lowered the ventilation capacity when changing the designation of a morgue from a beneficial use to a homicidal “gas chamber,” instead of increasing it?

that the back pressure to be expected would probably have been higher (in the region of 50-60 mm water columns), due, particularly, to the primitive lids with many small holes covering the ventilation slit. Two blowers were probably used for this reason. Personal communication from Hans Lamker, a certified engineer.

²³³ J.-C. Pressac gives the output of these blowers at 8,000 m³/h, but without proving it (together with Robert van Pelt in: Yisrael Gutman, Michael Berenbaum (ed.), *Anatomy of the Auschwitz Death Camp*, Indiana University Press, Bloomington 1994, pp. 210, 232). Perhaps he simply crudely added the output of the two blowers together, which is impermissible, since the blowers did not work in parallel, but in series (behind each other).

²³⁴ W. Heepke, *Die Leichenverbrennungs-Anstalten*, C. Marhold, Halle 1905, p. 104.

²³⁵ Gerhard Peters, Emil Wüstiger, “Sach-Entlausung in Blausäure-Kammern,” *Zeitschrift für hygienische Zoologie und Schädlingsbekämpfung*, 10/11 (1940), pp. 191-196, here p. 195.

²³⁶ J.-C. Pressac, *Les crématoires d'Auschwitz*, *op. cit.* (note 95) p. 18.

This is thus the final refutation of any argument on the alleged criminal characteristics of the ventilation installations in these crematoria.

5.4.1.2.5. Pre-heated Morgues

Fact: The morgues of Crematoria II and III were never heated, although a heating system was temporarily considered; water pipes in Morgue 1 were removed.²³⁷

Incorrect conclusion: Morgues need no heating for normal operational functioning. Crematoria II and III were converted into homicidal “gas chambers,” (intended to be) equipped with a heating system so that “the gas would work more rapidly.” It was necessary to eliminate the plumbing system in the morgue because panic-stricken inmates would have damaged the pipes.²³⁸

Correct conclusion: According to expert literature, morgues do indeed need some kind of heating equipment, because corpses must be protected from the effects of frost and freezing temperatures in winter.²³⁹ Hence, under normal operation, morgues would have been equipped with heating devices, but the initial plans to equip the morgues in Auschwitz with heaters were cancelled,²⁴⁰ rendering the argument obsolete. Regarding the removal of the water pipes, a “non-criminal” explanation follows logically: Since no heating was ever installed in these morgues, there was a danger that the water pipes would have burst in freezing temperatures due to the lack of any heating (if the pipes could not be completely drained). In order to prevent burst pipes and a subsequent flooding of the morgues, the pipes were removed.

5.4.1.2.6. “Cremation with Simultaneous Special Treatment”

Fact: With regards to the “Electrical supply and installation of the concentration camp and prisoner of war camp” the documentary note (“*Aktenvermerk*”) of the Auschwitz Central Construction Office of January 29, 1943, states:²⁴¹

²³⁷ Pre-heating: J.-C. Pressac, *op. cit.* (note 72), pp. 221, 223. Demolition of the water pipes: *ibid.*, p. 286; for further details in this discussion, which is just as fruitless, since they are based on the “criminal traces” dreamed up by Pressac; see in general C. Mattogno, *op. cit.* (note 76).

²³⁸ See also the above footnotes referring to Pressac, in particular, relating to the water pipes; a similar opinion expressed by van Pelt, *Pelt Report, op. cit.* (note 71), p. 296, as well as by Judge Gray in the Irving vs. Lipstadt trial, *op. cit.* (note 71), §7.68.

²³⁹ E. Neufert, *op. cit.* (note 182).

²⁴⁰ J.-C. Pressac, *op. cit.* (note 72), p. 230. The waste heat of the forced draught blowers was to be used, but since these burned out and were removed, the entire pre-heating project for Morgue 1 was cancelled.

²⁴¹ *RGVA* 502-1-26-21, Jan. 29, 1943.

“This putting into operation [of Crematorium II] can however only extend to restricted use of the available machines (in which case cremation with simultaneous special treatment [original: “Sonderbehandlung“] will be made possible) since the [electrical] supply leading to the crematorium is too weak for its output consumption.”

Incorrect conclusion: Since the “special treatment” mentioned apparently required electricity and because the homicidal “gas chamber” possessed an electrical ventilation, R.J. van Pelt concludes that “*Sonderbehandlung*” referred to homicidal gassings, which was made possible by operating the ventilation despite a reduced power supply.²⁴²

Correct conclusion: First, it is not apparent from this document whether or not electricity is required for “special treatment.” Furthermore, on January 29, 1943, the ventilation installation for the morgue had not yet even been delivered, let alone installed and put into operation. Commencement of construction was not anticipated before February 10.²⁴³ Installation was only charged to the account on February 22, 1943.²⁴⁴ Therefore, the “available machines” on January 29, 1943, did not include the ventilation system. Actually, the concept “special treatment” in this connection has no “criminal” significance at all, as W. Stromberger¹⁰⁹ and recently C. Mattogno have pointed out:²⁴⁵

“By considering the historical context – a typhus epidemic increase so dangerous in 1942 as to induce [...] Major General of the Waffen SS Glücks to command on February 8, 1943, the complete quarantine of the camp^[246] – the meaning of the term ‘special treatment’ in the memorandum of January 29, 1943, could only be an extension of its hygienic-sanitary meaning which emerges from other documents.²⁴⁷ That is, from the hygienic-sanitary point of view, the ‘existing machines’ would have guaranteed proper cremation with limited capacity.

This is confirmed by a document going back a few weeks. On January 13, 1943, Bischoff wrote a letter to the firm Deutsche Ausrüstungswerke in Auschwitz with the subject ‘Fulfillment of carpentry jobs for the building planning room.’ In this document, Bischoff complained about the delay in receiving doors ‘for Crematorium I in the KGL,’ explaining in detail.²⁴⁸

²⁴² Robert van Pelt, Deborah Dwork, *op. cit.* (note 97), p. 330.

²⁴³ Memorandum from Kirschneck dated 29 January 1943. *APMO*, BW 30/34, p. 105.

²⁴⁴ Topf, invoice no. 171 dated 22. February 1943 relating to the installation for the ventilation of Crematorium II. *RGVA*, 502-1-327, pp. 25-25a. See also C. Mattogno, *op. cit.* (note 230), pp. 136-139.

²⁴⁵ See also C. Mattogno, “Architektonische Stümpereien...,” *op. cit.* (note 97), p. 31.

²⁴⁶ *APMO*, Standort-Befehl, D-AuI-1, p. 46.

²⁴⁷ For this, see Carlo Mattogno, *Special Treatment in Auschwitz. Genesis and Meaning of a Term*, Theses & Dissertations Press, Chicago 2004.

²⁴⁸ *APMO*, BW 30/34, p. 78.

‘Above all, the ordered doors of Bftgb. No. 17010/42/Ky/Pa of order letter dated 26.10.42 for Crematorium I of the concentration camp are urgently needed for carrying out special measures.’

The expression ‘carrying out special measures’ had no criminal significance at all. On the contrary, it denoted the construction of hygienic-sanitary installations, including the hospital for the prisoners (Häftlingslazarett) projected for the BIII sector of Birkenau. Therefore, if the crematorium was made for ‘carrying out special measures,’ it means that it was a part of these installations and its hygienic-sanitary function was exclusively the cremation of dead bodies of deceased camp prisoners.”

5.4.1.2.7. “Gas Testers” and “Indicator Devices for HCN Residues”

Fact 1: There is a telegram of February 26, 1943, by means of which heating technician Jährling of the Topf & Söhne oven construction firm orders “10 gas testers” for Crematorium II.

Fact 2: There is a letter from the Topf corporation of March 2, 1943, which, referring to the above telegram, mentions “Anzeigegeräte für Blausäure-Reste” (indicator devices for HCN residues).

Incorrect conclusion: The SS ordered the indicator devices in order to verify whether the ventilation of the “gas chamber” was successful after completion of mass murder with hydrogen cyanide in Crematorium II.²⁴⁹

Correct conclusion: According to the technical literature, “gas testers” are flue gas analyzers intended to determine the exhaust gas composition of oven gases.²⁵⁰ Such devices were standard equipment in crematoria. That the above-mentioned order referred to such devices is clear from the fact that they were ordered by a heating technician from an oven construction firm. The letter in reply from the Topf corporation dated March 2, 1943, stating that one must first find out who marketed these devices, has been revealed on several occasions to be an absurdity.²⁵¹

- According to contemporary literature, devices for the detection of HCN residues were called “Blausäurerestnachweisgeräte” (HCN residue detection devices) or “Gasrestnachweisgeräte für Zyklon” (Gas residue detection devices for Zyklon).¹³² Since the Topf &

²⁴⁹ See the two footnotes above, with relation to Pressac; van Pelt, *Pelt Report*, *op. cit.* (note 71), pp. 200, 254.

²⁵⁰ Akademischer Verein Hütte (ed.), *Hütte*, Ernst und Sohn, Berlin 27/1942, p. 1087

²⁵¹ Werner Rademacher (=Walter Lüftl), “The Case of Walter Lüftl,” in: G. Rudolf (ed.), *op. cit.* (note 24), pp. 78ff.; C. Mattogno, “The ‘Gas Testers’ of Auschwitz,” *The Revisionist* 2(2) (2004), pp. 140-154.

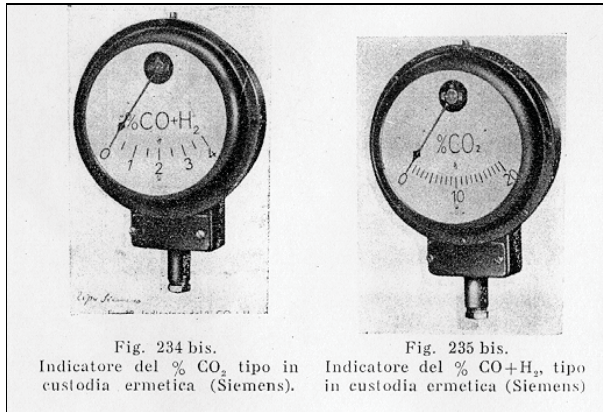

Fig. 34: Photograph of two indicator devices from the Siemens corporation for the CO+H₂ and CO₂ content, respectively, in %. Component of a gas tester.²⁵²

Söhne corporation, according to the letter, had already received information on the possibility of procurement of such devices from three firms, the correct name of these devices must in the meantime have penetrated even to Topf & Söhne.

- Furthermore, these detection devices are based on a wet chemical method which possessed no “indicator” and could not, therefore, be designated as indicator devices. On the other hand, the gas testers mentioned in the telegram had a physico-chemical sensor connected to a dial (see Fig. 34).
- According to contemporary prescriptions, testing with HCN residue testing devices was obligatory in every disinfection action using hydrogen cyanide in order to test whether the ventilation of a fumigated room had been successful before it could be entered without a gas mask. Since disinfection had been performed on a large scale in Birkenau since 1941, it is categorically impossible that no one should have concerned himself with the possibility of ordering such devices before early 1943!
- Since the creation of Birkenau camp in 1941, the SS garrison doctor for Auschwitz camp was responsible, among other things, for the ordering, administration, and use of Zyklon B and all materials for its handling (disinfection installations, gas masks, HCN residue detection devices, etc.). He therefore had three years experience in this business. Why then should the Central Construction

²⁵² Alberto Cantagalli, *Nozioni teorico-pratiche per i conduttori di caldaie e generatori di vapore*, G. Lavagnolo Editore, Turin 1940, p. 308; taken from C. Mattogno, *op. cit.* (note 251), p. 19.



Fig. 35: Photograph of Crematorium II of Birkenau taken in February 1943.²⁵⁶

Office, which was not competent in this matter, in addition to being unauthorized, have issued the order for the procurement of HCN residue detection devices in 1943?

- In addition to crematorium ovens, the Topf corporation also produced hot air disinfection ovens as well as silo fumigation installations which were, however, not operated with HCN.²⁵³ Why then should the heating technician Jährling, a civilian engineer, order devices, of which he had no knowledge, from a firm, which obviously did not even know the supplier of the devices, when the health service of Auschwitz camp had already been regularly supplied with these devices by the Tesch und Stabenow corporations for two years and therefore knew the supplier? There was very probably a supply of them in storage at the camp.

It is therefore the conviction of W. Rademacher, C. Mattogno and myself that this reply from the Topf corporation is a forgery, in which a term such as “Anzeigergeräte für Rauchgasanalyse” was perhaps replaced by the term “Anzeigergeräte für Blausäure-Reste” (Indicator Device for Smoke Analysis by Indicator Device for HCN Residues).

²⁵³ Hydrogen cyanide would form poisonous residues with moist food. The gases Areginal and Cartox were used; see also G. Kunike, *Das ABC der Vorrats- und Hausschädlinge und ihre Bekämpfung*, Theodor Weicher, Berlin 1941, pp. 53f.

5.4.1.2.8. Zyklon B Introduction Holes and Columns

Fact 1: There are eyewitness testimonies claiming that there were three or four square holes measuring 70 cm in the roofs of both morgues 1 of Crematoria II and III. According to some witnesses, columns fabricated of mesh metal ran from the floor of the morgues through the holes in the ceiling and protruded over the roof. Zyklon B is alleged to have been thrown into these columns for the purpose of mass killings.²⁵⁴

Fact 2: There are two photographs showing objects on the roof (see further below).

Fact 3: There is a document mentioning “*Drahtnetzeinschiebevorrichtungen*” (wire mesh push-in devices).

Incorrect conclusion: The eyewitnesses are right.

Correct conclusion: Pressac reproduced a photo of Crematorium II showing square objects located on the roof of Morgue 1 (the fourth object obviously lies behind the cellar).²⁵⁵ The same photograph also appears in Danuta Czech’s book.²⁵⁶ It was taken in early February 1943, see Fig. 35, the decisive detail of which being magnified in Fig. 36. If these objects are really Zyklon B introduction holes, as Pressac believes, then one must assume that the objects are:

a) of equal size

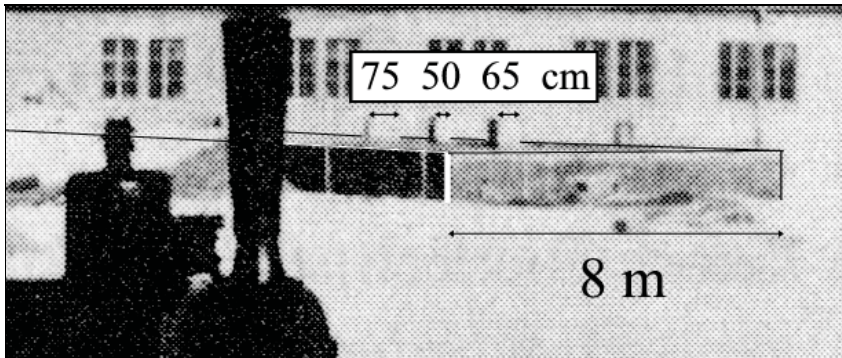

Fig. 36: Magnification of detail from Fig. 35 with outlines of the morgue and scale of measurements drawn in. The width of the three objects in Fig. 35 shows strong variation between ca. 50 and 75 cm. Furthermore, it is notable that the shady side of the first object, seen from the left, is considerably weaker than those of the others.

²⁵⁴ Henryk Tauber: J.-C. Pressac, *op. cit.* (note 72) p. 484; Filip Müller, *Sonderbehandlung*, Steinhausen, Munich 1979, p. 95; Charles Sigismund Bendel: E. Kogon *et al.*, *op. cit.* (note 46), p. 227; Michal Kula: E. Kogon *et al.*, *op. cit.* (note 46), p. 231; for a summary and critique of these and other witness accounts on these alleged openings and introduction devices, see G. Rudolf, *op. cit.* (note 73), pp. 34-37.

²⁵⁵ *Op. cit.* (note 72), Crematorium II, p. 340, taken ca. between Feb. 9 and 11, 1943.

²⁵⁶ D. Czech, *op. cit.* (note 94), p. 454.

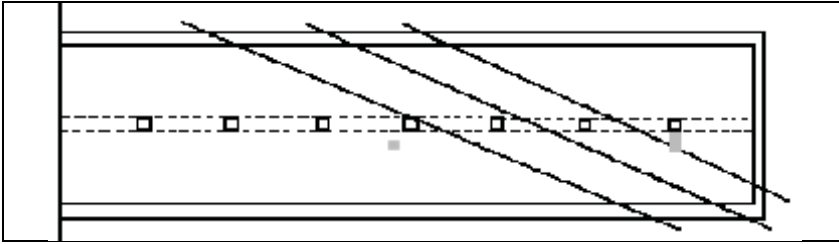

Fig. 37: Schematic drawing of a view onto Morgue 1 of Crematorium II. Longitudinally painted: the concrete longitudinal beam with the 7 supporting pillars. Drawn in as intersecting lines: base-lines, upon which the middle of the three objects located on the roof must have been located.²⁵⁷ Obviously, they were not evenly distributed along the roof. Gray rectangle: actual location of the two openings in existence today.

- b) regularly aligned
- c) regularly distributed along the roof
- d) nearly the same color and
- e) casting approximately the same shadows.

Fig. 36 points out the outlines of the cellar, indicating its width as well as the approximate width of the three objects. Despite the mediocre resolution of the photograph, it may be concluded that these objects are of unequal width, not evenly distributed over the roof, but stand, on the contrary, close together. It also seems peculiar that the shady side of the first object seen from the left, compared with those of the other two objects, is remarkably light in color. Fig. 37 shows the alignment of perspective, viewed from above, on which these objects can possibly be located.²⁵⁷ As none of the requirements set forth above is met, the argument that these objects are above-roof parts of Zyklon B introduction stacks must be abandoned.

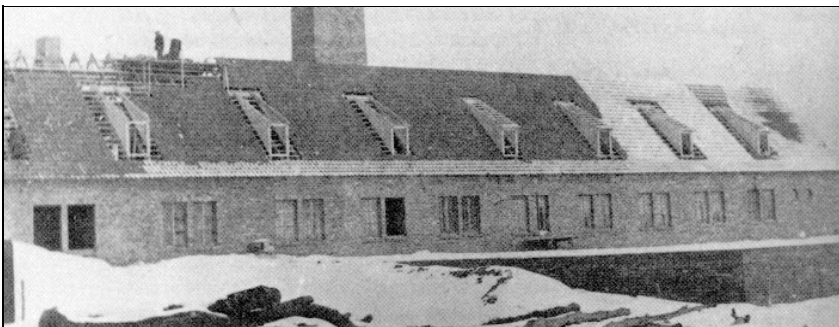

Fig. 38: Photograph of Crematorium II from Jan. 20, 1943, similar in perspective as Fig. 35, but without objects on the roof of Morgue 1.

²⁵⁷ Taken from Jean-Marie Boisdefeu, *La controvers sur l'extermination des Juifs par les Allemands*, volume 1, Vrij Historisch Onderzoek, Berchem 1994, p. 168.

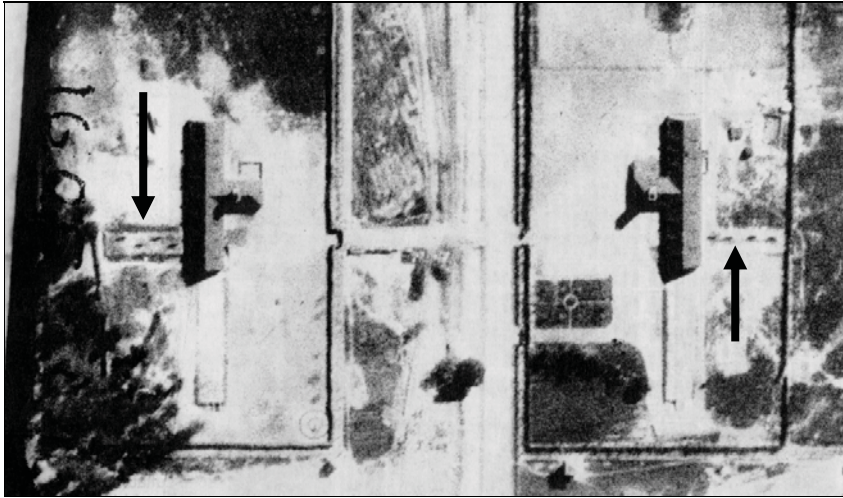

Fig. 39: Enlargement of Allied air photo RG 373 Can F 5367, exp. 3185 of Birkenau camp, taken on August 25, 1944. An interesting feature is the dark spots on Morgue 1 (“gas chambers”) of both crematoria (arrow), of which it is known today that there are no introduction stacks for Zyklon B.

It should be mentioned in passing that these objects are not to be seen in other photographs of the morgue, see Fig. 38 taken on January 20, 1943,²⁵⁸ as well as another photograph reproduced by Pressac and taken in the summer of 1943.²⁵⁹ It will therefore be necessary to find another explanation for the objects in the photograph taken in February 1943, such as, for example, that some sort of objects had been placed on the roof – perhaps in the course of constructing the building, undertakings which were obviously still underway – or *horribile dictu*, but less likely, that the picture has been retouched at a later date.

Fig. 39 shows an enlargement of an Allied air photo of Birkenau camp taken on August 25, 1944.²⁶⁰ Darkened areas (arrow) are clearly visible on the lateral wing, the roof of Morgue 1 (“the gas chamber”) of Crematorium II. A stereoscopic evaluation of this air photo shows that these darkened areas on Fig. 39 cannot have possessed any height.²⁶¹

²⁵⁸ From D. Czech, *op. cit.* (note 94), p. 398, and J.-C. Pressac, *op. cit.* (note 72), p. 335.

²⁵⁹ J.-C. Pressac, *op. cit.* (note 72), p. 341. Pressac, of course, alleges the existence of Zyklon B introduction apertures; in actual fact, however, nothing of the sort is to be seen.

²⁶⁰ Allied aerial photographs, National Archives Air Photo Library, Washington, D.C., RG 373 Can F 5367, exp. 3185, published by CIA employees D.A. Brugioni and R.G. Poirier, “*The Holocaust Revisited: A Retrospective analysis of the Auschwitz-Birkenau Extermination Complex*,” CIA, ST-79-10001, Washington, D.C., 1979; allegedly on their own, private, responsibility.

²⁶¹ R. Lenski, *op. cit.* (note 28), pp. 356ff., testimony of aerial photographic appraiser Kenneth R. Wilson, pp. 8 927-8 941e of the trial transcript; see also B. Kulaszka (ed.), *op. cit.* (note 28), pp. 353f. According to Wilson, the spots on the photos dated Sept. 13, 1944, cannot be seen.

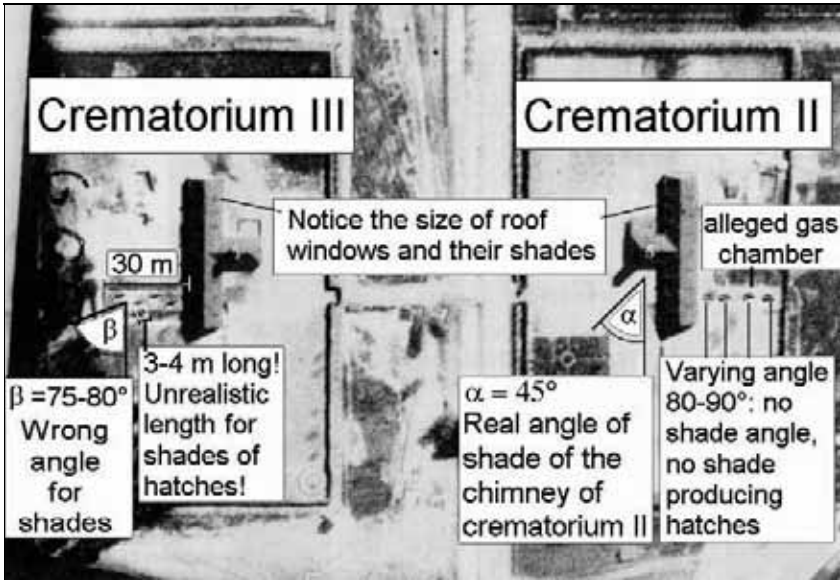

Fig. 40: Schematic drawing of the air photo in Fig. 39. It is immediately apparent that the spots on the roofs of morgues 1 cannot be introduction stacks: too large, too irregular, wrong direction for "shadows."

If the Zyklon B introduction stacks really possessed the dimensions of 70 cm ($2\frac{1}{3}$ ft) on each side as described by the eyewitnesses, this cannot be reconciled with the spots on the air photo, which are approximately 2 to 3 m² in area (20-23 ft²). It must be noted that the chimneys of the inmate barracks as well as the large crematorium chimneys are rich in contrast, symmetrical, and straight. The spots on Morgue 1 of both crematoria, by contrast, form an angle of approximately 75-80° (Crematorium III) or 80-90° (Crematorium II, irregular) to the arrangement of the main wing of Crematorium II (see schematic drawing Fig. 40). If these spots were objects of any kind, they would have to exhibit the same alignment as the shadows of the crematorium chimney of Crematorium II, the chimney of an inmate barracks, and other sharply conspicuous parts of the picture. The actual shadows, in contrast to the spots above, form a 45° angle to the main direction of Crematoria II and III (see Fig. 40).

We know that the chimney of Crematorium II was 15 m high.¹⁸⁶ It throws a shadow on the picture which is five times as long as the spots on the roof of Morgue 1 ("gas chamber") of Crematorium III (length of shadow of chimney: 20 m, that is, the angle of the sun was approximately 37°, length of the spots on Morgue 1 ("gas chamber") of Crematorium III: approximately 4 m). This means simply that the alleged

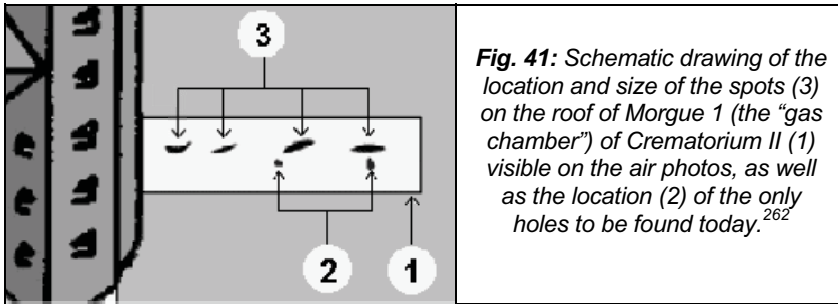

Fig. 41: Schematic drawing of the location and size of the spots (3) on the roof of Morgue 1 (the “gas chamber”) of Crematorium II (1) visible on the air photos, as well as the location (2) of the only holes to be found today.²⁶²

Zyklon B introduction stack must have projected 3 m above the roof of Morgue 1 (“gas chambers”) of Crematorium III in order to cast such long shadows, which may be ruled out as impossible.

Absence of spatial height, irregular shape, incorrect size (length and width), and wrong, irregular direction of the spots therefore prove definitively that these spots are neither the shadows of any objects, nor can they be the legendary Zyklon B introduction stacks. The irregular, vague nature of these spots, as well as the fact that they are missing on at least one air photo,²⁶³ gives rise to the conclusion that they are the re-touching of a forger, added at a later time. An expert study prepared in late 1992 by John Clive Ball, a professional air photo interpreter in Canada, has since proven that the air photos were faked while they were in the possession of the CIA – surprise, surprise!²⁶⁴

As a result of the long-lasting wrong interpretation of these spots on this air photo, the otherwise unfounded allegation was made that the alleged Zyklon B introduction stacks were aligned linearly on the middle of the roof in case of Morgue 1 (“gas chamber”) of Crematorium II, and aligned alternating to the left and to the right of the middle of the roof in case of Morgue 1 of Crematorium III, according to the location of the spots on this air photo. The alternating alignment, however, would contradict the argument that the Zyklon B introduction columns were aligned behind the concrete support pillars in order to conceal them so that the entering victims would not become suspicious. As a

²⁶² Figure 41 was taken from the Air Photo Evidence website (airphoto.com/altered/altered.html) with John C. Ball’s kind permission.

²⁶³ J. Ball, *Air Photo Evidence*, Ball Resource Service Ltd., Delta, B.C., Canada 1992, p. 48, Morgue 1 of Crematorium II, photograph dated 13 September 1944, RG 373 Can B 8413, exp. 6V2.

²⁶⁴ The manipulations on this picture are overly plentiful, such as, for example, a drawing of a group of inmates accidentally marching over the roof of a barracks! See also J.C. Ball, *ibid.*, p. 42; idem, “Air Photo Evidence” in: G. Rudolf (ed.), *op. cit.* (note 24), pp. 269-282. On the alleged original photographs, it may furthermore be seen that the spots on morgues 1 of both crematoria (II + III) are pointing in different directions; private communication by J.C. Ball.

matter of fact, no introduction column could have been hidden behind a concrete pillar, because this would have necessitated the opening of a hole not only through the reinforced concrete roof, but also through the massive longitudinal support beam, see Fig. 28, which would have compromised the stability of the entire morgue. Hence, an alignment to the left and/or right of the support pillars would have been unavoidable.

After the building was destroyed towards the end of the war – by whom does not matter – one occasionally encounters the attitude that the remaining ruins are fakes, and that the original installations have disappeared without a trace. This would mean that the Poles rebuilt the crematoria true to the original for many millions of zlotys after the war, only in order to blow them up. A grotesque idea. Thus the author of the present book was rejected as an expert witness by a court on December 6, 1991, and May 5, 1992, on the grounds that his research on the “gas chambers” was fully irrelevant since, as it was allegedly well known, the structures in Auschwitz were only fakes, the authentic “gas chambers” having disappeared without a trace.²⁶⁵

Such allegations are, of course, absurd, and only testify to the technical incompetence of the judges entrusted with these matters. It is a shame that such individuals are given the power to decide the fate of

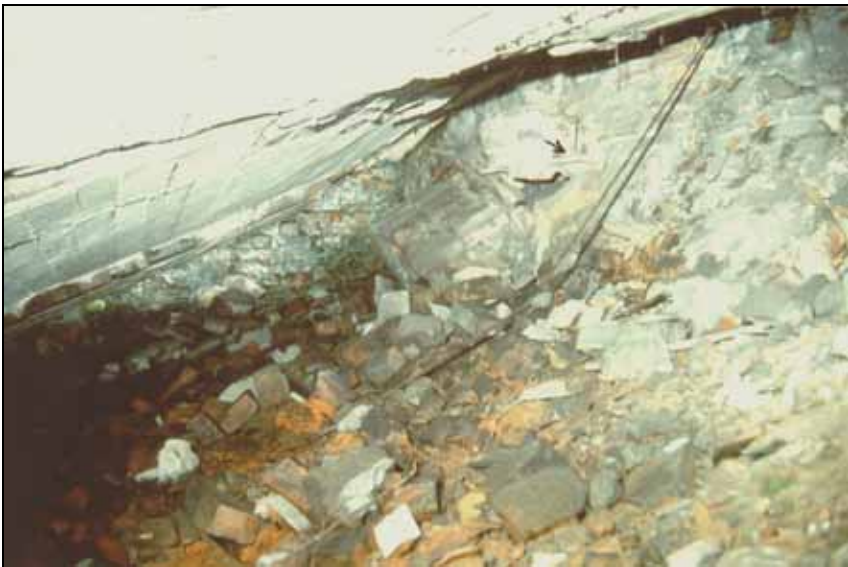

Fig. 42: Interior photograph taken from the ruins of Morgue 1 (“gas chamber”) of Crematorium II. The arrow points to the sample taking location (see chapter 8.3.3).

²⁶⁵ County Court Munich, ref. 451 Cs 112 Js 3326/90 and ref. 432 Cs 113 Js 3619/90.

others in these disputes.²⁶⁶

The roofs of Morgue 1 (“gas chambers”) of both crematoria today are broken in pieces and have collapsed, but the ceiling of Morgue 1 (“gas chamber”) of Crematorium II is still relatively intact. The next to the last of the seven pillars of Morgue 1 (“gas chamber”) of Crematorium II, seen from the south, still bears a piece of the ceiling. There, one can still climb down into the interior of the cellar through a hole in the ceiling (Fig. 43, p. 110) (see also Figs. 42 and 44), in which the ground water stands on the floor even in summer during a fairly lengthy dry season. Large parts of the masonry work and concrete ceiling accessible there are in original condition, protected from wind and weather. There are no visible signs of erosion or corrosion. In his book, Pressac shows illustrations of the circular, intact ventilation pipe openings through the ceiling of Morgue 2 of Crematorium II as well as through the concrete ceiling of the oven room of Crematorium III.²⁶⁷

Figs. 48-53 (p. 116) show the five openings in the ceiling of the



Fig. 43: Alleged Zyklon B introduction hole in the ceiling of Morgue 1 (“gas chamber”) of Crematorium II, entry to the still passable part of the cellar.

²⁶⁶ See, in this regard, the letter from the semi-official German Institut für Zeitgeschichte, in which, with relation to the Auschwitz State Museum, the reconstruction of the installations in Crematorium I is described and the condition of the original ruins of the crematoria in Birkenau are briefly mentioned: H. Auerbach, Institut für Zeitgeschichte, Munich, letter dated March 20, 1992.

²⁶⁷ J.-C. Pressac, *op. cit.* (note 72), pp. 365f.

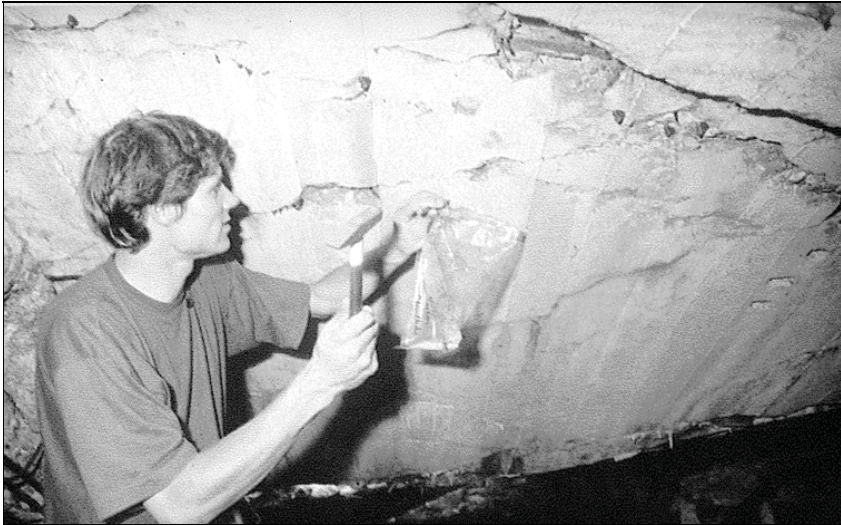

Fig. 44: Ceiling of Morgue 1 ("gas chamber") of Crematorium II. Sample taking location of samples 1 and 2.

oven room of Crematorium III as of December 1991. They were used to withdraw radiant heat from the crematorium ovens. The ceiling collapsed during the demolition of the oven room, and most of the five holes were damaged to some degree during the process.

If the Zyklon B introduction holes described by eyewitnesses really existed, with the wire mesh columns installed inside them, then what else is to be expected?

According to eyewitness Henryk Tauber, the victims would have demolished all the equipment in this room:²⁶⁸

"The people going to be gassed and those in the gas chamber damaged the electrical installations, tearing the cables out and damaging the ventilation equipment."

1. Several hundred people, locked into a cellar with a very small surface area, anticipating death, would panic and attempt to escape, damaging everything that stood in their way. So what would the victims locked into the cellar have done to the wire mesh columns described by the eyewitnesses? If these columns actually existed, their outer framework would have to have been of solid steel, but certainly not of fragile wire mesh construction.

2. These columns would, in addition, have had to have been solidly anchored in the concrete ceiling, the floor, and the concrete pillars. But since solid anchoring dowels did not yet exist at that time, hoop irons

²⁶⁸ *Ibid.*, pp. 483f.; *Pelt Report*, *op. cit.* (note 71), p. 106.

would have been cast into the concrete during the construction of the cellar, spread out to a “dovetail” inside the concrete.²⁶⁹ If carried out after completion of the building, holes would have been chiseled into the concrete, and the hoop irons would have been cast in cement filling these holes, see Fig. 46 (p. 113). In both cases, a removal of such cast-in hoop irons would have been impossible. All one could do is cut them off with a saw or a welding torch.²⁷⁰ Hence, if any introduction device was ever installed in these morgues, traces of such hoop irons must still be present.

3. Furthermore, the steel reinforcement rods in the reinforced concrete would have to run wreath-like around the hole, and would be capable of verification by means of induction devices, even today.

4. Since, in addition, the morgues’ roofs were covered with a layer of soil approximately one half meter thick, the entire construction would have to be protected against the intrusion of soil and rain water, and in so doing it would have been indispensable to raise the edges of the holes above the surface of the roof like miniature chimneys.

Nothing of the kind can be found on the roof of Morgue 1 of Crema-



Fig. 45: Alleged Zyklon B introduction hole in the roof of Morgue 1 (“gas chamber”) of Crematorium II in December 1991. It is clearly visible that it was not cleared from the steel reinforcement rods. These were simply bent backwards.

²⁶⁹ I am grateful to Carl Hermann Christmann, a certified building engineer, for this information.

²⁷⁰ I am grateful to R. Faßbender, a certified building engineer, for this information, who also provided the drawings.

torium II which has remained largely intact. The only two holes which can be found today of anything approaching the diameter involved and somewhat regular and rectangular in shape were obviously crudely pierced at a later time, as may be seen in Figs. 45 and 43 (p. 110). Even Pressac admits that these are the only holes visible today.²⁷¹ Nevertheless his richly illustrated book includes not one clear photograph of these two existing holes.

All other smaller breakthroughs, cracks, and openings in the roofs of morgues 1 (“gas chamber”) of Crematoria II and III visible today are breaks in the reinforced concrete effected at a later time with the iron reinforcing rods sticking out. Nowhere does one find cleanly poured concrete edges or rough, chiseled out edges with some remaining plaster work; there are no remains of ascending concrete or brick/mortar stacks; no steel reinforcement rods running other than would be expected for an ordinary flat roof without holes; and there are no traces of any hoop irons, dovetails, or any other means of anchoring any device to the morgue’s floor, ceiling, or concrete pillars.

If any of these holes were used as Zyklon B introduction holes, they would have to have been broken through following completion of the roof, *i.e.*, shortly before the commencement of the alleged mass murders.²⁷² Such holes with no plasterwork to polish off their rough edges, however, could neither have been sealed against escaping poison gas, nor against intruding soil and water, nor would it have been possible to safely install any panic-proof introduction devices in them. Using such crude holes would truly be an incredibly stupid piece of bungling.

But there is more. In the opening shown in Fig. 45 the reinforcement rods were only separated and bent back. They possess their full length even today. One could bend them back again and weld them back together with their stumps, which are also visible to the left of the photograph (covered with snow).²⁷³ Nor is there any trace of reinforcement

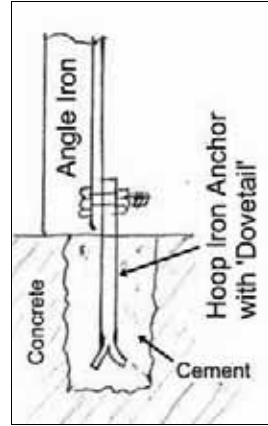

Fig. 46: Hoop iron with dovetail, cast in cement in a hole in concrete.

²⁷¹ J.-C. Pressac, *op. cit.* (note 72), p. 354.

²⁷² The ceiling was finished towards the winter of 1942/43, while the mass exterminations allegedly began in March 1943; see also J.-C. Pressac, *op. cit.* (note 72), pp. 338f.

²⁷³ Please do not attempt to bend them back again! More recent photographs show that individuals have obviously broken off two of the three reinforcement rods during similar such attempts.

One of these persons who unintentionally broke off one rod was Dr. Fredrick Töben in Febru-

rods running in a wreath-like pattern around the hole. This hole, therefore, can never have been used as an introduction hole; it was never finished. And what makes matters worse: this is still the “best” of all holes and cracks in this roof in existence today. All others are even more irregular and filled with reinforcement rods.

No apparatus, using the technology available at that time, could be anchored in such crudely pierced, unplastered holes, from which the reinforcement rods were not even removed; therefore, no gas introduction device could ever have been firmly installed, let alone sealed from the exterior. This means that the entire environment including the supposed perpetrators would have been endangered by the gas streaming out of the opening. The supposed victims could furthermore only have been prevented by force from escaping through these holes, or even throwing the Zyklon B back out through the hole, since these holes could obviously not be closed.

We might even go much further in this direction: we can tell from the concrete when at least one of the two large holes was pierced. An opening pierced through the concrete in the roof of either Morgue 1



Fig. 47: Notch (fatigue) effect resulting at inserted openings from the application of force. The only crack running through the wall proceeds, naturally enough, from the corner of the window.²⁷⁴

ary 1997, as he advised me personally after his visit to Auschwitz. Another rod was broken off later by unknown person(s), see Carlo Mattogno, op. cit. (note 180).

²⁷⁴ *Kurier*, Aug. 30, 1992, p. 20: “Wenn Felsen zu-fallen” (when rocks fall close).

(“gas chamber”) in consideration at a later time would inevitably have had the consequence, when the building was blown up, that the breaks and fissures caused to the roof by the explosion would have run preferentially through these holes.

The reason for this is that explosions exert extraordinarily great forces, and that the formation of cracks is favored by any weakness in the structure, since the tension peaks attain very high values in the vicinity of acute angles (notch effect, see Fig. 47).²⁷⁵ Such holes, in particular, which would already have damaged the structure of the concrete due to their incorporation following completion of the structure, represent not only points of likely fracture, but points of inevitable fracture. This is made more obvious by Figs. 48-53 (p. 116). Although the explosion pressure in the oven room, on an even level with the ground, could turn aside in all directions, and the roof remains relatively intact to the attic, three of the five oven room ventilation holes, cleanly cast and reinforced in the concrete roof, were completely destroyed. In the case of two of the other holes, clearly visible cracks formed at the corners, visible in the photos reproduced by Pressac.²⁶⁷

In the morgues of Crematoria II and III, the explosion pressure could only turn upwards, causing their roofs to be much more seriously damaged than the roof of the oven room. The alleged Zyklon B introduction holes in the roof of Morgue 1 (“gas chamber”) of Crematorium II, however, are conspicuous for having remained relatively intact; in the case of the hole in Fig. 45 all the cracks and fissures run around this hole! On the spot, one furthermore recognizes the arbitrary arrangement of this hole in a location at which the roof of the morgue is undamaged. This alone proves with technical certainty that this hole was broken through after the destruction of the roof!

The chisel marks on the edge of the hole in Fig. 43 are so similar to those in Fig. 45 that it must be assumed that both holes have the same history.²⁷⁶

There were therefore no holes in the ceilings of these rooms through which the poison gas preparation could have been introduced by means of wire mesh pillars or otherwise, as described by eyewitnesses.

Prof. van Pelt remarked accurately in this regard:²⁷⁷

²⁷⁵ Heinz Neuber, *Kerbspannungslehre: Theorie der Spannungskonzentration*, 4th ed., Springer, Berlin 2001.

²⁷⁶ Carlo Mattogno, *op. cit.* (note 180), has shown that the size of this hole actually increased over the years, probably because the Auschwitz Museum wants to give it a more regular, rectangular shape.

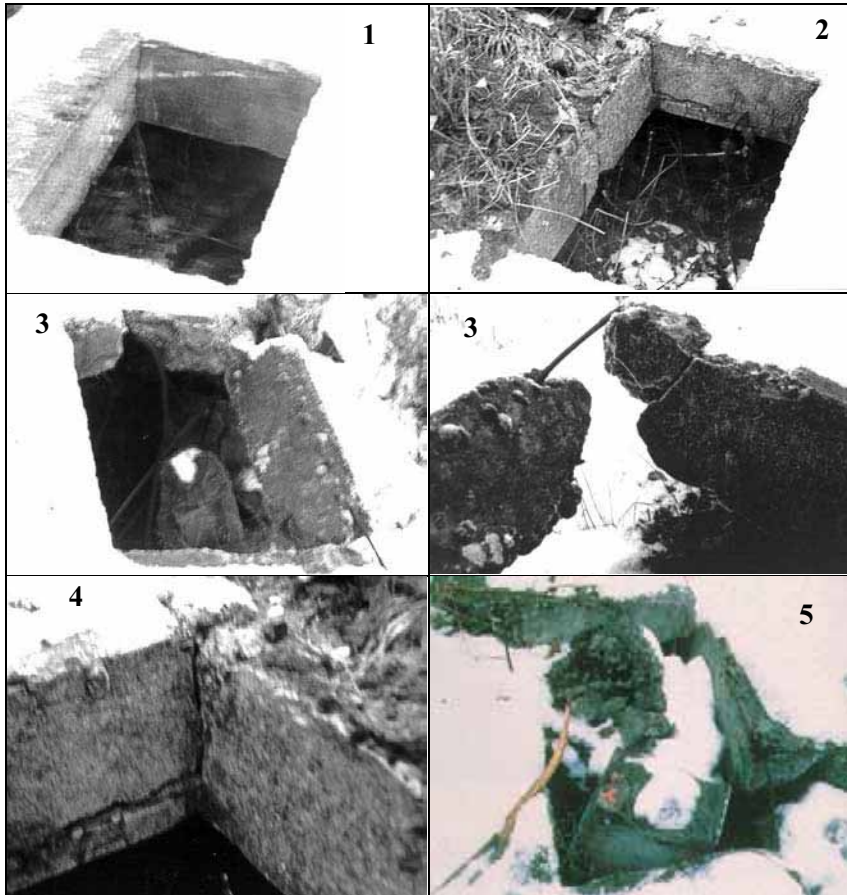

Figs. 48-53: The five properly constructed ventilation holes in the ceiling of the oven room to the upper story, Crematorium III (no. of holes indicated; #3 twice); condition: December 1991. Note the cracks caused by the explosion.

“Today, these four small holes that connected the wire-mesh columns and the chimneys [on the roof of Morgue 1, Crematorium II] cannot be observed in the ruined remains of the concrete slab. Yet does this mean they were never there?”

An interesting question, which the professor of architectural history answers as follows:

“While there is no certainty in this particular matter, it would have been logical to attach at the location where the columns had been some framework at the bottom of the gas chamber ceiling, and pour some concrete in the holes, and thus restore the slab.”

²⁷⁷ *Pelt Report, op. cit.* (note 71), p. 295; see also Brian Renk, “Convergence or Divergence?: On Recent Evidence for Zyklon Induction Holes at Auschwitz-Birkenau Crematory II,” *JHR* 20(5&6) (2001), pp. 33-51.

Van Pelt's claim that the camp administration could have filled the holes in the ceiling with concrete in the fall of 1944 in order to restore the ceiling, is without proof. But at least Prof. van Pelt believes that the SS administration acted logically, in that they allegedly attempted to wipe away all trace of their alleged crime. But does van Pelt really believe that it would have made more sense to fill up the holes with concrete instead of removing the entire roof of the "gas chamber," as was done with the roofs of morgues 2, the "undressing room"? An Allied air photo taken on December 21, 1944, shows that the roof of the other morgue, which is not alleged to have been used to commit any murders, was completely removed.²⁷⁸ Obviously the whole matter makes no sense. To believe van Pelt, we must believe, that the SS arbitrarily created architectural relics to confuse later tourists and Holocaust researchers instead of destroying the roof entirely, as in the case of the undressing room. This seems too absurd to be taken seriously.

But if van Pelt had the most rudimentary knowledge of architecture, he would know that it is impossible to remove holes measuring 70×70 cm (that is almost half a square meter!) from a concrete roof *without leaving clearly visible traces*. Actually, however, there are no traces of openings in the roof later closed with concrete.

In addition, concrete patches filled in later would have flown out of these holes like a cork out of a shaken champagne bottle during an explosion, thus making the holes just as visible as they were before. On closer inspection, Prof. van Pelt's allegation turns out to be not only demonstrably wrong, but utterly absurd.

But at least Prof. van Pelt agrees with the revisionists that there are no remains of these alleged holes. In remarking that there are no such traces, van Pelt has in fact proven that there were never any holes in the ceiling of this room, and, consequently, no Zyklon B introduction holes of any nature whatever, and, consequently, no introduction of any poisonous substances whatever in the manner described by the "eyewitnesses." He has proven that his "eyewitnesses" were lying. He has proven that there is no proof for the mass murders in Auschwitz. Actually, he has proven that there is no proof for the Holocaust. "No holes, no 'Holocaust'" (Robert Faurisson). It is beautiful to see the great Professor of Architecture Robert Jan van Pelt in the year 2000 come to the same conclusion as myself in the year 1991, when I investigated the

²⁷⁸ Dino A. Brugioni, Robert G. Poirier, *op. cit.* (note 260), p. 15; see also G. Rudolf, *op. cit.* (note 73), p. 39. I am grateful to Fritz P. Berg for this argument.

ceiling of the alleged “gas chamber” of Crematorium II of Birkenau. Only our conclusions are somewhat divergent.

At this point, I would like to introduce a witness who contacted David Irving by e-mail after conclusion of Mr. Irving’s legal proceedings against Deborah Lipstadt in May 2000. He is an engineer named Barford; his colleagues are assisting in the conservation and restoration of the camp for the Auschwitz Museum administration. He informed David Irving that, during his trial, investigations were made in complete secrecy at Auschwitz with regards to the mystery of the holes, and then remarked:

“[W]hat happened to their [the Auschwitz Museum’s] tests on the roof of Crema II mentioned in the attachment? Did they find the Zyklon B holes or not? Did they report those results to Lipstadt’s lawyers, and when? [...]”

As you can guess, despite my belief that you and the Revisionists are wrong, and despite spending half an hour examining the collapsed roof of the underground gas chamber of Crematorium II from different angles, I found no evidence of the four holes that the eyewitnesses say were there [...].

Secondly several areas of the slabs are covered in small rubble from an outer layer of concrete which was fractured by the blast. Now I would have expected these fragments to have fallen through the holes, if they were there, into the void beneath. [...]

I remain puzzled by the lack of physical evidence for these holes.”

In early 2000, the late Charles D. Provan distributed a paper claiming he had located the missing holes in the roof of Morgue 1 of Crematorium II.²⁷⁹ What Provan did, however, was simply to declare those cracks as “holes,” which were caused by the concrete support pillars piercing through the collapsing roof and cracks caused by the roof bending over the longitudinal beam. All holes described by Provan are full of reinforcement bars, they lack regular shape, have no straight edges and corners (as is to be expected for regular, planned-in holes), no traces of plaster (as is to be expected if holes were chiseled in later), no traces of chimney extensions to lead these stacks through the soil, no traces of anchoring devices (dowels, hoop irons, dovetails...). In his schematic drawing of the roof, Provan even possesses the boldness to display these cracks as holes with regular shapes.²⁸⁰ C. Mattogno has pointed out in detail how unfounded and distorted Provan’s claims really are.²⁸¹

²⁷⁹ “No Holes? No Holocaust? A Study of the Holes in the Roof of Leichenkeller 1 of Krematorium II at Birkenau” published by author in early 2000; online.

²⁸⁰ *Ibid.*, p. 36.

²⁸¹ Carlo Mattogno, *op. cit.* (note 180).

Finally, I want to focus on those legendary “Zyklon B introduction columns,” for which Michal Kula is the most frequently quoted “eyewitness.” He gives a detailed description of these columns which he claimed he had built.²⁸² J.-C. Pressac²⁸³ (see Fig. 54) and Prof. van Pelt²⁸⁴ have prepared drawings of these columns based on Kula’s description.²⁸⁵ First, the fact that there are no holes in the roof of the morgue in question measuring 70×70 cm – nor of any other size – categorically proves that Kula’s columns cannot have been installed. Next, there is neither material nor documentary evidence that these columns existed.²⁸⁶ All we actually

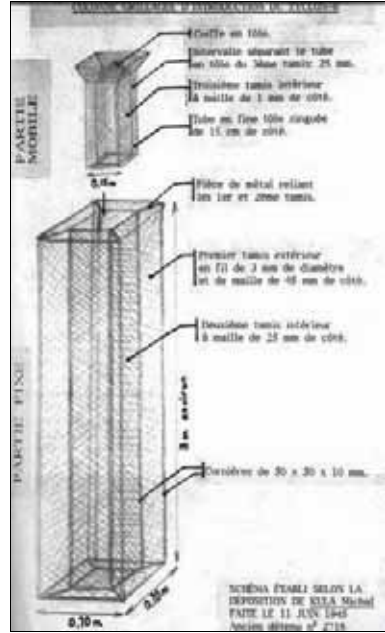

Fig. 54: J.-C. Pressac’s drawing of the legendary “Zyklon B introduction columns” as described by Michal Kula.²⁸³

have in this regard is a handwritten entry in an inventory list for Crematorium II²⁰² saying “4 Drahtnetz einschiebevorrichtungen,” which, literally translated means something like “wire mesh push-in device.” I have reproduced this handwritten entry in Fig. 55. The following points deserve to be pointed out:

- It is unknown, by whom and when this handwritten entry was made.
- This entry is made for morgue no. 2, the alleged dressing cellar, not(!) for Morgue 1, the alleged “gas chamber.”
- If Kula’s introduction columns would be included in this inventory list, they would appear with an appropriate name describing the whole thing, not just a “push-in device,” which could only be the inner part of Kula’s device.

²⁸² Höß trial, vol. 2, pp. 99-100.

²⁸³ J.-C. Pressac, *op. cit.* (note 72), p. 487; on p. 287, Pressac shows a rather primitive drawing with French inscriptions, probably prepared by a former French inmate on request of the Soviet investigation commission right after the war.

²⁸⁴ R. van Pelt, *op. cit.* (note 74), pp. 194, 208; *caveat emptor*: Though van Pelt’s translation of Kula’s testimony is erroneous, and though the data supplied in Kula’s testimony is rather meager, van Pelt uses it to make five different, very detailed drawings – some of it necessarily based on van Pelt’s fantasy, and the rest based on Kula’s fantasy.

²⁸⁵ See also Jamie McCarthy, Mark van Alstine, “Zyklon Introduction Columns,” www.holocaust-history.org/auschwitz/intro-columns.

²⁸⁶ C. Matogno, *op. cit.* (note 76), pp. 83-93.

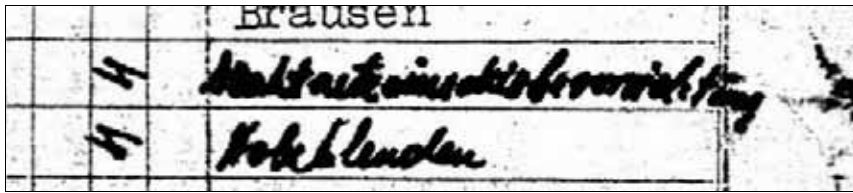

Fig. 55: Handwritten entries in an inventory list of Crematorium II for Morgue 2. The lower one reads “Holzblenden” (wooden blinds). The upper one may read “Drahtnetzeinschiebevorrichtung” (wire mesh push-in device)²⁰²

- In German, *schieben* describes horizontal (pushing) movements,²⁸⁷ whereas for vertically lowering an object, the word *laß* is used, i.e., *Einlaßvorrichtung* instead of *Einschiebevorrichtung*.

Whatever this handwritten entry really refers to, one thing is clear: it does not support Kula’s claim of the existence of complex Zyklon B introduction devices(!) in Morgue 1(!) of the Crematoria II and III.

Furthermore, M. Kula’s credibility as a witness must be considered very low, since he claims, for example, that he saw how corpses of gassing victims were carried away:

“I saw then that they [the corpses] were greenish. The nurses told me that the corpses were cracked, and the skin came off.”

As will be shown in chapter 7., victims of Zyklon B gasings aren’t greenish (they are pinkish-reddish), and there is no reason for the corpses to crack and for their skin to come off. This is nothing but atrocity propaganda.

But let us assume for a moment, the SS would have faced the problem of introducing HCN into the morgues 1 of Crematoria II and III after their roofs had been finished. I offer two options to solve the problem, and every reader might pick the solution that seems more likely:

- Pierce (2×4=) eight holes through the reinforced concrete roofs – a laborious and expensive task, leading to massive, irreparable damage to the roofs’ layer of tar and upper cement layer; add (2×4=) eight brick or concrete chimneys of at least 1 m height to lead the holes through the layer of soil on top of the roofs, and attempting to repair the damage done to the roof by the violent hole piercing process – another laborious, material consuming, and expensive task; design and construct (2×4) eight wire mesh columns 3 m high, consisting of three parts: a panic-proof, outer column made of massive steel (which does not correspond to Kula’s claims, though), a middle wire mesh column (with no purpose at all but to hinder the HCN from

²⁸⁷ E.g., a cabinet’s drawer is a *Schublade* (the German verb *schieben* (to push) is irregular: *schieben, schob, geschoben*; noun: *Schub*=thrust).

spreading out), and a removable inner wire mesh column, another laborious, material- as well as time-consuming, and expensive task; find a way to anchor these eight devices panic-proof in the concrete floor, ceiling and pillars, another laborious and expensive task; all these works had to be planned, approved, tested, and material had to be allocated, leaving a thick and long “paper trail” of documents (which, by the way, doesn’t exist); but finally, all one would possess at the end would be a primitive device allowing for the simple introduction of Zyklon B by pouring it into the inner column; one had to sit and wait for a long time until a lethal amount of HCN had evaporated from the Zyklon B carrier and had spread into the morgue, or alternatively, one had to apply an excessive amount of Zyklon B to ensure high evaporation rates for quick execution success, and remove and destroy the Zyklon B after the gassing, though only a fraction of the HCN had been released by then.²⁸⁸

But there was a second, much simpler option:

- b) Installing a simple basket – to hold Zyklon B – in the air intake ventilation shaft of Morgue 1 right after the easily accessible intake ventilator, which then would blow the HCN vapors right into the “gas chamber,” similar to the Degesch circulation procedure. This would have reduced the gassing time and the amount of Zyklon B required to a fraction compared to any scenario where Zyklon B is simply kept closely together on heaps without any moving air.²⁸⁹

Also, one could have drastically increased the evaporation rate of the Zyklon B in this basket even further, hence accelerating the execution procedure. All that would have been required was to alter an idea the Topf engineers had in early March 1943. When facing cooling problems of the cremation chimney’s forced draught blowers, the Topf engineers suggested to use the excess heat produced by these engines to pre-heat the morgue. The only constructional change needed for this was to redirect this excess heat into the morgue’s air intake duct (see chapter 5.4.1.2.5., p. 99). Though the forced draught blowers overheated and were damaged shortly the-

²⁸⁸ For evaporation rates of Zyklon B, see chapter 7.2. and 7.3.1.3.

²⁸⁹ The brick-built air intake duct was easily accessible from the attic, where the fans were installed, and from the ground floor; see J.-C. Pressac, *op. cit.* (note 72), pp. 276, 291, 329, 369. The use of the air intake fan to introduce HCN would have lead to some HCN losses through the air exhaust chimney already during the gassing, thus endangering anybody close to those crematoria, but certainly not more than would have been the case when all the HCN had to be removed after the end of a hypothetical gassing, so this would not be an argument against this technique. Also, such a loss of HCN is minimal compared to the loss following Kula’s scenario. For more on this, see chapter 7.3.1.3.

reafter,²⁴⁰ it would have been easy to construct a short air duct from the furnace chimney to the air intake duct of Morgue 1 instead. In this way, warm air coming from the crematory ovens (suffocatingly low in oxygen) would have been redirected over the Zyklon B basket into Morgue 1, supplying this room with warm, oxygen-depleted air enriched with HCN.

I assume the point I am making is clear: there were all sorts of cheaper and less complicated solutions available than suggested by Michal Kula. His solution is simply impracticable and is an insult to every engineer's and architect's intelligence – naturally bearing in mind the fact that the ruins of Crematorium II clearly prove that no such columns were ever installed anyway.

5.4.1.2.9. Conclusions

Pressac's "criminal traces" have been refuted on structural engineering grounds. So, too, have all the "eyewitnesses," who have been discredited without exception. The alleged homicidal "gas chambers" are therefore refuted upon the grounds of building engineering alone. Or, in Robert Faurisson's words:

"No Holes, No 'Holocaust'"

In summary, the arguments relating to the introduction columns may be listed as follows:

Table 1: Arguments relating to the Zyklon B introduction columns

ALLEGATION	FACT
Zyklon B introduction stacks are visible on Morgue 1 ("gas chamber") Crematoria II and III on an air photo.	An analysis of this air photo proves that the spots visible have no spatial height, have an irregular shape, an incorrect size (much too long and wide), and irregular directions different from real shadows; these spots can therefore neither be shadows of any objects, nor can they be the legendary Zyklon B introduction stacks.
The filling stacks are visible on a ground photo of Crematorium II.	These three objects are only visible on one photograph; on others they are missing. They stand closely together, have different dimensions and irregular alignment. Introduction stacks would have the same size, a regular alignment and be evenly distributed over the roof. The objects do not accord with the holes actually found, either in location or in number.

ALLEGATION	FACT
For planned introduction holes, cleanly cast and reinforced holes with concrete/brick stacks protruding over the layer of soil laying on this roof would have to be expected.	The only two holes deserving this name clearly show chisel marks; the concrete structure was destroyed at a later time; there are no smooth, cast concrete edges and surfaces, no stack-like elevation to prevent the entry of rain water and soil into the hole. All other cracks and openings are highly irregular, filled with reinforcement rods, and obviously caused by the collapsing roof being pierced by pillars and bent over the longitudinal beam.
For holes chiseled in, the reinforcement rods would have to be removed, the edges polished off, and a protruding stack built. Such holes would be severely damaged by an explosion.	In all cases the reinforcement rods still project into the holes; in one case, these were only cut through and bent back. The edges of all holes and cracks were not plastered; the tar insulation is openly visible; there is no trace of any stacks added. The “best” of these holes is in an area unaffected by the explosion that blew up this morgue, proving that this hole was chiseled in after the war.
The installation of introduction devices running from the ceiling to the floor requires panic-proof fixtures, like massive dowels and hoop irons with dovetails	No trace of such fixtures can be found anywhere, hence no such devices were ever installed. There is also no documentary or physical evidence that such devices ever existed.

5.4.2. Crematoria IV and V

Figure 56 (p. 125) shows the ground plan of Crematorium IV and mirror-symmetrically that of Crematorium V.²⁹⁰ Based on cost considerations, these buildings, planned and begun later, were constructed in a simpler manner than Crematoria II and III. Due to low quality materials, the ovens of both crematoria broke down shortly after the putting into operation of the installation. They were not repaired due to crematorium over-capacity. There are few documents as well as contradictory and, to some extent, incredible eyewitness testimonies relating to these installations, which, according to Pressac, must be considered the least well-known.²⁹¹

These crematoria were planned starting in the summer of 1942 and built until early 1943. According to Pressac, in addition to the two

²⁹⁰ Plan received from R. Faurisson. The same plan is found in J.-C. Pressac, *op. cit.* (note 72), p. 401, but of very poor quality.

²⁹¹ J.-C. Pressac, *op. cit.* (note 72), pp. 379ff., chapter on Crematoria IV and V: “[...] the least known of the instruments of extermination [...] a comparison of such testimonies reveals inconsistencies.”

western rooms, which bear no designation in the plans, the vestibules are also supposed to have been used as homicidal “gas chambers.” All these rooms allegedly possessed gas-tight hatches with wooden shutters approximately 1.50 m from the floor and measuring 30×40 cm, in the exterior walls, for the introduction of Zyklon B,²⁹² which are later supposed to have been widened to 40×50 cm.²⁹³

Both rooms had heating furnaces that needed to be fired from the vestibule, which, according to Pressac, was allegedly also used as a “gas chamber.” No ventilation installation is known to have existed. Pressac assumes ventilation by natural convection.²⁹³ Franciszek Piper, Director of the Auschwitz Museum, agrees.¹⁶⁹

“There were plans for mechanical ventilation of the Zyklon B, but these were not put into effect. Evacuation of the gas was instead achieved by convection, that is, by merely opening the doors.”

Pressac alleges the later incorporation of a door in the corridor for natural ventilation support, but without proving it.²⁹⁴ Since it would hardly have been any more expensive for the SS to provide for mechanical ventilation in these rooms, and since this solution would have been considerably more effective, Pressac’s argument of the installation of a door for ventilation can be rejected as unrealistic. It is also obvious that the morgue and oven room possessed ventilation chimneys. The rooms which purportedly served as “gas chambers,” however, are the only rooms which, apart from the coke room and doctor’s office,²⁹⁵ possessed *no* ventilation chimney!

According to an older Pressac publication,²⁹⁶ these “gas chambers” were not planned and built as such either, which he bases, among other things, on the fact that the absence of a ventilation installation would have led to a need to evacuate the entire building for many hours during a gassing.²⁹⁷ It is, in fact, inconceivable for a gas chamber *not* to possess a ventilation system, regardless of the purpose for which it was designed.

²⁹² *Ibid.*, p. 384. For an illustration of the gas-tight door and hatches, see pp. 46-49, 425-428, 486, 500.

²⁹³ *Ibid.*, p. 386.

²⁹⁴ Pressac points to a photo of Crematorium IV, *ibid.*, p. 417, as proof of his hypothesis. But since the photograph was taken from the south side while the corridor lies on the north side of the building, the door shown in the plan is the access, drawn on the plan, to one of the undesignated rooms. If he means to refer to Crematorium V, hidden in the forest in the background, then it is impossible to claim seriously that anything can be recognized on this photo.

²⁹⁵ A doctor’s office in crematoria, by the way, is quite normal, even today; see also E. Neufert, *op. cit.* (note 182).

²⁹⁶ J.-C. Pressac, *Le Monde Juif*, no. 107, Juli-September 1982, pp. 91-131.

²⁹⁷ Pressacs argues this way in his new book as well, *op. cit.* (note 95), pp. 67, 89.

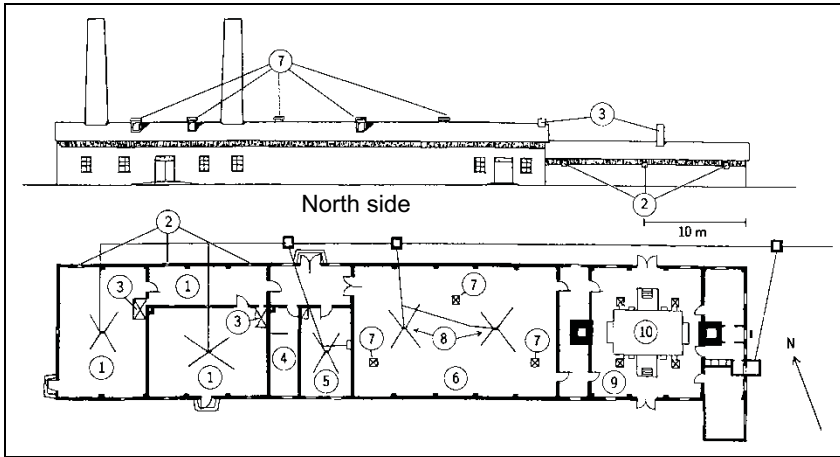

Fig. 56: North lateral view (above) and ground plan (below) of Crematorium IV and/or V (mirror image) in Auschwitz II/Birkenau camp.²⁹⁰

- 1: Alleged "gas chambers"; 2: Alleged Zyklon B introduction hatches; 3: Heating ovens; 4: Coke room; 5: Doctor's office; 6: Morgue; 7: Ventilation chimneys; 8: Gullies; 9: Oven room; 10: Crematorium ovens

In his new book, Pressac leaves these arguments unchanged.²⁹⁸ Since the mass extermination of the Jews was supposed to have been already fully underway – particularly, in farmhouses I and II – when Crematoria IV and V were being planned, it is, of course, absurd to believe that these installations could have been incorrectly designed and built. Today, therefore, Pressac assumes a "criminal planning" of the crematoria.²⁹⁹ The claim of such criminality is allegedly supported by various documents mentioning the "installation of gas-tight [sic] windows," "pouring concrete floor in gas chamber," and repeated mentions of gas-tight doors in various connections.³⁰⁰

As already shown in the chapter on the disinfestation of personal effects, the German word "*Gaskammer*" (gas chamber) was the designation commonly used at that time for the disinfestation of personal effects. The combination of crematoria and disinfestation installations in one and the same building was very common practice at that time.³⁰¹ Indications have since been found leading to the inference that it was initially planned to use the rooms referred to in some documents as "gas chambers" for disinfestation purposes.

²⁹⁸ J.-C. Pressac, *op. cit.* (note 72), p. 386.

²⁹⁹ *Ibid.*, p. 447.

³⁰⁰ *Ibid.*, pp. 406, 442-455.

³⁰¹ For a prominent example, one need only consider Dachau concentration camp, the crematorium building of which contained a series of Degesch circulation delousing chambers, see p. 59.

In the case of Crematoria IV and V, one must assume that the rooms in question here were intended for disinfestation purposes, but perhaps never completed for this purpose, let alone used. In any case, there is no evidence that ventilation systems absolutely necessary for the use of HCN were ever installed.³⁰² The reason for this may lie in the fact that starting in early 1943, the Germans were working on the completion of a large hygienic complex with a large hot air disinfestation installation (the so-called “Zentralsauna”) in the immediate vicinity of these crematoria, and were also anticipating the early use of microwave disinfestation installations as promised by Berlin (see chapter 5.2.3.6.).

Mattogno has shown that documentary evidence points at the installation of showers in the two rooms in question within these crematoria, which sport waste water gullies. These works, which are referred to as “water installations” or “sanitary installations” in the documents, lasted from March 15 to April 23, 1943, and comprised for a total of 816 man-hours. Mattogno posits that the large stoves installed in these rooms served to both heat the rooms and provide hot water for the showers. The moisture in those shower rooms would also explain why the lamps were placed in recesses.³⁰³ This supports the thesis that these rooms served as hygienic centers. Mattogno also concludes from the extant documents that the vestibule may have been considered to serve as a disinfestation gas chamber.³⁰⁴

W. Rademacher has remarked that Pressac personally quotes a document by means of which “210 gas door anchorings” were ordered in Auschwitz. This document indicates that the term gas-tight (“*gasdicht*”) does not necessarily constitute a reference to execution of disinfestation chambers, since it has never been claimed that there was a need for roughly one hundred doors for homicidal “gas chambers” at Auschwitz.³⁰⁵ It is entirely possible that all doors and windows were designated as “gastight,” if they were equipped with felt insulation and were therefore sealed off against air currents, a characteristic not at all common in windows for inmate barracks in a concentration camp.³⁰⁶

³⁰² J.-C. Pressac, *op. cit.* (note 95), pp. 89f., alleges, in this regard, that a ventilation installation was built into Crematorium IV only in late May 1944, but his remarks are untenable in this regard; see also G. Rudolf, “Some Technical and Chemical Considerations about the ‘Gas Chambers’ of Auschwitz and Birkenau,” in: G. Rudolf (ed.), *op. cit.* (note 24), pp. 347f.

³⁰³ J.-C. Pressac, *op. cit.* (note 72), pp. 399f.: “Kavernischen” / “Wand-Lampen versenckt [sic].”

³⁰⁴ C. Mattogno, *op. cit.* (note 76), pp. 177-179.

³⁰⁵ W. Rademacher, *op. cit.* (note 251), p. 80; J.-C. Pressac, *op. cit.* (note 72), p. 451.

³⁰⁶ At least the windows of those inmate barracks still accessible today in Birkenau have been installed in a very sloppy way, so that the wind blows intensely through the gaps. It is, however, questionable whether these barracks are authentic or were rebuilt after the war.

Pressac himself provides yet another item of proof that the term “gas chamber” has no criminal significance in Auschwitz documents. One document states: “1 key for gas chamber.” Since all “gastight” doors found at Auschwitz, as well as all surviving photographs of such doors, show that these doors had no locks, this document must refer to a door for another type of room, such as a room for the storage of Zyklon B, which truly required storage under lock and key.³⁰⁷

The walls of Crematoria IV and V, which were built entirely above ground, were of simple brick masonry. After they were blown up, both buildings were demolished to their foundation walls and concrete foundations. The foundation wall of Crematorium V, which today is approximately 1 m high, is supposed to have been rebuilt.³⁰⁸ The foundation wall of Crematorium IV, which is approximately 50 cm high, is also supposed to have been rebuilt out of other rubble at a later time.⁶¹

Even these ruins can still speak to us, even if, in this case, only the concrete foundations are authentic. Another technical precondition for the use of the rooms alleged to have been homicidal “gas chambers” would be that it would have to have been rendered impossible for the victims on the inside to get anywhere near the introduction hatches, since otherwise they could have simply pushed the SS man off the ladder while he was throwing the Zyklon B into the chamber; they could then have attempted to escape. A U-shaped, solid steel grid construction anchored in the floor and in the masonry of the walls with steel hoop anchors spread out into dovetails would have been necessary to keep the victims on the inside at arm’s length from the hatches. The concrete floors of these rooms surviving today, however, make it clear that nothing of the sort was ever anchored in the floor.

Mattogno has recently discovered that the small openings in those rooms, which came in two sizes of only 15×25 cm or 20×30 cm when deducting the frames, had iron bars in front of them. This would have made it impossible to stick a can of Zyklon B through them, hence the introduction of the poison as attested to by witnesses was not possible.³⁰⁹

5.4.3. Farmhouses 1 and 2

According to eyewitness accounts, there are supposed to have been two farmhouses (sometimes referred to as bunkers 1 and 2), located

³⁰⁷ J.-C. Pressac, *op. cit.* (note 72), p. 456.

³⁰⁸ *Ibid.*, p. 390.

³⁰⁹ C. Mattogno, *op. cit.* (note 76), pp. 168ff.

westnorthwest of the Birkenau camp, which were converted into homicidal “gas chambers.” Their location and construction are not, however, exactly described. Pressac mentions contradictory eyewitness reports in this regard.³¹⁰ Relating to the testimony of P. Broad, for example, he writes: “[...] not exploitable [...], since it has been rewritten by and for the Poles [...],” and: “It is impossible to make a synthesis of all these accounts.” Höß’s report relating to the characteristics and location of these buildings is only superficial.³¹¹ According to remarks in the judgment to the Frankfurt Auschwitz trial,³¹² the homicidal mass gassings are supposed to have taken place in a manner similar to those in the chambers of Crematoria IV and V, as described above. This procedure is clarified by the testimony of Richard Böck,³¹³ and, to a certain extent, by Milton Buki,³¹⁴ Rudolf Höß, Szlama Dragon, Maurice Benroubi, Moshe Maurice Garbarz, Johann Paul Kremer (at the Frankfurt Auschwitz trial), and André Lettich.³¹⁵

Pressac has published a photograph of what are alleged to be the remains of the foundation walls of farmhouse 2.³¹⁶ According to analyses of Allied air photographs, there was only temporarily a building in the vicinity of the location ascribed to farmhouse 2; there is no trace of farmhouse 1.^{264,317} The extermination of the Hungarian Jews is supposed to have been underway when the air photos were taken, with many thousands of victims per day and strongly smoking cremations in large open ditches precisely in the area analyzed.³¹⁸ There is no trace of large cremation ditches, large fires giving off copious smoke, or large stockpiles of fuel. Only on air photos made during the winter of 1944/1945, a few mass graves can be seen west of Crematorium III – probably for the victims of the chaotic circumstances in the camp after

³¹⁰ J.-C. Pressac, *op. cit.* (note 72), pp. 161ff.

³¹¹ R. Höß, in: M. Broszat (ed.), *Kommandant in Auschwitz*, Deutsche Verlags-Anstalt, Stuttgart 1958.

³¹² Judgment of the so-called Frankfurt Auschwitz Trial, ref. 50/4 Ks 2/63, p. 99; see note 88.

³¹³ Interrogation of the eyewitness R. Böck during pre-trial investigations for the so-called Frankfurt Auschwitz Trial: Staatsanwaltschaft beim LG Frankfurt (Main), Strafsache beim Schwurgericht Frankfurt (Main) gegen Baer und Andere wegen Mordes, ref. 4 Js 444/59, sheets 6878ff. Quoted: sheet 6881f.

³¹⁴ J.-C. Pressac, *op. cit.* (note 72), p. 163.

³¹⁵ See also J. Graf, *Auschwitz. Tätergeständnisse und Augenzeugen*, *op. cit.* (note 47).

³¹⁶ J.-C. Pressac, *op. cit.* (note 72), p. 176.

³¹⁷ Pfeiffer, Hansa Luftbild GmbH, aerial photographic analysis of Allied photograph dated Aug. 25, 1944 (note 260), letter dated July 17, 1991; J. Konieczny (=Miroslaw Dragan), *The Soviets, But Not the Western Allies, Should Have Bombed the Auschwitz Camp*, Polish Historical Society, unpublished paper.

³¹⁸ J.-C. Pressac, *op. cit.* (note 72), p. 253.

the Germans started to shut down and dismantle the equipment in fall of 1944 during their withdrawal.³¹⁹

Documents discovered by Werner Rademacher in a Moscow archive prove that one of these farmhouses which really did exist was used – for disinfestation. The SS, in particular, was (at least in theory) prohibited from carrying on the disinfestation of personal effects with Zyklon B inside the camp whenever there was a safety risk. The conversion of a farmhouse, which was located outside the camp and whose utilization as provisional HCN disinfestation installations would not have involved any safety risk for the camp itself, could have resulted from this difficult situation. Several documents are now available which refer to an “existing building” outside of construction section B III, in which a bath and sauna were to be installed.³²⁰

In late 2001, several European newspapers reported that an Italian scholar had discovered the “bunker 1” in Birkenau.³²¹ As C. Mattogno has shown, however, this is nothing but a hoax. The farmhouse allegedly identified as the old bunker is at a totally different location than the alleged bunker 1 supposedly was, and it was never anything else but a farmhouse.³²²

5.4.4. The Drainage System in Birkenau

5.4.4.1. Background: Eyewitness Accounts

J.-C. Pressac quotes various eyewitnesses claiming that due to the restricted capacity of the Auschwitz crematoria, a large portion of the bodies of the victims of homicidal mass gassing were cremated in open-air pits. These pits were allegedly located north of Crematorium V as well as close to the farmhouses (bunkers) 1 and 2. The size of these pits is described as roughly 20-60 m long, 3-7 m wide, and 1.5 to 3 m deep.³²³

³¹⁹ See J.C. Ball, in: G. Rudolf (ed.), *op. cit.* (note 24), p. 281.

³²⁰ *RGVA* 502-1-24-77, Nov. 30, 1942; 502-1-24-33, Dec. 3, 1942; 502-1-332-46a, Jan. 9, 1943; 502-1-26-66, April 9, 1943; 502-1-238-10, Sept. 30, 1943.

³²¹ *Le Monde*, Nov. 20, 2001; *Bild*, Nov. 20, 2001; *Corriere della Sera*, Nov. 21, 2001, p. 35.

³²² Cf. Carlo Mattogno, “The ‘Discovery’ of ‘Bunker 1’ at Birkenau: Swindles, Old and New,” *The Revisionist*, 1(2) (2003), pp. 176-183; on this topic see also in general: C. Mattogno, *The Bunkers of Auschwitz. Black Propaganda versus History*, Theses & Dissertations Press, Chicago 2004.

³²³ J.-C. Pressac, *op. cit.* (note 72), p. 162-164, 171, 177

5.4.4.2. The Ground Water Table in Birkenau

In his expert report, Fred Leuchter pointed out that due to the high ground water table he found in Birkenau in 1988, it would have been impossible to dig deep pits and to light and maintain a fire in them.³⁰ The reason for the high ground water table is that the Birkenau camp lies in the immediate vicinity of the confluence of the Sola river into the Vistula river. A few hundred meters away from the camp one finds swampy meadows even today.

Leuchter, however, did not investigate the important question of whether the ground water table was similarly high in 1942-1944, when the events attested to by the witnesses took place. It has been pointed

out that the Birkenau camp had a sophisticated grid work of drainage canals which lowered the ground water table.³²⁴ This drainage system is still functioning fairly well to this day. Whereas the ground water table around the camp is basically right at the surface, it is today lowered to 60 to 70 cm under the surface within the camp, obvious, for example, from Figure 57. The photo was taken on August 15, 1991, during a long period of drought. It shows a construction trench in front of the *Zentralsauna* located in the western part of the camp.

But how effective was this drainage system in 1942-1944, and most importantly, how effec-



Fig. 57: *Then and today – the unchanged ground water state in the Birkenau camp, here in midsummer 1991, in a construction trench in front of the Zentralsauna, approximately 70 cm. Incinerations of corpses in pits many meters deep, in accordance with witness testimony, were not possible.*

³²⁴ J.-C. Pressac, *op. cit.* (note 72), p. 209, drainage plan POW camp Birkenau.

tive was it in the area north of Crematorium V and in the vicinity of the alleged farmhouses, which were located *outside* of the camp's drainage system?

There are two pieces of circumstantial evidence indicating that the water table was not much different then than it is today. The first evidence is the well known small pond in the vicinity of Crematorium IV, which is supposed to have existed the same way during the war. If the drainage system had lowered the water table by several meters, the pond next to Crematorium IV, contrary to many witness statements, would have dried up. This proves the unchanged water table from then until now. The second evidence is the subterranean location of the morgues of crematoriums II and III, as well as some of the building sections of the *Zentralsauna*. They all were constructed by insulating the buildings' basements from intruding water with a waterproof layer of tar, which indicates that there was a need to protect against such water in the first place. Also, since the drainage ditches in the camp are only 1 to 1.5 meters deep, they could not have lowered the water table to less than one meter. This maximum value, though, can only be achieved in the immediate vicinity of the ditches.

In complementary studies, Michael Gärtner and Werner Rademacher on the one hand¹⁸⁸ and Carlo Mattogno on the other hand³²⁵ have shown, with a vast amount of contemporary German documents dealing with the camp authorities' problems caused by the high water table, that between the end of 1941 and middle of 1944, the water table in Birkenau in general and outside the camp perimeter in particular was very high, coming close or even reaching the surface and turning the entire area into a swampy region. All three authors showed that construction on buildings with basements was possible only by permanently pumping off ground water, and Mattogno even found documents expressively *forbidding* the digging of pits for outhouse latrines, because this would contaminate the drinking water of the entire Auschwitz region. Mass incinerations of corpses in deep pits, of course, would have contaminated the drinking water as well, hence would never have been permitted.

³²⁵ "'Verbrennungsgruben' und Grundwasserstand in Birkenau," *VffG* 6(4) (2002), pp. 421-424; Engl.: "'Incineration Pits' and Ground Water Level in Birkenau," *The Revisionist*, 1(1) (2003), pp. 13-16.

5.4.4.3. Open-Air Incineration in Pits

In general, it is of course possible to burn corpses in open-air pits, though it certainly takes more time and fuel than any cremation in a crematorium, and it also leaves many more traces due to incomplete combustion. In 1999, Dr. Myrosław Dragan conducted an experimental incineration of an 80 lbs. deer in a pit roughly 1 m deep, 70 cm wide, and 1.2 m long. This incineration with a relatively small amount of wood lasted some 4-5 hours and was almost completely successful.³²⁶ Dr. Dragan found out that for open-air incinerations, small, narrow holes are advantageous over large, wide holes or, even worse, cremations on ground level, since the soil walls of a pit act like the walls of a crematorium oven, storing and reflecting a great deal of the heat produced by the fire – provided that the soil has a considerable amount of clay stabilizing the wall of the pit, and, of course, that no ground water flows into the pit and extinguishes the fire.

The situation in Birkenau, however, was drastically different from that. Not only did the witnesses claim that those pits were very wide, but as Gärtner, Rademacher, and Carlo Mattogno have shown, the

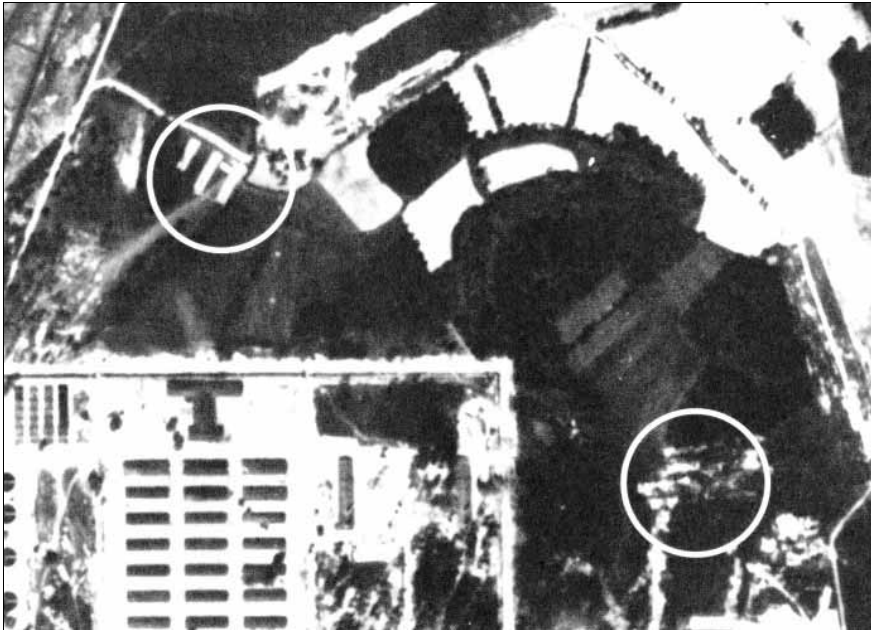

Fig. 58: *White circles: possible sites of old mass graves of typhus victims in Auschwitz.*

³²⁶ Only small pieces of the skull were left over which were located in a corner of the pit. Communications of Dr. M. Dragan, whom I helped to investigate the carcass' remains in June 1999.

ground water table in the areas around the alleged location of those cremation pits was so high that it would have been impossible to dig such deep pits, arrange hundreds of corpses and fuel in them, and maintain a fire for many hours without these pits quickly filling with water. These findings show clearly that the attested burning of corpses in pits many meters deep was impossible under such conditions, since these pits would have filled up with ground water rather quickly.

It is known that in Birkenau the corpses which had accumulated during the typhus epidemic of the summer of 1942 were first buried in mass graves. Due to the danger of the contamination of the ground water, however, they had to be exhumed shortly afterwards. Since the new cremation facilities were still under construction then, it is possible that at least a portion of the corpses were burned on funeral pyres. For this purpose, as a rule, one removes the turf and the upper layer of topsoil in order to preserve them from damage and to absorb the ashes of the wood and the corpses. But holes many meters deep are not dug.

Indeed, one can unearth in excavations west of the Birkenau camp ashes and bone splinters (whether from humans or cattle remains open) to the depth of several decimeters, intensively mixed with all kinds of refuse (glass and porcelain shards, slag, bits of iron, etc.). Apparently this place served as a rubbish heap for the camp under German administration and/or after the war under Polish administration.

In his detailed study of aerial photos of the Birkenau camp made by the allied surveillance planes, J.C. Ball has revealed that at no point in time in the summer and autumn of 1944 in the camp or in its environs were large incineration pits – and fuel stockpiles necessary for that – to be seen, let alone flames and smoke, as are repeatedly attested to.³²⁷ He did, however, locate the places where mass graves had existed (see Fig. 58).³¹⁹

5.5. Construction Conclusions

Even the most primitive temporary disinfection installations – whether in the initial period of the life of Auschwitz camp or elsewhere – were always equipped with ventilation and a heating system, the last being, of course, useful but not absolutely necessary. But no room not possessing a ventilation system need be considered as a room for repeated fumigation with poisonous gases, whether for lice or human beings. Homicidal “gas chambers” must furthermore be panic proof and

³²⁷ J.C. Ball, *op. cit.* (note 263).

Table 2: Equipment and suitability of actual or alleged “gas chambers”

Equipment Building	Poison gas introduction	Heating	Ventilation	panic proof	Suitable for disinfestation	Suitable for mass homicide
Disinfestation room	○	●	●	○	yes	if panic-proof
Crematorium I	×	×	●	×	perhaps	no
Crematoria II and III	×	×	●	×	perhaps	no
Crematoria IV and V	×	●	× / ?	×	hardly	no
Farmhouses I and II	○	?	?	×	hardly/perhaps	no

● = present or possible; ○ = possibly present; × = not present; ? = unknown

have to be equipped, apart from the entry doors, with an opening for the introduction of the poison gas material from the outside; the latter is not absolutely necessary for disinfestation installations, but is nevertheless useful. It must be concluded, therefore, that no installation possessing neither a poison gas introduction device from the outside, nor any possibility of ventilation, nor panic proof equipment can seriously be considered to serve as a homicidal “gas chamber.” If one considers the rooms discussed above in a summary manner, the results are shown in Table 2.

Not taken into consideration in the above, among other things, is the fact that the ventilation system of hypothetical homicidal “gas chambers” would have to be efficient enough for homicidal purposes, which, in view of the above, was not the case, and that the evacuation of the poison gas into the environment after the gassing/execution required special measures in order to avoid that people close to the “gas chambers” – both inside the building as well as in its vicinity – get hurt or even killed.

Although the literature is generally unanimous as to the equipment of the rooms in Crematoria IV and V, the information is, to a certain extent, speculative due to the lack of documents and material evidence. This applies even more so to the farmhouses, on which practically no documents exist.

Fortunately, it is precisely the one “gas chamber” in which the largest number of people was allegedly killed by poison gas during the Third Reich which has remained almost entirely intact: Morgue 1 of Crematorium II. Contrary to all eyewitness testimony, this cellar, during the period of its operation, possessed no Zyklon B introduction holes in the roof, and none of its equipment (door, alleged introduction columns) was panic-proof. It is only logical and consequent to transfer these conclusions also to the mirror-symmetrically built, but otherwise identical Crematorium III, even though we do not possess any physical evidence for this due to the almost complete destruction of the roof of its Morgue

1. If this is so, then those rooms cannot have been used as locations for mass homicide using poison gas, as alleged by witnesses.

When one considers the technical circumstances prevailing in and around Auschwitz in the broadest sense, one becomes aware of the absurdity of the entire claim of homicidal mass gassings. The camp management was fully aware of the methods and technical preconditions for Zyklon B disinfestation, and was even informed as to the latest developments in the related technology.¹⁴⁷ But instead of using these methods, it allegedly took recourse, for mass gassing purposes, to extremely crude methods, particularly where the farmhouses I and II, and, later, Crematoria IV and V were concerned:

Allegedly, hundreds or thousands of people were killed with highly poisonous gas in rooms,

- which had walls and ceilings made of a material absorbing huge amounts of the poison gas and letting it penetrate;
- which did not have escape-proof doors and windows;
- which did not have panic-proof equipment;
- which did not have technically gastight doors and shutters;
- which had no provision to quickly release and distribute the poison gas,³²⁸
- which had no effective device to ventilate or otherwise render ineffective the poison gas after the end of the execution.

At the same time, the most modern disinfestation installations were being built all over German-occupied Europe,

- which had walls and ceilings covered with gastight coatings;
- which were equipped with escape-proof doors and had *no* windows;
- which had technically gastight doors;
- which had devices to quickly release and distribute the poison gas;
- which had effective devices to ventilate or otherwise render ineffective the poison gas after the end of the gassing procedure.

There were never any perceptible delivery problems for these installations. In the Auschwitz main camp, the latest technology for disinfestation using HCN was incorporated (cf. chapter 5.2.3.5.), while the *Zentralsauna* at Birkenau was equipped with the most modern hot air disinfestation technology! And to top it all off: the Germans even invented

³²⁸ Richard J. Green's claim (*op. cit.*, note 218, p. 31) that "there were in fact devices to distribute the gas over the room" is wrong. He refers to a paper dealing with M. Kula's columns (J. McCarthy, M. van Alstine, *op. cit.*, note 285), but those would have *prevented* rather than facilitated the distribution of the gas (see page 119 and 184 of this present book).

the microwave technology, which is so well-known today, *to kill lice!* They erected these installations, which were still very expensive at that time, in Auschwitz camp, *to save inmate lives!* And we are supposed to believe that the Germans were incapable of installing adequate technical equipment for Zyklon B gassings in at least one of their alleged homicidal “gas chambers”! Can anything be more insulting to the human mind?

So much for the claim that homicidal “gas chambers” existed at Auschwitz. We have also proven that the largest room, the one allegedly most-often used as a homicidal “gas chamber,” could not have been used for that purpose as stated by alleged eyewitnesses. Together with the untruthful witnesses to a homicidal “gas chamber” in the Main Camp (see chapter 5.3.), and in view of the fact that there is no documentary indication of a criminal use of these rooms, we must conclude that there is no credible proof, and no “criminal trace,” in support of the claimed existence of homicidal “gas chambers” in Auschwitz.

Considering these facts, it cannot really be surprising that finally even mainstream historians and media are taking notice of them: In May 2002, Fritjof Meyer, a senior editor at Germany’s largest, left-wing weekly magazine *Der Spiegel*, stated in an article that documents and witness statements regarding the alleged gas chambers in the Crematoria II and III of Birkenau

*“rather indicate that attempts were made in March and April of 1943 to use the mortuary cellars for mass murder in the early summer of 1943. Apparently, the tests were not successful [...] The actually committed genocide probably took place mainly in the two converted farmhouses outside of the camp.”*³²⁹

In other words: there is a tendency to abandon those locations, which Prof. Dr. R. van Pelt called “the absolute center” in the “geography of atrocities” (see page 85), or even the Birkenau crematoria altogether, since, according to Meyer, the genocide is now supposed to have taken place mainly in those ominous farmhouses or bunkers, of which we possess hardly any documentary evidence.

Following Meyer, the final destruction of the corpses of the alleged victims of mass murder is now supposed to have happened almost ex-

³²⁹ F. Meyer, “Die Zahl der Opfer von Auschwitz,” *Osteuropa*, 52(5) (2002), pp. 631-641, here p. 632; for critical reviews of these articles, see Germar Rudolf, “Cautious Mainstream Revisionism,” *The Revisionist*, 1(1) (2003), pp. 23-30; C. Mattogno, “Auschwitz. The new Revisions by Fritjof Meyer,” *The Revisionist*, 1(1) (2003), pp. 30-37; idem, “On the Piper-Meyer-Controversy: Soviet Propaganda vs. Pseudo-Revisionism,” in: *The Revisionist*, 2(2) (2004), pp. 131-139; J. Graf, “‘Just Call Me Meyer’ – A Farewell to ‘Obviousness,’” *ibid.*, pp. 127-130; G. Rudolf, “The International Auschwitz Controversy,” *ibid.*, 2(4) (2004d), pp. 449-452.

clusively by means of open-air incinerations in deep pits. However, all claims made regarding the alleged open-air incineration of corpses in deep pits are obviously untrue, because no traces of such incinerations can be found on contemporary air photos, and because the high water table in Birkenau would have prevented the maintenance of fires in deep pits.

Those readers who take no interest in the chemical problems relating to the alleged “gas chambers” in Auschwitz may skip the following chapters 6-8. Prior to a solution to the problem of how the poisonous preparation was introduced into the presumed “gas chambers,” further speculation as to the manner and method of the murders, and their possible chemical traces, remains a mere academic exercise, with no basis in reality. Our study of Auschwitz could, therefore, conclude here.

However, because the chemical questions involved attracted so much attention, caused the hottest controversies, and stirred the most intensive debates, detailed remarks are nevertheless in order about the chemical questions raised, first by Faurisson and Leuchter, relating to the formation of residues (Iron Blue) caused by chemical reactions of hydrogen cyanide.

6. Formation and Stability of Iron Blue

6.1. Introduction

Hundreds of thousands of people are claimed to have been killed in the alleged Auschwitz “gas chambers” by hydrogen cyanide in the form of the product *Zyklon B*[®]. The question which now arises is the following: could this poisonous gas leave chemical traces which could perhaps be detected in these alleged chemical slaughterhouses?

If hydrogen cyanide (HCN), the reactive compound in *Zyklon B*, were only bound to the walls by adsorption (adhesion),³³⁰ there would be no detectable residues left today, because hydrogen cyanide is highly volatile (boiling point: 25.7°C); all the hydrogen cyanide involved would long since have evaporated.

But if one assumes that the hydrogen cyanide, during fumigation, would combine with certain materials in the masonry to create other, considerably more stable compounds, then one might anticipate the possible existence of chemical residues even today.

The reaction products of interest to us in this respect are the salts of hydrogen cyanide, called cyanides,³³¹ of particular interest here are iron cyanides formed by the reaction of iron compounds with HCN. Iron occurs universally in nature. It is iron which gives brick its red color, sand its ochre color, and clay its color ranging from yellowish to reddish-brown. More precisely, we are speaking of iron oxide, popularly known as “rust.” Basically, all walls consist of at least 1% rust, as a result of sand, gravel, clay and cement, of which the wall is constructed.

Iron cyanides have long been known for their extraordinary stability. One of them has achieved particular fame as one of the most commonly used blue pigments during the last three centuries: Iron Blue, also often referred to as Prussian Blue.

³³⁰ *Absorption* and *adsorption* are not the same! *Absorption* is the incorporation (sometimes even consumption) of a matter into a medium (light is absorbed/consumed by a pigment, gas is absorbed/dissolves into a liquid), whereas *adsorption* is the adhesion of matter onto a – usually solid – surface (dust on furniture, steam on windscreen, vapours on any solid surface...); *Adsorption* is further subdivided into *chemisorption*, in which the matter is bound to a surface by chemical bonds, and *physisorption*, in which the bonding is only a physical effect. The transition between both is fluent.

³³¹ For simplicity's sake, “cyanide” is frequently understood to mean only the anionic part of the cyanide salts, the cyanide ion, CN⁻.

6.2. Instances of Damage to Buildings

Chapter 1.3. contained a discussion of two instances of damage to churches which occurred in the 1970s in Bavaria, Germany. In the many hundreds of thousands of fumigations which have been carried out since 1920, there cannot, as a rule, have been any complications. Otherwise the procedure would have been very rapidly abandoned. The cases in question were, therefore, exceptions. But what exactly was it that made these churches exceptions?

Different scenery. 1939-1945. In the camps of the Third Reich, hundreds of thousands of people – Jews, political prisoners, criminals, “anti-socials,” and prisoners of war – were crammed together. To stem the raging epidemics, attempts were made, not always with great success, to kill the carriers of disease, particularly head lice. This was done in particular with hydrogen cyanide, Zyklon B, which was sometimes applied in chambers professionally designed for such purposes. But sometimes only ordinary rooms were equipped for such purposes in an auxiliary manner and temporarily used for disinfestation. Many of the camps in the Third Reich were leveled at the end of the war or afterwards; in other camps, the existing buildings were torn down and the building materials used for the repair of old buildings or for the reconstruction of new ones. A few buildings, however, remain intact to this very day. The interiors of these buildings look as in Fig. 59-66 (see the color pictures at www.vho.org/GB/Books/tr/6.html#6.2. & [.../8.html#8.3.3.3.](http://www.vho.org/GB/Books/tr/8.html#8.3.3.3.)).

From the remarks of a team of Polish researchers who conducted investigations on behalf of the Auschwitz Museum, we also know that the disinfestation chamber in the Auschwitz main camp is colored a spotty blue.^{61,62} To my knowledge, only the Zyklon B disinfestation chambers of Dachau camp (Degesch circulation chambers) exhibit no blue pigmentation, probably because the walls were professionally coated with a paint impermeable to gas and water.



Fig. 59: Interior northwest room in the Zyklon B disinfestation wing of BW 5a in the Birkenau camp.

(© Karl Philipp)



Fig. 60: Exterior southwest wall of the Zyklon B disinfestation wing of BW 5b in the Birkenau camp.

(© Karl Philipp)



Fig. 61: Zyklon B disinfestation installation, chamber III, of barrack 41 in Majdanek camp. (© C. Mattogno³³²)



Fig. 62: Zyklon B disinfestation installation, east wall of chamber III of barrack 41 in Majdanek camp. (© C. Mattogno³³²)



Fig. 63: Large Zyklon B disinfestation chamber, ceiling, barrack 41 in Majdanek camp. (© C. Mattogno³³²)



Fig. 64: Zyklon B disinfestation installation, chambers II and III (exterior wall), of barrack 41 in Majdanek camp. (© Carlo Mattogno³³³)

It seems therefore that a blue pigmentation of masonry is no exception, but rather a rule, particularly where unprotected masonry is repeatedly exposed to hydrogen cyanide over long periods. The large-scale, long-term use of hydrogen cyanide for vermin control in disinfestation chambers only began, in practice, with the onset of the Second World War. And with the dissolution of the National Socialist camps, the confiscation of the corporation having manufactured and marketed Zyklon B (the *I.G. Farbenindustrie AG*), and the invention of DDT at the end of World War II, this large-scale use of hydrogen cyanide ended just as abruptly. No one cared about any “instances of building damage” having occurred in the former National Socialist disinfestation chambers in this period. The question never arose in the literature... until Frederick A. Leuchter came along.

The following is an attempt to demonstrate the manner in which these blue pigments, referred to as Iron Blue, came to be formed in the

³³² Taken from the book by Jürgen Graf, Carlo Mattogno, *Concentration Camp Majdanek*, Theses & Dissertations Press, Chicago 2003, photos XIII, XIV, XIX; see also the photo in Michael Berenbaum, *The World Must Know*, Little, Brown & Co., Boston 1993, p. 138.

³³³ Taken from the book by G. Rudolf (ed.), *op. cit.* (note 24), color page, with kind permission by C. Mattogno.



Fig. 65: Zyklon B disinfestation chamber in Stutthof camp, interior view taken from the south door.
(© Carlo Mattogno³³⁴)



Fig. 66: Zyklon B disinfestation chamber in Stutthof camp, east side, exterior. (© Carlo Mattogno³³⁴)

masonry during fumigation with HCN, and the conditions favorable to their formation.

There have been many publications on this chemical compound in the last five decades, which were perused and will be summarized in the following in relation to our topic. In so doing, attention was directed at:

- 1) the circumstances which lead to the formation of Iron Blue, and
- 2) the long-term stability of Iron Blue under the existing circumstances.

When writing the initial versions of this expert report intended to be presented at German courts of law, I was extremely anxious not to make any mistakes, because I knew that the topic was extremely controversial. As a consequence, I over-examined several chemical aspects involved, some of which can be understood only by chemical experts. Others aspects are not really necessary for an understanding of the core issue. In order to have a complete English version of my expert report, I nevertheless decided to include all the material I accumulated over the years. Those sections, however, which are considered of marginal interest or of interest to experts only, I have given headlines always starting with “Excursus.” For some readers it might be advisable to skip these chapters. They will most likely not miss anything.³³⁵

But first a short description of the starting substance, hydrogen cyanide.

³³⁴ Taken from the book by C. Mattogno, J. Graf, *Concentration Camp Stutthof*, Theses & Dissertations Press, Chicago 2003, photos 13 & 14.

³³⁵ I also want to point out that I did not include all this academic, self-serving ivory tower chatter in order to impress people. I was simply advised by many friends, supporters and adversaries to include all my material, since back-references to my German original is not helpful for most English language speakers, of whom only a tiny fraction can read German.

6.3. Properties of Hydrogen Cyanide, HCN

Hydrogen cyanide, a colorless liquid, is similar to water in many of its *physical* properties.³³⁶ This similarity also explains the limitless solubility of HCN in water and its strong tendency towards absorption (dissolution) in water. The equilibrium concentration³³⁷ of hydrogen cyanide in water is investigated in more detail in chapter 6.5.4.

The opinion is often expressed that, because gaseous hydrogen cyanide is approximately 5% lighter than air, it must separate from air and rise. Hydrogen cyanide gas is, however, only slightly lighter than air and does not separate, because of the thermal movement of every gas particle. To clarify this, reference must be made to the principal components of air: The main component of air, nitrogen, 78% by volume, is 8% heavier than hydrogen cyanide gas. If a separation took place between hydrogen cyanide gas and nitrogen, it would all the more occur between the two main components of air, since oxygen (21% of air by volume) is 15% heavier than nitrogen. This would have as a result that all the oxygen of the earth's atmosphere would settle in the lower fifth of the atmosphere, as a consequence of which the entire surface of the earth would get oxidized, *i.e.*, burn. This obviously does not happen. Thus, a spontaneous separation of hydrogen cyanide gas would never take place in air.

Molecular weight	27.026 g mol ⁻¹
Boiling point (1 atm)	25.7°C
Melting point	-13.24°C
Specific density of the gas at 31°C (air = 1)	0.947
Explosion limits in air	6-41 vol.% ³³⁹

However, the lower density of pure hydrogen cyanide gas compared to air (5% less, which corresponds to a density difference of 35°C warm air as compared to 20°C warm air) can very well lead to a density convection, *if* pure gaseous hydrogen cyanide is released in a location with

³³⁶ High polarity, low molecular mass, possibility of formation of hydrogen bonds.

³³⁷ Concentration is the number of parts per volume.

³³⁸ W. Braker, A.L. Mossman, *Matheson Gas Data Book*, Matheson Gas Products, East Rutherford 1971, p. 301. I have left out some of the less interesting dimensions in this connection: heat capacity (20.9°C): 2.625 J g⁻¹ K⁻¹ (Water=4.187 J g⁻¹ K⁻¹); dielectric constant (20°C): 114 (Water=78.5); evaporation heat: 28 kJ mol⁻¹; evaporation entropy: 190 J mol⁻¹ K⁻¹; spontaneous combustion temperature: 538°C; flash point: -17.8°C; regarding dielectric constants, see: R.C. Weast (ed.), *Handbook of Chemistry and Physics*, 66th Ed., CRC Press, Boca Raton, Florida 1986, E 40. However, under normal conditions (1 atm, 25°C), hydrogen cyanide is not a gas.

³³⁹ 1 vol.% is 10,000 ppm (for HCN, roughly 12 g/m³)

the same temperature as the ambient air. The gas would then rise slowly, but gradually mix with the ambient air. But it would be an incorrect to conclude from this that hydrogen cyanide vapors always rise. At 15°C, for example, on physicochemical grounds, no concentrations higher than 65% of hydrogen cyanide can occur in air (see Graph 1); the density of such a mixture lies only approximately 3% below that of air. Furthermore, a great deal of energy is withdrawn from the ambient air by the evaporating hydrogen cyanide. Consequently, the ambient temperature sinks until exactly as much energy is transported to the liquid (adsorbed) HCN as needed for the decelerated evaporation at the corresponding lower temperature. It is therefore theoretically possible for hydrogen cyanide vapors containing little HCN, but which are cold, to be denser, that is heavier, than the ambient air.

Graph 1 shows the equilibrium percentage of hydrogen cyanide in air as a function of temperature. Even at 0°C, the percentage still lies at approximately 36% by volume. Condensation of HCN on surrounding objects would occur only if the percentage rose over the equilibrium percentage (the so-called dew point). Since in all cases here under consideration, a maximum concentration of 10% HCN in air would only be reached for a short period of time close to the source of HCN (the Zyklon B carrier), no condensation of HCN on walls can be expected. An exception is, however, the so-called capillary condensation, which can occur in finely porous materials such as cement mortar.³⁴⁰

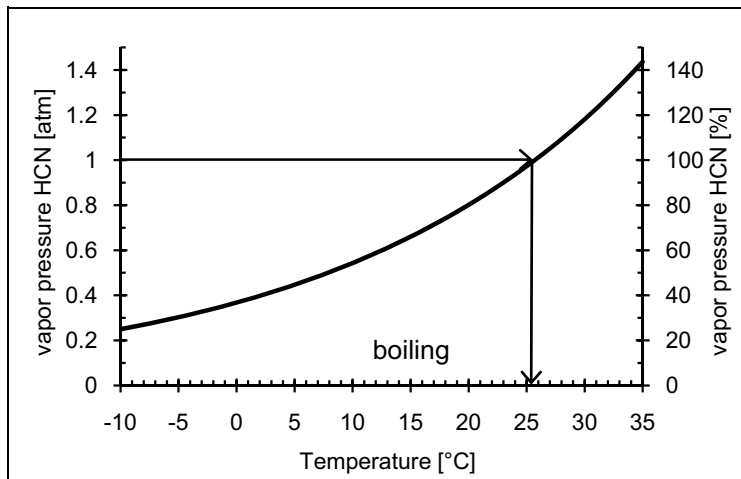

Graph 1: Vapor pressure of hydrogen cyanide in percentage of air pressure as a function of temperature.

³⁴⁰ The lowered vapor pressure caused by adsorption effects in a narrow hollow space leads to early condensation.

Hydrogen cyanide forms explosive mixtures with air in the range of 6 to 41% by volume. With strong initial ignition, its explosive effects can be compared with nitro-glycerin.³⁴¹ In the applications under discussion here, a proportion of 6% by volume and more can be reached in the immediate vicinity of the source, which suffices for local blow ups at the most. Hence, only inappropriately high concentrations can lead to explosive mixtures, as shown by a corresponding accident in 1947.¹⁷ With correct application quantities and concentrations, the technical literature indicates that there is practically no danger of explosion.³⁴²

6.4. Composition of Iron Blue

6.4.1. Overview

The stoichiometric composition of an ideal Iron Blue crystal is:

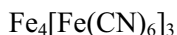

It is characteristic that the iron in this compound is present in two different oxidation states: Fe^{2+} (here in square brackets) and Fe^{3+} (here on the outer left). The interaction between these two different iron ions gives rise to the blue color of this compound (charge-transfer complex). The actual composition can be quite variable, depending on the stoichiometry on formation and the presence of impurities, in which case the color varies between dark blue and greenish-blue tones.

6.4.2. Excursus

It was with support of the Mössbauer spectroscopy³⁴³ that a long-lasting argument could be settled.^{344,345} Turnbull's Blue, $\text{Fe}_3[\text{Fe}(\text{CN})_6]_2$, is actually the same as Berlin Blue, $\text{Fe}_4[\text{Fe}(\text{CN})_6]_3$, even if the summation formulas suggest they are different. As a matter of fact, the summa-

³⁴¹ The usual explosive in dynamite. Cf. Wilhelm Foerst (ed.), *Ullmanns Encyklopädie der technischen Chemie*, vol. 5, Urban und Schwarzenberg, Munich ³1954, p. 629.

³⁴² Willibald Schütz, "Explosionsgefährlichkeit gasförmiger Entwesungsmittel,"

Reichsarbeitsblatt, Teil III (Arbeitsschutz no. 6), no. 17/18 (1943), pp. 198-207, here p. 201.

³⁴³ Impulseless resonance absorption of γ quants (gamma radiation) from a radioactive isotope, here Cobalt: $^{57}\text{Co} \rightarrow ^{57}\text{Fe} + \gamma$ (main quant: 122 keV; quant used for spectroscopy has a different energy).

³⁴⁴ E. Fluck, W. Kerler, W. Neuwirth, *Z. anorg. allg. Chem.* 333 (1964), pp. 235-247; J.F. Duncan, *J. Chem. Soc.* 1963, pp. 1120-1125.

³⁴⁵ H.J. Buser, D. Schwarzenbach, W. Peter, A. Ludi, *Inorg. Chem.* 16 (1977), pp. 2704-2710. Iron Blue single crystals of high purity and homogeneity were obtained by slow oxidation of a solution of $\text{Fe}[\text{Fe}^{\text{II}}(\text{CN})_6]$ in concentrated (!) HCl_{aq} in air. If in the presence of molar amounts of Kalium only some 2% inclusions were observed.

tion formula of Berlin Blue is closest to the reality: In the ideal Iron Blue crystal, up to 16 molecules of coordination water are included:

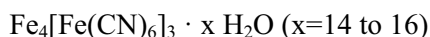

It is known today that the “soluble” Iron Blue, a term frequently found in older literature, is mainly a substance with the composition $\text{MeFe}^{\text{III}}[\text{Fe}^{\text{II}}(\text{CN})_6] \cdot x \text{H}_2\text{O}$, where Me is the counter ion to the opposite cyanoferrate, $[\text{Fe}(\text{CN})_6]^{3-/4-}$, mostly potassium (K^+) or ammonium (NH_4^+).

According to Buser,³⁴⁵ “soluble” Iron Blue is formed mainly during quick formation and precipitation of the pigment, leading to the inclusion of large amounts of water and potassium or ammonium ions in the extremely voluminous precipitate. The resulting crystal is therefore very faulty and more appropriately called a polymer.³⁴⁶ By filtration, drying and intensive grinding, however, this very inhomogeneous, polluted Iron Blue can be transformed into a pigment which is colloidal dispersible only with difficulty.³⁴⁷ This “soluble” Iron Blue is not soluble in the original sense of the word, but can more easily be colloiddally dispersed than the “insoluble” Iron Blue, which is very important for its application as a pigment.^{348,349}

However, these colloids are very unstable and precipitate easily when salts are added.³⁵⁰ According to Buser,³⁴⁵ even in presence of high concentrations of potassium ions, almost pure “insoluble” Iron Blue can be obtained, if the formation process is proceeding slowly enough. In case of deeper interest about the structure one might consult the literature.^{345,351}

³⁴⁶ Originally, this term was used only in organic chemistry for chainlike connected, sometimes also branched attachments of equal segments.

³⁴⁷ *Dispersion* (lat.: dispersere, distribute) are distribution of two different phases within each other. They are called *colloids* (gr.: glue-like) if the particles are between 10^5 and 10^7 m small. Such a mixture in liquids scatters the light (Tyndall effect), is thus not clear. But due to electrostatic repulsion (equally charged particles), colloids do not tend to coagulate and precipitate. *Suspension*: (lat.: to float) are coarsely dispersed system with particle sizes bigger than 10^6 m.

³⁴⁸ R.E. Kirk, D.F. Othmer, *Encyclopedia of Chemical Technology*, Vol. 13, 3. ed., Wiley & Sons, New York 1979, pp. 765-771; J.A. Sistino, in: Peter A. Lewis (ed.), *Pigment Handbook*, Vol. 1, Wiley and Sons, New York 1974, pp. 401-407; A.F. Holleman, N. Wiberg, *Lehrbuch der Anorganischen Chemie*, de Gruyter, Berlin 1001985, p. 1143

³⁴⁹ H. Ferch, H. Schäfer, *Schriftenreihe Pigmente Nr. 77*, Degussa AG, Frankfurt 1990.

³⁵⁰ K.A. Hofmann, *Anorganische Chemie*, Vieweg, Braunschweig 211973, p. 677; B.N. Gosh, K.C. Ray, *Trans. Far. Soc.* 53 (1957), pp. 1659-1661; E.F. Zhel'vis, Y.M. Glazman, *Ukrainskii Khim. Zh.* 35 (1969), pp. 766ff.; *East European Sci. Abs.* 5 (1969), pp. 84f.

³⁵¹ M.B. Robin, *Inorg. Chem.* 1 (1962), pp. 337-342; *Gmelins Handbuch der Anorganischen Chemie*, 59 (Fe), B4, Verlag Chemie, Weinheim 1932, pp. 670-732; R.E. Wilde, S.N. Ghosh, B.J. Marshall, *Inorg. Chem.* 9 (1970), pp. 2512-2516; R.S. Saxena, *J. Ind. Chem. Soc.* 28 (1951), pp. 703-709; A.K. Bhattacharya, *J. Ind. Chem. Soc.* 28 (1951), pp. 221-224.

6.5. Formation of Iron Blue

6.5.1. Overview

We are only concerned, in this connection, with how Iron Blue arises from hydrogen cyanide and iron compounds in building materials. In building materials, the iron is generally present in trivalent form (Fe^{3+}), in the form of “rust.”

For the formation of Iron Blue, therefore, a part of this iron must be reduced to the bivalent form (Fe^{2+}). The subsequent combination of these different iron ions with CN^- to Iron Blue occurs spontaneously and completely.³⁵² The most probable mechanism³⁵³ is one in which the cyanide ion itself acts as a reducing agent. The starting point in so doing is an Fe^{3+} ion, largely surrounded (complexed) by CN^- ions: $[\text{Fe}(\text{CN})_{4-6}]^{(1-3)-}$. A slightly alkaline environment is favorable to the final reduction of the iron(III)-ion to iron(II).³⁵⁴

The pigment formation in the case under consideration proceeds in five steps:

a) Ad-/absorption of hydrogen cyanide (HCN),³³⁰

³⁵² F. Krleza, M. Avlijas, G. Dokovic, *Glav. Hem. Tehnol. Bosne Hercegovine*, 23-24 (1977, Vol. Date 1976), pp. 7-13.

³⁵³ Photolytic decomposition of the $[\text{Fe}^{\text{III}}(\text{CN})_6]^{3-}$ by means of UV radiation is also conceivable as an alternative. Since the interior walls of the rooms in question are not exposed to any UV radiation, this mechanism is ignored here. See also G. Stochel, Z. Stasicka, *Polyhedron* 4(11) (1985), pp. 1887-1890; T. Ozeki, K. Matsumoto, S. Hikime, *Anal. Chem.* 56 (14) (1984), pp. 2819-2822; L. Moggi, F. Bolletta, V. Balzani, F. Scandola, *J. Inorg. Nucl. Chem.* 28 (1966), pp. 2589-2598.

³⁵⁴ pH value of 9-10 according to M.A. Alich, D.T. Haworth, M.F. Johnson, *J. Inorg. Nucl. Chem.* 29 (1967), pp. 1637-1642. Spectroscopic studies of the reaction of hexacyanoferrate(III) in water and ethanol. 3.3×10^{-4} M $\text{Fe}(\text{NO}_3)_3$ were exposed with a cyanide excess of likewise 3.3×10^{-4} mol l^{-1} . With pH values of approximately 10, all the $\text{Fe}_2[\text{Fe}(\text{CN})_6]$ was converted into Iron Blue within 48 hours. Cyanate, the anticipated product of the oxidation of the CN^- , could not, however, be proven. Perhaps this is further oxidized directly into CO_2 . If this mechanism is assumed, the result, purely stoichiometrically, is that an alkaline environment must be favorable. This finding is supported by the known fact that hexacyanoferrate(III) is a strong oxidation agent in alkaline medium and is even able to oxidize trivalent to hexavalent chrome, hence CN^- ions must have oxidized very quickly: J.C. Bailar, *Comprehensive Inorganic Chemistry*, Vol. 3, Pergamon Press, Oxford 1973, p. 1047. An overly alkaline environment would, however, disturb the complexing of the Fe^{3+} -ion by cyanide, which is then displaced by OH^- ($\text{Fe}(\text{OH})_3$) then occurs as a by-product) and/or the latter can hardly be displaced from the iron.

The driving force in the reduction of the Fe^{3+} is the considerably more favorable energetical situation of the hexacyanoferrate(II) as compared to hexacyanoferrate(III); see, in this regard, R.M. Izatt, G.D. Watt, C.H. Bartholomew, J.J. Christensen, *Inorg. Chem.* 9 (1970), pp. 2019ff. Calorimetric measurements relating to the formation enthalpies of Iron Blue from the respective educts (in parentheses) were as follows:

$$\Delta H(\text{Fe}^{2+} + [\text{Fe}(\text{CN})_6]^{3-}) = -66.128 \text{ kJ mol}^{-1}; \quad \Delta H(\text{Fe}^{3+} + [\text{Fe}(\text{CN})_6]^{4-}) = 2.197 \text{ kJ mol}^{-1}.$$

For this reason, a direct reduction of uncomplexed Fe^{3+} , i.e., not surrounded by cyanide, has an energy disadvantage and is therefore negligible.

- b) Ionic splitting (electrolytic dissociation)³⁵⁵ of hydrogen cyanide in water to the cyanide ion, which alone can form complexes with iron;
- c) Complexing of trivalent iron (Fe^{3+}) to the complex iron(III)-cyanide,³⁵⁶ that is, the displacement of oxygen and/or OH^- ions in rust by cyanide ions;
- b) Reduction of iron(III)-cyanide to iron(II)-cyanide;
- e) Precipitation of iron(II)-cyanide with trivalent iron as Iron Blue.

The velocity of formation of the pigment can be influenced by various factors, which will be considered:

1. Water content of the reaction medium;
2. Reactivity of the iron;
3. Temperature;
4. Acidity.

6.5.2. Water Content

6.5.2.1. Overview

The formation of cyanide through absorption and subsequent dissociation of hydrogen cyanide in water is the necessary precondition for a reaction with iron compounds, since hydrogen cyanide itself exhibits only a low reactivity. All reactions listed in chapter 6.5.1. under a)-e) occur almost exclusively in water. Water furthermore ensures that the reaction partners – all salts capable of being dissolved in water – come together in the first place. Finally, the moisture contained in building materials also acts as a hydrogen cyanide trap, since hydrogen cyanide dissolves eagerly in water. A relatively high water content in the masonry will therefore considerably increase the speed of reaction.

6.5.2.2. Excursus

The reason for the low reactivity of HCN compared to the free cyanide ion is because HCN is less nucleophilic than the free ion.³⁵⁷ Aside

³⁵⁵ *Dissociation*: is the splitting of a compound, in this case into two differently charged ions (heterolytic) in aqueous medium (electrolysis):

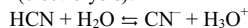

³⁵⁶ Correct: hexacyanoferrate(III).

³⁵⁷ *nucleophilic* (gr.: core/nucleus loving) is the tendency of a particle to react with positively charged particles. For this, at least a partial negative charge of the nucleophilic particle is required. In this case, cyanide is, due to its negative charge (CN^-), much more nucleophilic towards the positively charged iron (Fe^{3+}) than the formally uncharged (though polar) hydrogen cyanide.

from the dissociation of hydrogen cyanide in water, the process of chemisorption³⁵⁰ on solid surfaces deserves being mentioned, where the hydrogen cyanide releases its proton (H^+) to an alkaline oxide and is itself attached to a metal ion.

Absorption and dissociation of the superbly soluble hydrogen cyanide (see chapter 6.5.4.) is clearly superior to chemisorption. Furthermore, the aqueous solution (as solvent) is indispensable for the complex formation and redox reactions of the cyanide with Fe^{3+} . Additionally, the aqueous medium makes the reacting agents mobile, which do not always form at the same location. And finally, the moisture contained in the solid material works as a trap for hydrogen cyanide, because it intensely binds the hydrogen cyanide. Or the other way around: the drier a solid material is, the easier hydrogen cyanide, which was ad-/absorbed before, will be released back into the gaseous phase. Therefore, a relatively high water content of the solid material will accelerate the reaction.

Experiments with reactions of hydrogen cyanide (some 4 g per m^3 in air, 15°C, 75% rel. humidity) with mixtures of $Fe(OH)_2$ - $Fe(OH)_3$ attached to wet paper strips showed that a blue discoloration occurred after 30 min at a pH value³⁵⁸ of 2 to 3, since at such low values almost no hydrogen cyanide dissociates to the reactive cyanide (see chapter 6.5.5.). At pH values of 7 to 9, a visible blue discoloration occurred after a few minutes of inserting the sample. At higher pH values, this time span grew again, because the initially absorbed hydrogen cyanide had to lower the pH value first, before it could form the pigment (see chapter 6.6.1., pH Sensitivity).

These experiments show clearly that undissociated, gaseous HCN or HCN dissolved as gas shows little reactivity. An addition of small amounts of KCN to an aqueous sulfuric acid solution of Fe^{2+}/Fe^{3+} , however, results in the immediate precipitation of the pigment. The cyanide obviously reacts faster with the iron salts than it is protonated by sulfuric acid, *i.e.*, converted into hydrogen cyanide.

³⁵⁸ pH (*pondus hydrogenii* = weight of hydrogen) is a measure for the acid content of aqueous solutions (negative, decadic logarithm of H_3O^+ concentration: $-\lg_{10}(c(H_3O^+))$):
pH < 7: acidic
pH = 7: neutral
pH > 7: alkaline

6.5.3. Reactivity of Trivalent Iron

6.5.3.1. Overview

The solubility of trivalent iron diminishes rapidly with increasing alkalinity (rising pH value). Even in a pH neutral environment, almost all iron is bound as rust.³⁵⁹ The reaction between iron compounds and cyanide resulting in the formation of the intermediate product iron(III)-cyanide, $[\text{Fe}(\text{CN})_6]^{3-}$, is therefore largely a reaction on the solid-liquid interface, that is, between the iron adhering to the solid body and the cyanide ion in solution. This reaction occurs considerably more slowly than the same reaction in an aqueous solution. The fastest possible reaction requires a large surface area on the solid-fluid phase boundary, that is, a large interior, microscopically rough surface and a fine, highly porous solid body, since in such cases, a lot of the iron compounds lie on the surface and are therefore less firmly bound and can relatively quickly combine with cyanide.

In an increasingly alkaline environment, only decreasingly small amounts of “rust” can slowly be converted into iron(II)-cyanide, but cannot react with iron(III)-ions to form Iron Blue.

6.5.3.2. Excursus

Even in an alkaline environment, it must be expected that rust, in the presence of perceptible cyanide concentrations, will be quite slowly transformed into iron(III)-cyanide and finally into iron(II)-cyanide.³⁶⁰ The last step required for the formation of Iron Blue, however, the combination of iron(II)-cyanide with iron(III), will not occur due to the lack of dissolved iron(III)-ions. In a strongly alkaline environment, an increasing concentration of iron(II)-cyanide, which is chemically stable, can slowly accumulate. It remains in a stand-by position, waiting for the pH value to drop.

Iron salts generally tend to incorporate water, and Iron Blue is no exception to this. A higher water content in the solid body results in increased water accumulation in rust, too. The rust expands, so to speak,

³⁵⁹ $\text{Fe}_2\text{O}_{(3-x)}(\text{OH})_{2x} \cdot x \text{H}_2\text{O}$

³⁶⁰ Naturally, the equilibrium of the reaction $\text{Fe}(\text{OH})_3 + 6 \text{CN}^- \rightleftharpoons [\text{Fe}(\text{CN})_6]^{3-} + 3 \text{OH}^-$ under such conditions is strongly on the left hand side. However, this does not mean, as is well known, that a minute quantity of iron(III)-cyanide will not be formed. The latter, however, is withdrawn from the equilibrium in alkaline medium in the presence of excess cyanide, by being reduced by the latter to iron(II)-cyanide, which is considerably more stable in alkaline medium than iron(III)-cyanide; for further details, see also chapter 6.6.1.

and thus becomes more reactive towards competing ligands³⁶¹ like cyanide. Freshly precipitated, extremely moist and non-homogenous iron hydroxide is very reactive, and together with hydrogen cyanide, as shown in chapter 6.5.2.2., they form the pigment in visible quantities in minutes.

For the formation of colloiddally dispersible Iron Blue, the quick formation in aqueous solution with high concentrations of the agents is required (see chapter 6.4.2.), since this leads to heterogeneous crystallites (tiny crystals) with many inclusions (ions, solvent molecules) and a high degree of disorder. These crystallites have only a small tendency to coagulate.

The slow interface reaction at the liquid-solid interface with quite low concentrations of the reacting agents will suppress the formation of colloiddally dispersible Iron Blue. The process described here, occurring in walls exposed to hydrogen cyanide, strongly resembles the formation of monocrystals as described by Buser,³⁴⁵ since in this case also, one reagent (Fe^{2+}) had to be formed through slow reduction by excess cyanide. Thus, except from the inhomogeneous material, the conditions here under consideration are suitable for a slow crystal growth of insoluble Iron Blue without large amounts of inclusions and with formation of few crystal defects.

6.5.4. Temperature

6.5.4.1. Overview

The environmental temperature has an influence on the following processes and features:

- A) Accumulation of hydrogen cyanide in the moisture of the masonry;
- B) Water content of the solid body;
- C) Velocity of reactions.

A: Graph 2 shows the maximum solubility of HCN in water at various temperatures with a hydrogen cyanide content of 1 mol% in air,³⁶² which corresponds to approximately 13 g hydrogen cyanide per m^3

³⁶¹ In complex chemistry, *ligands* refer to in most cases negatively charged particles (anions) surrounding in most cases a positively charged central particle (cation, in general a metal ion). In this case, the central atom iron ($\text{Fe}^{2+/3+}$) is surrounded by the ligand cyanide (CN^-).

³⁶² *mol* is a standard amount of particles: $1 \text{ mol} = 6.023 \times 10^{23}$ particles, according to the definition, the number of atoms contained in 12 g Carbon.

air.³⁶³ It increases, as with any gas, with decreasing temperature and lies between 0.065 mol per liter at 30°C and 0.2 mol per liter at 0°C.

These high concentrations prove the extreme solubility of hydrogen cyanide in water.³⁶⁶ It decreases by approximately half every 20°C. It is therefore

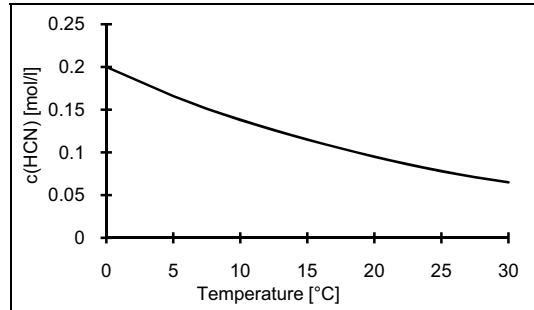

Graph 2: Saturation concentration of hydrogen cyanide in water as a function of temperature at 1 mol% HCN in the air (partial pressure³⁶⁴ of $p(\text{HCN})=0.01$).

approximately 10,000 times more soluble in water than oxygen (O_2) and approximately 250 times more soluble than carbon dioxide (CO_2).³⁶⁵

B: The moisture content of masonry is very strongly dependent on the relative humidity of the surrounding air and the temperature. With rising temperature, the tendency of water to evaporate (water vapor pressure) increases, whereas, as a rule, the relative humidity of the air decreases. Both effects lead to a drop in the water content; any increase in the temperature has therefore a cumulative effect. Drops in water content by a power of ten at temperature increases of 10°C have been proven in the temperature ranges of 10-30°C under consideration (see chapter 6.7.).

C: Only an acceleration in the slowest of the five steps described in chapter 6.5.1. can be responsible for a change in the velocity of the entire reaction. In neutral or alkaline medium, this is the displacement of the oxygen or OH^- -ion in rust by the cyanide ion (point c). Although the iron(III)-cyanide $[\text{Fe}(\text{CN})_6]^{3-}$ itself is stable in a moderately alkaline medium³⁶⁶ – that is, the iron(III)-cyanide is more stable than the rust – the displacement of OH^- by cyanide ions is inhibited in rust, since the rust is not dissolved in water. An increase in temperature by 20°C usually doubles the velocity of reaction, if the other parameters remain unchanged. But they are not unchanged, because the massively decreased water content at higher temperatures (see above) leads to a dras-

³⁶³ Landolt-Börnstein, *Eigenschaften der Materie in ihren Aggregatzuständen*, part 2, volume b, *Lösungsmittelgleichgewichte I*, Springer, Berlin 1962, pp. 1-158.

³⁶⁴ The partial pressure of a gas is its fraction of the total gas content; e.g., 10 mbar HCN at 1,000 mbar total pressure.

³⁶⁵ See also www.engineeringtoolbox.com/gases-solubility-water-d_1148.html.

³⁶⁶ See also J.C. Bailar's remarks on the massive reduction force of $[\text{Fe}(\text{CN})_6]^{3-}$ in the alkaline environment, *op. cit.* (note 354).

tic decrease of the reaction partner's mobility, of the reactivity of iron, and higher temperatures also result in a lower concentration of ad-/absorbed hydrogen cyanide (see chapters 6.5.2. and 6.5.3.). A strong reduction in pigment formation must therefore be expected at increased temperatures.

A decisively higher water content of the solid material and the considerably better absorption and solubility properties of hydrogen cyanide in water are the reasons for the tendency of solid materials to accumulate more cyanides with lower temperatures. An increase in the reactivity of iron oxide (rust) in the solid body with relation to hydrogen cyanide with a higher water content of the solid material at lower temperatures must be anticipated, as well as with a general increase in the reactivity of all agents. A cooler, and thus moister, solid material is therefore better suited to the formation of Iron Blue than a warm, dry body.³⁶⁷

6.5.4.2. Excursus

There are two more steps in the observed reaction which could, theoretically, have an influence on the reaction under consideration:

- A) Adsorption on the solid material;
- B) Dissociation of hydrogen cyanide.

A: The adsorption of hydrogen cyanide on solid surfaces decreases with rising temperature, according to Langmuir (see Graph 3).³⁶⁸

$$\Theta = \frac{\frac{K}{\sqrt{T}} \cdot p \cdot e^{-\Delta H/RT}}{1 + \frac{K}{\sqrt{T}} \cdot p \cdot e^{-\Delta H/RT}} \quad (1)$$

Θ = Degree of adsorption
 K = variable
 ΔH = adsorption enthalpy (negative)
 R = universal gas constant
 e = Euler's number (2.71828...)
 T = temperature
 p = gas pressure

The intensity of the decrease of the equilibrium degree of adsorption (coverage) with rising temperature as well as the point of approximate saturation, however, are unknown for the problem at hand. But since, as discussed before, all reactions under consideration require aqueous solutions anyway, adsorptions on solid, *i.e.*, dry surfaces are of no importance to our investigation.

³⁶⁷ Needless to say, in the immediate vicinity and beyond the freezing point of water, the reactivity drops precipitously.

³⁶⁸ J. Oudar, *Physics and Chemistry of Surfaces*, Blackie & Son, Glasgow 1975, pp. 26ff.

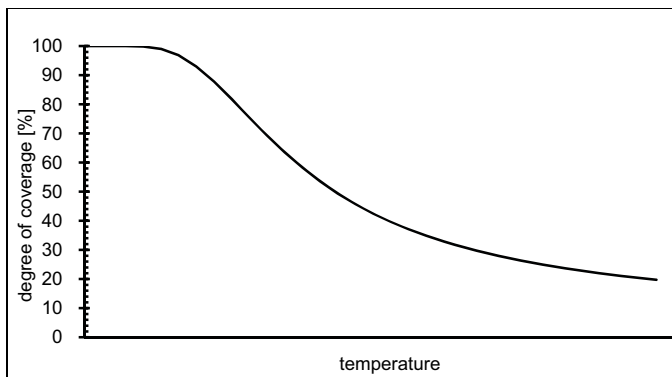

Graph 3: Degree of coverage of the surface of a solid material with an adsorbed gas as a function of temperature (schematic)

B: According to the literature, the dissociation behavior of acids as a function of temperature is not unanimous.³⁶⁹ Although a tendency of increasing protolysis³⁷⁰ prevails with rising temperature, this tendency turns upside down at higher temperatures for some acids, others show generally falling values. Since the changes are generally in the range of low percentages only, and because speed of protolysis is generally very high anyway, hence never a restricting factor, this can be neglected here.

6.5.5. Alkalinity

The pH value (acidity or alkalinity) influences the formation in various ways. In chapter 6.5.1., reference was already made to the higher reduction power of cyanide and iron(III)-cyanide in alkaline environment. The pH value also influences the reactivity of iron compounds in the solid body (chapter 6.5.3.).

As remarked above, dissolved hydrogen cyanide hardly exhibits reactivity. The formation of cyanide ions by absorption and dissociation of hydrogen cyanide only starts in sufficient degree at neutral pH values and above, see Graph 4.³⁷¹ The data leading to Graph 4, together with the data that enabled us to plot Graph 2 (saturation concentration of HCN as a function of temperature), leads to a graph revealing the relationship between temperature, pH value (acid content), and CN⁻ satura-

³⁶⁹ R.C. Weast (ed.), *op. cit.*, (note 338), p. D 163.

³⁷⁰ Protolysis is the splitting of acids (HAc) into their corresponding acid anion (base, Ac⁻) and proton (H⁺, or with water to H₃O⁺):

$$\text{HAc} + \text{H}_2\text{O} \rightleftharpoons \text{Ac}^- + \text{H}_3\text{O}^+$$
 here:
$$\text{HCN} + \text{H}_2\text{O} \rightleftharpoons \text{CN}^- + \text{H}_3\text{O}^+$$

³⁷¹ pK_A values of HCN: 9.31; R.C. Weast (ed.), *op. cit.* (note 369).

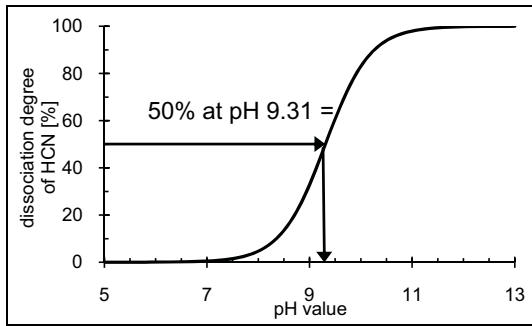

Graph 4: Degree of disassociation of hydrogen cyanide as a function of the pH value at room temperature.

tion concentration, see Graph (p. 156; at a concentration of 1 mol% HCN in air, which is approximately 1% by weight, the usual disinfection concentration).³⁷² At neutral pH values, equilibrium concentrations of CN^- are within the range of 3×10^{-4} to 1×10^{-3} mol per liter, depending on the temperature. An increase in the pH value by one point results in a ten-fold increase in the cyanide equilibrium concentration. The actual cyanide concentration in masonry is determined by the velocity of absorption of the gas, adsorption effects within the solid material, and possible reactions of the cyanide.

6.5.6. Carbon Dioxide

Carbon dioxide (CO_2) is a natural trace gas, today making up some 0.04% of earth's atmosphere. Since some four to five percent of our exhaled breath consists of carbon dioxide, enclosed spaces used by humans frequently contain considerably more carbon dioxide than fresh air, depending on how well they are ventilated. In the cases under consideration, no ventilation would have taken place at all for an extended period of time in a room packed full of people. Hence the CO_2 content could have risen to several percent relatively fast.³⁷³

CO_2 dissolves in water roughly 250 times less than HCN and only reluctantly reacts with water to form carbonic acid (H_2CO_3). As a result, CO_2 has an effective acidity which is roughly 870 times stronger than

³⁷² Valid for ideal solutions.

³⁷³ Chapter 7.3.1.3.2., p. 196, contains an indirect indication of the CO_2 content, as it is basically the difference between the baseline O_2 concentration in the atmosphere (21%) and the actual O_2 concentration.

HCN.³⁷⁴ Hence CO₂ is effectively $\left(\frac{870}{250}\right)$ 3.5 times “stronger” than HCN. This means that plain water saturated with both CO₂ and HCN would slow down the dissociation of HCN and hence the formation of cyanide salts.

The situation is different in the capillary water of mortar and concrete, though, as this is not plain water. Since calcium carbonate is a main (lime mortar) or at least a sizeable constituent (cement mortar & concrete) of these materials, the capillary water in them is saturated with calcium and the various dissociation levels of carbonic acid, including CO₂, depending on the prevailing acidity of the respective material (see chapter 6.7. for details). Hence adding any CO₂ to the surrounding atmosphere can shift the existing equilibrium only marginally and slowly by CO₂ slowly diffusing into the wall’s capillaries. For saturated calcium carbonate solutions, this diffusion of CO₂ and any other gaseous compound, HCN included, is hampered, however, by the precipitation of calcium carbonate at the air-water interface. This effect is stronger, the more alkaline the capillary water is, as this raises the equilibrium concentration of carbonate. This is the basis for the long-term stability of reinforced concrete, whose capillary water stays alkaline over long periods of time even in the presence of larger amounts of

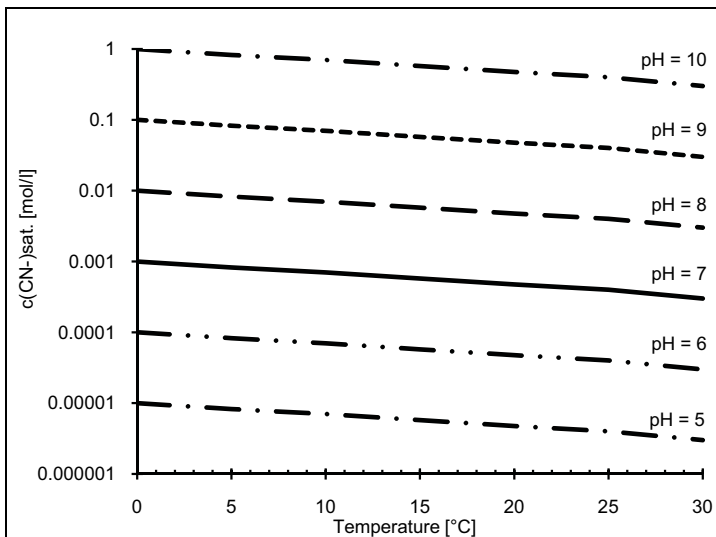

Graph 5: Cyanide equilibrium concentration in water as a function of the temperature and pH value at 1mol-% HCN in the air.

³⁷⁴ $pK_a(\text{HCN}) = 9.31$; $pK_{a1}(\text{CO}_2/\text{H}_2\text{CO}_3) = 2.77$; $pK_{a1}(\text{H}_2\text{CO}_3/\text{HCO}_3^-) = 3.6$; $pK_{a1}(\text{CO}_2/\text{HCO}_3^-) = (2.77+3.6) = 6.37$; $pK_{a2}(\text{HCO}_3^-/\text{CO}_3^{2-}) = 10.25$; see http://en.wikipedia.org/wiki/Carbonic_acid

CO₂. This alkalinity provides an effective corrosion protection via passivation of the reinforcement iron bars, which would otherwise rust, expand, and burst the concrete cast around it (see chapter 6.7.2. for more details).

In contrast to this, there is, thermodynamically speaking, nothing which prevents HCN added to the atmosphere from diffusing into the capillaries. However, the above mentioned thin solid film of calcium carbonate at the air-water interface will slow down the diffusion of any compound through this air-water interface. This barrier works both ways, as it slows down both the accumulation of HCN in the capillary water as well as its later loss, when the surrounding air does no longer contain HCN. Since CO₂ is naturally present to some degree in enclosed spaces frequented by humans under any circumstances, its presence will continue acting as a diffusion barrier even after ventilation of the room. Hence the dominating effect of CO₂ in a room should be that it traps HCN in the capillaries, once it has managed to diffuse into them. This trapping effect should be stronger, the more alkaline the wall is, all the more so as an alkaline environment also supports the dissociation of HCN and thus the formation of cyanides.

High concentration of CO₂ will considerably accelerate the setting of fresh lime mortars and will decrease the pH value of their capillary water, until the equilibrium pH of ca. 7 of saturated calcium carbonate solutions is reached, with the resulting effects of this lower pH value (see chapter 6.5.5.). This effect is much less pronounced and much slower in cement mortars and concrete, which exhibit a different chemistry (see chapter 6.7.2.).

This issue is of importance, because the opinion is sometimes expressed in the literature that the carbon dioxide content of air can have a decisive negative influence on the formation of cyanide salts in wall material.^{62,68,70} This is done under the assumption that the capillary system is filled with pure water, which is not the case, though.

The only data available so far are contradictory and due to a flawed method of analysis not really of any value (see chapter 8.4.2.). Appropriate experiments are therefore required to settle this issue by quantifying the influence of CO₂ under realistic conditions.

6.5.7. Conclusion

The result of all factors which can currently be quantified is that slightly alkaline pH values are favorable to the formation of the pigment.

The individual parameters and their influence on the formation of Iron Blue are summarized in the following table:

Table 4: Factors Influencing the Formation of Iron Blue

Parameter	Effect
Water content	Increase in water content results in the following: increased absorption of hydrogen cyanide; long-term retention of ad-/absorbed hydrogen cyanide; increased mobility of reaction partners; increased reactivity of iron oxide; water is the basic precondition for disassociation and redox reactions; generally positive influence with increasing water content. The water content is dependent above all upon the temperature.
Reactivity of the iron	Factor determining reaction velocity, apart from the type of material and pH value (see below), positively influenced by increasing water content.
Temperature	Increased ad-/absorption of hydrogen cyanide as well as – under otherwise identical conditions – decreased velocity of individual reactions with falling temperature; strong increase on water content, and therefore a strongly positive net influence upon all other factors with a falling temperature.
pH value	Increased iron reactivity with falling pH, as well as a massive reduction in cyanide accumulation and redox reactivity of iron(III)-cyanide; compromise between iron reactivity and cyanide formation/Fe ³⁺ reduction: A weakly alkaline pH value is favorable to absorption of hydrogen cyanide and accumulation of cyanide as well as for the reduction in iron(III)-cyanide, which determines the velocity of the reaction. Although more strongly alkaline media can accumulate iron(II)-cyanide over longer periods of time, no Iron Blue can form under such circumstances. An extremely high pH value fixates iron(III) as hydroxide and hence impedes the formation of any iron cyanides.
CO₂	CO ₂ lowers the pH value and therefore inhibits the formation of cyanides. Especially in alkaline walls it leads to the formation of insoluble CaCO ₃ films at the air-water interface, which slows the diffusion of HCN both into and out of the capillaries. Once in the capillaries, HCN and cyanides hence get trapped , which supports the formation of iron cyanides.

6.6. Stability of Iron Blue

6.6.1. pH Sensitivity

Iron Blue is an extremely acid-resistant, but base-decomposing pigment.³⁷⁵ Hydrogen cyanide is released from this pigment only by warm, diluted sulfuric acid, while cold hydrochloric acid, by contrast, has no effect.³⁷⁶ In a clearly alkaline environment, *i.e.*, in the presence of high concentrations of OH⁻ ions, these displace the cyanide ion from the iron(III)-ion. Fe(OH)₃ is then precipitated (“rust sludge”), and the Iron Blue is destroyed.³⁷⁷

The literature contains authenticated cases of studies with Iron Blue at pH values of 9 and 10, in which it is still stable.³⁷⁸ The pH range around 10 to 11 can be considered the critical limit for the stability of this pigment. Based on the alkaline behavior of fresh mortar and concrete (in this regard, see also chapter 6.7.2), Iron Blue is only used to paint these surfaces to a limited extent.³⁷⁹

³⁷⁵ The hexacyanoferrate acids are very strong acids: J. Jordan, G.J. Ewing, *Inorg. Chem.* 1 (1962), pp. 587-591. The findings of analyses of disassociation constants show, for hexacyanoferrate(III): $K_1^{III} > K_2^{III} > K_3^{III} > 0.1$; hexacyanoferrate(II): $K_1^{II} > K_2^{II} > 0.1$; $K_3^{II} = 6 \times 10^{-3}$; $K_4^{II} = 6.7 \times 10^{-5}$. Thus, hexacyanoferrate(III) is still almost completely disassociated at pH=1, hexacyanoferrate(II) doubly, from pH=3 triply, from pH=5 complete.

³⁷⁶ G.-O. Müller, *Lehrbuch der angewandten Chemie*, vol. I, Hirzel, Leipzig 1986, p. 108; the pigment is, however, reversibly soluble in concentrated hydrochloric acid, *i.e.*, the pigment is not decomposed, but merely physically brought into solution; there is therefore no release of hydrogen cyanide; see also H.J. Buser *et al.*, *op. cit.* (note 345); see also chapter 8.2.: analytical method for total cyanide content according to DIN: the pigment is destroyed by boiling HCl_{aq}. Iron Blue suspensions (see note 347) have an acid pH value of approximately 4. At this slightly acid *eigen* pH, as is formed, for example, by acid rain in surface waters, Iron Blue is at its most stable: H. Ferch, H. Schäfer, *op. cit.* (note 349). In technical applications, the alkaline resistance is increased by adding nickel, cf. R.E. Kirk, D.F. Othmer, *op. cit.* (note 348); J.A. Sistino, *op. cit.* (note 348); E. Elsermann, *Deutsche Farben-Z.* 5 (1951), pp. 419ff.; R. Beck, *Deutsche Farben-Z.* 6 (1952), p. 231.

³⁷⁷ Iron(III)-hydroxide is even less soluble in this range than Iron Blue; on the solubility of Fe(OH)₃ see chapter 6.6.3.; to be exact, Iron Blue is not totally destroyed at a high pH; rather, the Fe³⁺ is, initially, merely withdrawn; the base-resistant [Fe(CN)₆]⁴⁻ remains intact; see note 360.

³⁷⁸ See the studies by M.A. Alich *et al.*, *op. cit.* (note 354).

³⁷⁹ J.A. Sistino, *op. cit.* (note 348); H. Beakes, *Paint Ind. Mag.* 69(11) (1954), pp. 33f. Mixtures of Iron Blue and phtalocyanine blue generally find application, since both, alone, lack sufficient long-term stability; Degussa describes the lime fastness of Iron Blue as “*not good*” (H. Ferch, H. Schäfer, *op. cit.* (note 349)); however, Degussa is referring to its fastness on still uncarbonated, alkaline plasters and concretes: H. Winkler, Degussa AG, letter to this author, June 18, 1991. My own experiments with the dissolution of fresh Iron Blue precipitations resulted in a threshold value of pH 10-11 for the stability of Iron Blue.

6.6.2. Solubility

6.6.2.1. Overview

Iron Blue is considered one of the least soluble cyanide compounds, which is the precondition for its widely-varied application as a pigment.³⁸⁰ The literature flatly refers to Iron Blue as “insoluble.”³⁸¹

Concrete, reliable values on the solubility of Iron Blue are not recorded in the scientific literature. However, based on comparative calculations between the known solubility of $\text{Fe}(\text{OH})_3$ on the one hand, and the threshold value of the pH stability of Iron Blue on the other hand (pH 10), the approximate solubility of Iron Blue in water can be calculated (see chapter 6.6.2.2.). It amounts to ca. 10^{-24} g Iron Blue per liter of water, this means that 0.000000000000000000000001 g Iron Blue dissolves in 1,000 g of water.

In addition to a compound's solubility in water, its condition (crudely or finely crystalline, superficially adherent or adsorbed by capillary effects) as well as, in particular, the condition and quantity of the water supplied are decisive in determining the actual velocity of dissolution of a substance. Iron Blue formed in masonry will be present in a fine crystalline form and adsorbed by capillary effects, in which case the former favors dissolution, while the latter is extremely detrimental to dissolution. Water almost or entirely saturated with iron(III)-ions is no longer capable of dissolving further iron. Furthermore, water permeation through finely porous solid material like masonry is extremely low even at high water tables; the iron saturation concentration is quickly attained, which, in addition, as remarked above, is generated by the slightly more soluble iron oxides of the solid body rather than by the Iron Blue, once it has formed. It is furthermore very well known that mortar and concrete permeated with paints practically cannot be rendered colorless.³⁸² It must, therefore, be anticipated that the Iron Blue content formed in walls cannot be perceptibly reduced by dissolution in

³⁸⁰ This property was used in Soviet industry, for example, for the passivation of steel pipes against aggressive waste waters, since CN^- contained in waste waters coats the interior of pipes with an insoluble protective layer of Iron Blue: N.G. Chen, *J. Appl. Chem. USSR*, 74(1)(1974), pp. 139-142. But it should be noted that this borders on criminal negligence, since toxic cyanides simply do not belong in waste waters.

³⁸¹ DIN Safety Data Sheet VOSSEN-Blau[®], in: *Schriftenreihe Pigmente Nr. 50*, Degussa AG, Frankfurt 1985; see also H. Ferch, H. Schäfer, *op. cit.* (note 349). Last but not least, pigments, by definition, are coloring agents practically insoluble in dissolvents and binding agents (DIN 55,943 and 55,945).

³⁸² See also, in this regard, the remarks of a company dealing in colored cements and concretes: William H. Kuenning, *Removing Stains from Concrete*, The Aberdeen Group, Addison, IL, 1993; cf. www.allstudies.org/search.php?q=Removing%2BStains%2Bon%2BConcrete

water. Water running down the exterior surfaces is considerably more aggressive, exerting, in particular, an erosive effect, *i.e.*, damaging the masonry as such.

6.6.2.2. Excursus

Tananaev *et al.*³⁸³ examined the solubility of metal hexacyanoferrate(II) and discovered a solubility product³⁸⁴ of $3 \cdot 10^{-41}$ ($pK_S = 40.5$) for the solubility product of Iron Blue, without mentioning the unit used.

Assuming they used the summation formula of $Fe_4[Fe(CN)_6]_3$ (unit being $mol^7 l^{-7}$), one attains a solubility of 0.5 mg per liter water. Thus, it would be 14 times less soluble than the nearly insoluble calcium carbonate ($CaCO_3$, 7.1 mg per liter water, $K_S = 4.95 \cdot 10^{-10} mol^2 l^{-2}$).³⁸⁵ Later publications support these findings,³⁵² although attention must be paid to deviations in the stoichiometry (composition) of Iron Blue with impurities, leading to an increased solubility.

Tananaev *et al.* precipitated the complex metal cyanoferrate from an appropriate metal salt solution with $Li_4[Fe(CN)_6]$, probably acquiring a high rate of inclusions (lithium, water) as well. Thus, in spite of the four hour-long accumulation of the precipitation, the filtrate would certainly still have contained colloiddally dispersed Iron Blue. Since they finally determined the amount of free Fe^{3+} in the filtrate by precipitating it with ammonia as $Fe(OH)_3$, they will undoubtedly also have precipitated the Fe^{3+} of the colloiddally dispersed Iron Blue, as ammonia raises the pH value so much that Iron Blue is no longer stable (see chapter 6.6.1.).

Therefore, they probably did not determine the solubility of Iron Blue, but the measure of stability of the dispersion of fresh precipitations of the pigment.

The solubility product of $Pb_2[Fe(CN)_6]$ given by Krleza *et al.*,³⁵² which they used as a reference to determine the solubility products, is much lower than the one used by Tananaev *et al.*. If applied to Tananaev's calculations, this produces a solubility of Iron Blue of only 0.05 mg per liter. Krleza *et al.*, however, find similar results for the solubility of most of the metal cyanides analyzed, including Iron Blue. Since conventional methods of analysis, such as gravimetry and titration, tend to

³⁸³ I.V. Tananaev, M.A. Glushkova, G.B. Seifer, *J. Inorg. Chem. USSR*, 1 (1956), pp. 72ff.

³⁸⁴ The *solubility product* of a compound is defined as the product of the entire ionic concentration of the totally dissociated compound: $Fe_4[Fe(CN)_6]_3 \rightleftharpoons 4 Fe^{3+} + 3 [Fe(CN)_6]^{4-}$;
 $K_L(Fe_4[Fe(CN)_6]_3) = c(Fe^{3+}) \cdot c(Fe^{3+}) \cdot c(Fe^{3+}) \cdot c(Fe^{3+}) \cdot c([Fe(CN)_6]^{4-}) \cdot c([Fe(CN)_6]^{4-}) \cdot c([Fe(CN)_6]^{4-})$
 $= c^4(Fe^{3+}) \cdot c^3([Fe(CN)_6]^{4-})$.

The pK_S value correlates to the negative decimal logarithm of the product of solubility.

³⁸⁵ R.C. Weast (ed.), *op. cit.*, (note 338), p. B 222.

Table 5: Dissociation constants and solubility products of iron compounds

Compound	Constant	Source
$K_S(\text{Fe}_4[\text{Fe}(\text{CN})_6]_3)$	$4.1 \times 10^{-187} \text{ mol}^7 \text{ l}^{-7}$	calculated
$K_{D(6)}([\text{Fe}(\text{CN})_6]^{4-})$	$10^{-24} \text{ mol l}^{-1}$	386
$K_{D(6)}([\text{Fe}(\text{CN})_6]^{3-})$	$10^{-31} \text{ mol l}^{-1}$	386
$K_S(\text{Fe}(\text{OH})_2)$	$4.79 \times 10^{-17} \text{ mol}^3 \text{ l}^{-3}$	385
$K_S(\text{Fe}(\text{OH})_3)$	$2.67 \times 10^{-39} \text{ mol}^4 \text{ l}^{-4}$	385
$K_S(\text{FeCO}_3)$	$3.13 \times 10^{-11} \text{ mol}^2 \text{ l}^{-2}$	385

be unreliable when facing minute traces, one must but wonder about these similar results.

However, one can escape this dilemma by thoughtful reasoning.

It is safe to say that Iron Blue is stable at a pH value of 7, *i.e.*, in a neutral aqueous medium, so we take this as a minimum value. As mentioned earlier, a pH value of about 10 can be considered the upper limit of stability for Iron Blue, so we take this as maximum value for the following calculations. At pH=7, and even more so at pH=10, the free iron concentration is extremely low, since $\text{Fe}(\text{OH})_3$ is nearly insoluble (see Table 5).

At pH 7 and 10, respectively, a saturated $\text{Fe}(\text{OH})_3$ solution has the following free Fe^{3+} concentration:

$$c(\text{Fe}^{3+}) = \frac{K_L(\text{Fe}(\text{OH})_3)}{c^3(\text{OH}^-)} \quad (2)$$

$$\text{pH}=7: \quad \frac{2.67 \times 10^{-39} \text{ mol}^4 \text{ l}^{-4}}{10^{-21} \text{ mol}^3 \text{ l}^{-3}} = 2.67 \times 10^{-18} \text{ mol l}^{-1} \quad (3)$$

$$\text{pH}=10: \quad \frac{2.67 \times 10^{-39} \text{ mol}^4 \text{ l}^{-4}}{10^{-12} \text{ mol}^3 \text{ l}^{-3}} = 2.67 \times 10^{-27} \text{ mol l}^{-1} \quad (4)$$

Should the free Fe^{3+} concentration surpass this value due to a better solubility of Iron Blue, then Fe^{3+} would precipitate as hydroxide and would be increasingly removed from the pigment, thereby destroying it in the end. Since this does not happen at pH=7 at all, and pH=10 can be considered the point where it just starts to happen, the concentration of the Fe^{3+} ion in a saturated Iron Blue solution must lie well below 10^{-18} mol/liter, *i.e.*, in the area of 10^{-27} mol/liter. Thus, the solubility of Iron Blue must also have a value around 10^{-27} mol per liter (actually: $\frac{1}{4}$ of the free Fe^{3+} concentration, K_S less than $4.1 \cdot 10^{-187} \text{ mol}^7 \text{ l}^{-7}$, $\text{p}K_S$ larger

³⁸⁶ C. Wilson, *Wilson & Wilson's Comprehensive Inorganic Chemistry*, Vol. 1B, Elsevier, Amsterdam 1960, p. 162.

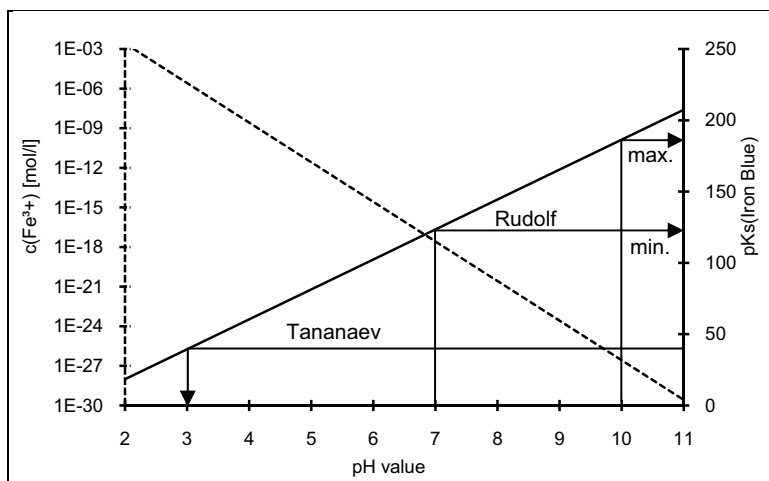

Graph 6: Free Fe^{3+} concentration as a function of pH value and the resulting minimal pK_S value of Iron Blue, depending on its stability at the corresponding pH value. pK_S value acc. to Tananaev *et al.* : 40.5; according to reflections made here: greater than 123, smaller than 186.

than 186.6) which, at a mol mass of $1,110 \text{ g mol}^{-1}$ ($(\text{Fe}_4[\text{Fe}(\text{CN})_6]_3 \cdot 14 \text{ H}_2\text{O})$) would correlate to 10^{-24} g .

With this, the complex iron pigment does indeed deserve to be called insoluble, as only one part of dissolved Iron Blue can statistically be found in 100,000,000,000,000,000,000,000,000 parts of water (10^{29}). The actual solubility would therefore be lower by a factor of 10^{20} than determined by Tananaev *et al.*, which would come pretty close to values calculated for other so-called “insoluble” compounds, like mercury sulfide (HgS). However, one must consider that the chemistry of Fe^{3+} in aqueous solutions doesn’t justify the terms “dissolved” or “precipitated,” since a multitude of complexes do exist in the broad pH-spectrum, partly as polymer hydroxo-aquo-complexes (compare chapter 6.5.3.).

Graph 6 shows the correlation between the pH value of the free Fe^{3+} -concentration in a hypothetical saturated solution of Iron Blue and the respectively resulting minimal pK_S values possible for Iron Blue, which it must possess, should stability prevail at the given pH-reading. From Tananaev’s pK_S value results that the pigment would remain stable only up to pH 3. Accordingly, it would dissociate itself by its *eigen* pH value of 4 (see chapter 6.6.1., note 376), which is formed in its own dispersion. Thus the magnitude of error in the results of Tananaev *et al.* and Krleza *et al.* is apparent.

These reflections show that iron, bound as hydroxides or oxides in solid materials, tends to dissolve in a neutral medium more readily than Iron Blue, since its equilibrium concentration must be higher than that of Iron Blue.

6.6.3. Excursus: Competing Ligands

As shown, OH^- ions may, due to the low solubility of $\text{Fe}(\text{OH})_3$, noticeably precipitate the Fe^{3+} of Iron Blue in pH media above 9 to 10. The residual hexacyanoferrate(II), on the other hand, would only decompose in strongly alkaline media, because $\text{Fe}(\text{OH})_2$ is simply more soluble (compare Table 5).³⁸⁷

Tartrate³⁸⁸ has, in contrast to oxalate, hardly any effects so that Fe^{3+} can be quantitatively removed from sour wine with $[\text{Fe}(\text{CN})_6]^{4-}$, a usual procedure to remove iron ions from wine.³⁸⁹ Concentrated alkali carbonate solutions will precipitate the Fe^{2+} of Iron Blue as FeCO_3 , so that they destroy the entire pigment by precipitating Fe^{3+} as $\text{Fe}(\text{OH})_3$ (due to alkalinity) and the hexacyanoferrate(II) salt $[\text{Fe}(\text{CN})_6]^{4-}$.³⁹⁰ Calcium carbonate solutions, however, would not be sufficient due to their marginal saturation solubility. Besides that, Kohn examined the supportive effect of most of the organic ligands to disperse Iron Blue.³⁹¹

Thus, apart from OH^- (alkaline medium), there are no other ligands to be considered competing in the formation or dissolution of Iron Blue in the cases here under consideration.

6.6.4. Effects of Light

6.6.4.1. Overview

Iron Blue itself is generally considered a light-resistant pigment, which is only slowly decomposed by the effects of UV radiation.³⁹²

³⁸⁷ In absence of free cyanide ions, the pH stability limit of hexacyanoferrate(II) (total dissociation) is at 11.8, but already very small amounts of free cyanide ($10^{-10} \text{ mol l}^{-1}$) push the limit up to pH=13.

³⁸⁸ Tartrate, corresponding base of tartaric acid. The mixed potassium-sodium-salt is the famous tartrate (potassium bitartrate), which crystallizes on the cork of wine bottles (Seignette salt).

³⁸⁹ C. Lapp, C. Wehrer, P. Laugel, *Analisis*, 13 (4) (1985), pp. 185-190.

³⁹⁰ G.-O. Müller, *op. cit.* (note 376).

³⁹¹ M. Kohn, *Anal. Chim. Acta* 3 (1949), pp. 558ff.; *ibid.*, 5 (1951), pp. 525-528; *ibid.*, 11 (1954), pp. 18-27.

³⁹² See also Winnacker-Küchler, *Chemische Technologie*, volume 2, Carl Hanser Verlag, Munich 1982, p. 197; H. Ferch, H. Schäfer, *op. cit.* (note 349); Wilhelm Foerst (ed.), *Ullmanns Encyklopädie der technischen Chemie*, volume 13, Urban und Schwarzenberg, Munich ³1962,

There are even patents utilizing Iron Blue as a UV-absorbing pigment, which is only meaningful with sufficient resistance to UV radiation.³⁹³ Since the walls of interest to us here are protected from UV radiation and because UV radiation can only exert a superficial effect on the walls, while the Iron Blue would form and remain within the walls, a possible process of decomposition by UV radiation can have no influence upon our investigation.

6.6.4.2. Excursus

Certain wavelengths of ultraviolet radiation may set free CN^- from hexacyanoferrate(II) and -(III), the preliminary stages of Iron Blue. As far as hexacyanoferrate(III) is concerned, this leads to the formation of Iron Blue.³⁵³ As far as hexacyanoferrate(II) is concerned, quantum efficiencies³⁹⁴ of 0.1 to 0.4 are reported for wavelengths of 365 nm.³⁹⁵

It has been discussed whether complex cyanides can be removed from industrial waste waters by ultraviolet radiation. The unbound cyanide will be oxidized and destroyed by hydroxyl radicals originating from the parallelly occurring photolysis of water.³⁹⁶ However, results are not unequivocal.³⁹⁷

As for Iron Blue, one knows of the bleaching effect under strong, perpetual sun radiation and the ensuing re-darkening during the night.³⁹⁸ Here also, the liberation of CN^- is responsible, which reduces parts of the Fe^{3+} ions to Fe^{2+} ions. The latter process, however, will reverse during the night under the influence of oxygen and moisture. The Iron Blue concentration will eventually be reduced by the loss of the released cyanide, either by evaporation of hydrogen cyanide, by washing out as CN^- , or by oxidation through Fe^{3+} /atmospheric oxygen or from hydrox-

p. 794; *ibid.*, volume 18, Verlag Chemie, Weinheim 1979, pp. 623ff.; H. Watanabe, *J. Jap. Soc. Col. Mat.*, 34 (1961), pp. 5-8; L. Müller-Focken, *Farbe und Lack*, 84 (1987), pp. 489-492.

³⁹³ H. Tada, M. Kunio, H. Kawahara, *Jpn. Kokai Tokkyo Koho*, 1990, 3 p. Source only available as abstract.

³⁹⁴ *Quantum efficiency* is that part of the absorbed light quants which leads to photo reactions under scrutiny, here from 10 to 40%.

³⁹⁵ L. Moggi, *et al.*, *op. cit.* (note 353); V. Carassiti, V. Balzani, *Ann. Chim.* 50 (1960), pp. 782-789.

³⁹⁶ *Photolysis* of water leads to the splitting of water into uncharged parts with unpaired electrons (formation of radicals through homolytic splitting (homolysis); see also dissociation, note 355):

$$2 \text{H}_2\text{O} + h\nu \rightarrow \text{H}_3\text{O}^+ + \text{OH}^- \quad (h\nu = \text{photo quant})$$
hydroxyl radical

³⁹⁷ M.D. Gurol, J.H. Woodman, *Hazard. Ind. Waste* 21 (1989), pp. 282-290; S.A. Zaidi, J. Carey, in: *Proceedings of the Conference on Cyanide and the Environment*, Colorado State University, 1984, pp. 363-377.

³⁹⁸ Deutsche Chemische Gesellschaft (ed.), *Gmelins Handbuch*, *op. cit.* (note 351); *Ullmanns Encyklopädie*, *op. cit.* (note 392); L. Müller-Focken, *op. cit.* (note 392).

yl radicals from the natural photolysis of water. The latter process is minute and can therefore be neglected. At any rate, most of the cyanide released by photolysis will again be complex bound to iron.

6.6.5. Long-Term Test

The best long-term test available to us consists of disinfestation buildings BW 5a and 5b in Birkenau, which have defied the wind and weather of the strongly corrosive climate in the industrial region of Upper Silesia for over 50 years, and which are still colored blue, both inside and out, exhibiting a high cyanide content. The same holds for the disinfestation buildings in Majdanek and Stutthof.^{332,334} These findings are also supported by two other long-term tests.

The color durability of Iron Blue, in addition to other pigments, was tested during an environmental resistance test lasting 21 years in the industrial district of Slough, west of London.³⁹⁹ In so doing, pieces of aluminium sheet metal were alternately dipped in an iron(II)-cyanide and then in an iron(III)-salt solution,⁴⁰⁰ by which the resulting pigment was adsorbed on the aluminium sheet metal. The test sheets were then exposed to the environment on the roof of a building in a vertical 45° angle facing southwest.

During the 21 years lasting test, in which eight Iron Blue samples were tested among other pigments, the Iron Blue, in particular, followed by iron ochre (Fe₂O₃, rust), exhibited only minimal alterations after this period of time. One sample of Iron Blue and iron ochre was removed only after 10 to 11 years in each case.⁴⁰¹ All other samples still exhibited an intense blue color. Half of the seven remaining Iron Blue samples received the value 4 out of a maximum of 5 points for the best retention of quality, on the gray scale used there in the determination of color changes. Only minor alterations were detected.

The exhibits were therefore exposed to the environmental conditions of a strongly industrialized area, with full effects of precipitation, direct sunshine, and wind erosion for more than 21 years. Under intense summer sunshine and in the absence of wind, the temperature of the dark-blue colored aluminium metal sheets rose steeply (Iron Blue is only

³⁹⁹ J.M. Kape, E.C. Mills, *Tranp. Inst. Met. Finish.*, 35 (1958), pp. 353-384; *ibid.*, 59 (1981), pp. 35-39.

⁴⁰⁰ K₃[Fe(CN)₆] or Fe(NO₃)₃.

⁴⁰¹ The literature does not, however, mention this Iron Blue sample as "Prussian Blue," like the others, since it was, at that time, considered to be of another type, i.e., "Turnbull's Blue" or "ferrous ferricyanide."

stable up to approximately 140°C⁴⁰²). Snow, frost, hail, storms, and the finest, driving acid drizzle had obviously just as little an effect on the pigment as the UV radiation of direct sunlight. What is remarkable is that in determining the degree of destruction of the pigment no unexposed samples were used since these had been lost over the 21-year period; rather, places on the surface of the exhibits which had been relatively well protected from direct environmental influences by the frames and by rubber rings on the screw joints were used as control samples. These exhibited almost no alterations.

In comparison to the environmental conditions which are of interest here, this long-term test involved considerably more severe conditions, since in this case, the externally formed Iron Blue was only superficially adsorbed upon the aluminium sheets. The pigment nevertheless resisted extremely well.

Another event proves the extraordinary long-term stability of Iron Blue. For many decades at the end of the 19th and the early decades of the 20th century, Iron Blue was a by-product in the generation of city gas, because the hydrogen cyanide contained in coke gas had to be eliminated for security reasons by washing it with iron hydroxide prior to introduction into the city gas network. Iron Blue is the end product of this washing process. City gas works frequently disposed of this product by distributing some of it over their factory terrain with the intent to kill weeds – in vain, though, since Iron Blue has no effect as an herbicide. Today, the grounds of former German city gas works still contain high quantities of Iron Blue, many decades after the works were put out of operation. It was neither decomposed, nor dissolved or washed away by rain water, since it is insoluble. In particular, terrain with a high Iron Blue content is not considered polluted, since it is physiologically unobjectionable due to its stability.⁴⁰³

In summary, it may be stated that Iron Blue having formed in the interior of a wall as a component of the wall itself, possesses a longevity comparable to the iron oxide from which it has formed. This means simply that Iron Blue possesses a degree of stability which is comparable to that of the masonry itself: the Iron Blue will remain contained in the wall for as long as the wall itself remains in existence.⁴⁰⁴

⁴⁰² Compare H. Ferch, H. Schäfer, *op. cit.* (note 349); S. Barbezat, *J. Réch. Cent. Nat. Réch. Sci.* 4 (1952), pp. 184ff.; E. Gratzfeld, *Färg och Lack*, 3 (1957), pp. 85-108; E. Herrmann, *Farbe und Lack*, 64 (1958), pp. 130-135.

⁴⁰³ D. Maier, K. Czurda, G. Gudehus, *Das Gas- und Wasserfach*, in: *Gas · Erdgas*, 130 (1989), pp. 474-484.

⁴⁰⁴ An interesting study has been conducted in this connection about the reduction of soluble components in concrete standing in water, providing support to the statements made here: not

Once perceptible quantities of cyanide have accumulated within a wall, therefore, and once conditions permit the conversion of the cyanide into Iron Blue, no perceptible reduction in the Iron Blue content can be anticipated, even after fifty years or more.

A typical example of the manner in which the media deal with these facts is a press report issued by the German Press Agency (*Deutsche Presseagentur*, DPA) on March 29, 1994, and which was then published in many German newspapers and even broadcast on radio. The report flatly claimed that, according to unnamed experts:⁴⁰⁵

“Cyanide compounds decompose very quickly. In the ground, this occurs even after six to eight weeks; in masonry, these compounds could only be preserved under ‘absolute conditions of conservation including complete exclusion of air and bacteria.’”

Inquiries with the DPA press office in Stuttgart, which had published the report, revealed that the writer responsible for the report, Albert Meinecke, had simply invented this expert opinion.⁴⁰⁶ This obvious lie continues to be further disseminated, even by German government agencies such as, for example, the Bavarian Ministry of the Interior.⁴⁰⁷

6.7. Influence of Various Building Materials

6.7.1. Brick

6.7.1.1. Overview

Bricks are well-known to acquire their hardness and stability during their baking process. This causes an intensive binding of the components in bricks (sintering). One result of this is that the reactivity of the iron oxide occurring in bricks (2 to 4%) is strongly reduced, so that a

even the concentration of alkali ions, which are the most soluble components of concrete, was massively reduced: H.A. El-Sayed, *Cement and Concrete Research*, 11 (1981), pp. 351-362.

⁴⁰⁵ Printed by German daily newspapers, for instance: *Süddeutsche Zeitung*, *Stuttgarter Zeitung*, *Südwestpresse-Verbund* (March 29, 1994), *taz*, *Frankfurter Rundschau* (March 30, 1994).

⁴⁰⁶ G. Rudolf, “Über die frei erfundene Expertenmeinung der ‘DPA,’” *Deutschland in Geschichte und Gegenwart* 42(2) (1994), pp. 25f.; see also G. Rudolf, C. Mattogno, *op. cit.* (note 58), pp. 113-126; Engl. see Part II, chapter 6, of this book.

⁴⁰⁷ See the Bavarian State Ministry for the Interior, *Verfassungsschutzbericht 1997*, Munich 1998, p. 64. A corresponding reference to the factual incorrectness of the remarks made in this regard by the *Arbeitskreis Zeitgeschichte und Politik* (in a letter by president Hans-Jürgen Witzsch, dated Oct. 8, 1998, Fürth) was countered by the Ministry as follows: “Your efforts to deny and/or relativize the crimes of the National Socialists have been known to the security authorities for years. [...] We see no occasion for a discussion of gas chambers.” The letter, from Dr. Weber of the Bavarian State Ministry of the Interior dated Oct. 13, 1998, ref. IF1-1335.31-1, probably established a new world record for stupidity.

perceptible inclination to form iron cyanide is hardly to be anticipated. The immediate surface of bricks slightly attacked by atmospheric influences (weathering) nevertheless constitutes an exception to this rule, so that the superficially adherent iron oxide is available for conversion into Iron Blue.

6.7.1.2. Excursus

The chemical composition of bricks varies massively due to the different sorts of marl and loam used as initial material. The content of clay (included in this are 20 to 60% kaolinite, consisting roughly of 47% SiO₂, 40% Al₂O₃, 13% H₂O) may lie between 20 and 70%, the rest being carbonate, finest sand and iron oxides.⁴⁰⁸ According to my own analyses, the latter content may vary between 2 and 4%.

The porosity values of bricks lie between 20 and 30 vol.%,⁴⁰⁹ according to other sources up to 50%.⁴¹⁰ According to my own mercury penetration tests, the pore size of bricks lies heavily concentrated around 1 µm.⁴¹¹

Due to the decreased specific surface (0.5 to 1 m² per g, BET,⁴¹² own tests), the reactivity of the iron oxide is strongly reduced. However, partly dissolved iron at brick surfaces immediately exposed to weathering can be set free for reactions in bigger amounts.

The normal free, *i.e.*, not chemically bound, water content of bricks in dry rooms (20°C) is in the area of one volume percent, but it can rise up to 4% at a relative humidity of over 90%.⁴¹³

6.7.2. Cement Mortar and Concrete

6.7.2.1. Overview

The rust content (Fe₂O₃) of Portland cement, of particular interest to us here, the cement most frequently used for concrete and cement mor-

⁴⁰⁸ O. Hähnle, *Baustoff-Lexikon*, Deutsche Verlagsanstalt, Stuttgart 1961, p. 384.

⁴⁰⁹ Landolt-Börnstein, *Zahlen und Funktionen aus Physik, Chemie, Astronomie, Technik*, volume IV *Technik*, part 4b *Wärmetechnik*, Springer, Berlin ⁶1972, pp. 433-452.

⁴¹⁰ S. Röbert (ed.), *Systematische Baustofflehre*, volume 1, VEB Verlag für Bauwesen, Berlin ⁴1983, p. 120.

⁴¹¹ These mercury penetration tests were performed at the research institute of the VARTA Batterie AG in Kelkheim, Germany, in late 1991.

⁴¹² Method to determine the specific surface with nitrogen adsorption following Brunauer, Emmet, Teller.

⁴¹³ K. Wesche, *Baustoffe für tragende Bauteile*, volume 1, Bauverlag, Wiesbaden 1977, p. 37.

tars, is usually between 1 and 5%.⁴¹⁴ The sand added to the mortar can also exhibit a high iron content (up to 4%). As mentioned in chapter 6.5.3., a large surface area at the solid-liquid phase limit (iron oxide-cyanide solution) is favorable to the formation of Iron Blue. This is extraordinarily large in cement and concrete mortars (microscopic interior surfaces of approximately 200 m² per gram).⁴¹⁵

Fresh concrete and cement mortars – which are identical from a chemical point of view – are relatively strongly alkaline (pH approximately 12.5). It later falls, however, due to the binding of carbon dioxide from the air. Depending on the special chemistry of the cement mortar, this process proceeds very slowly in the depth of the material. According to the composition of the cement mortar, this may last from a few months to many decades, until the pH value of such a mortar or concrete becomes neutral, even in the deepest layers.⁴¹⁴⁻⁴¹⁶ This chemical behavior explains the stability of reinforced concrete, which prevents the embedded steel from rusting further in the environment within the concrete, which remains alkaline for lengthy periods of time.⁴¹⁷

The water content of concrete and cement mortars depends on the temperature and relative humidity of the air and fluctuates between 1% and less at 20°C and 60% relative humidity up to 10% in air saturated with humidity.⁴¹³ In case of permanently high humidity, penetrating wetness from outside, a major part of the pore system can be filled with water.⁴¹⁸

Poorly insulated rooms built underground always have cool and humid walls due to their great exchange surface area with the ground. The high water content is due partly to the absorption of humidity from the ground and partly to the condensation of humidity from the air on the cool walls, when the temperature falls below the dew point. The water content of non-insulated cellar walls in unheated rooms therefore lies around 10%, *i.e.*, a factor of approximately 10 or more above that of dry walls of heated rooms above ground.

⁴¹⁴ W.H. Duda, *Cement-Data-Book*, Bauverlag, Wiesbaden 1976, pp. 4ff., as well as my own analysis.

⁴¹⁵ W. Czernin, *Zementchemie für Bauingenieure*, Bauverlag, Wiesbaden 1977, pp. 49f.

⁴¹⁶ N.V. Waubke, *Transportphänomene in Betonporen*, Dissertation, Braunschweig 1966.

⁴¹⁷ In the strongly alkaline environment, iron is passivated by a passive layer of Fe(OH)₃.

“Botched work” on building sites, *i.e.*, rusting reinforcement rods and cracking concrete after only a few years or decades, due to overly low pH value in the vicinity of the embedded reinforcement rods, is caused by a) an incorrect composition of the concrete (too little cement – it’s cheaper this way – and/or too much or too little water – incompetence), or b) by installing the reinforcement rods too close to the surface of the concrete, where the pH value drops noticeably after a few years or decades; see notes 414f.

⁴¹⁸ K. Wesche, *Baustoffe für tragende Bauteile*, volume 2, Bauverlag, Wiesbaden 1981, pp. 51f.

6.7.2.2. Excursus

The chemical composition of Portland cement, the most frequently used cement for concrete and water mortar, can be seen in Table 6.

Al ₂ O ₃ : 5 to 10 %	K ₂ O: 0.2 to 0.6 %
SiO ₂ : 20 %	Na ₂ O: 0.5 to 3 %
CaO : 60 %	Fe ₂ O ₃ : < 5 %

The specific surface of the cement powder is in the order of 3,000 cm² per g. Concrete and cement mortar get their stability by hydration of the cement compounds calcium oxide CaO (burnt lime), silicon dioxide SiO₂ (quartz), iron and aluminium oxide Fe₂O₃/Al₂O₃, to mixed, microfibrinous calcium aluminosilicate-hydrates with a chemically bound water content of some 25 mass %.⁴²⁰ It then has a specific surface of up to 200 m² per g when measured with water adsorption, which is an extremely high value. Other methods (e.g. BET-measuring with nitrogen) yield a value of only 1/3 of this or less.⁴¹⁵ The porosity of mortar and concrete heavily depends on the amount of water added during preparation and lies at a minimum of 27% according to the literature,⁴¹⁸ in which case the volume of the microcapillary pores between the silicate fibers is included as well, which cannot be determined with mercury penetration measurements.

Aside from the absolute porosity, the pore size distribution is decisive for the reactivity towards gases. If the main pore volume is formed by microscopic pores, then the gas diffusion into the material is more inhibited than if the main pore volume is formed by larger pores. Graph 7 shows the accumulated pore volume distribution of concrete and one wall mortar (exact composition unknown, since taken from an old wall, but according to its brittle consistency probably a lime mortar).

Having a similar total pore volume like the wall mortar (here only 14% due to the test method), the concrete's largest portion of pore volume lies between a pore radius of 0.01 and 0.1 μm, whereas the wall mortar's largest portion lies between 0.1 and 10 μm. Hence, if compared with the wall mortar, the gas diffusion into the concrete will be disadvantaged. In general, the average pore size of cement building materials changes to larger values when increasing the content of sand and lime.

⁴¹⁹ W.H. Duda, *op. cit.* (note 414).

⁴²⁰ Verein Deutscher Zementwerke, *Zement Taschenbuch 1972/73*, Bauverlag, Wiesbaden 1972, pp. 19ff.

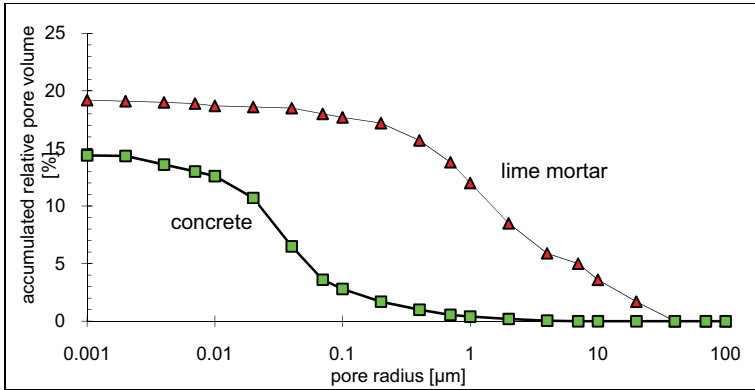

Graph 7: Accumulated pore volume distribution of concrete, according to "Forschungs- und Materialprüfungsanstalt, Abteilung 1: Baustoffe" (Research and Material Testing Agency, Department 1: Building Materials), Stuttgart, and of wall mortar, own analysis. In each case determined by Hg penetration.

Fresh concrete is relatively strongly alkaline, caused by the high content of calcium hydroxide, which, however, gets bound as calcium aluminosilicates rather quickly. However, depending on the type of cement, a certain amount of it is released as time goes by. The pH value of non-carbonated concrete is around 12.5. It later falls, however, due to the binding of carbon dioxide from the air.

The speed of carbonation into the depth of the concrete depends strongly on the consistency and porosity of the material and follows a square root relationship:⁴²¹

$$d = C \cdot \sqrt{t} \quad (5)$$

d = depth of carbonation

C = constant

t = time

In water tight concretes, it takes many years for the limit of carbonation to advance only a few centimeters due to the inhibition of diffusion in this highly compact material.

In the area of carbonation, the pH value decreases to roughly 7, the equilibrium value of saturated calcium carbonate solutions. But if the wall is wet, this results in a proton exchange and therefore no sharp pH border is formed. If a large portion of the air pores (size in the order of a tenth of a millimeter) is flooded with water poor in carbon dioxide, the carbonation advances more slowly, because compared to the gaseous phase, diffusion in aqueous phases is much slower, by some orders of

⁴²¹ W. Czernin, *op. cit.* (note 415); Verein Deutscher Zementwerke, *op. cit.* (note 420); N.V. Waubke, *op. cit.* (note 416).

magnitude. In case of waters rich in carbon dioxide, however, this can accelerate the carbonation.

6.7.3. Lime Mortar

The iron content of lime mortars is based, in particular, on the added sand (up to 4% Fe_2O_3). Lime mortar is manufactured using only burnt lime (CaO), sand and water, and acquires its solidity through the binding of slaked lime ($\text{Ca}(\text{OH})_2$) with atmospheric carbon dioxide to lime (CaCO_3). This procedure takes only days or weeks (depending on the thickness of the particular layers and the CO_2 content of the atmosphere), due to the cruder porous system, which facilitates the diffusion of gas. For fresh lime mortar, high water contents can be damaging, as the carbon dioxide necessary for the binding process can no longer penetrate into the wall.

The final pH value of this material lies within the neutral range. Since this medium no longer provides sufficient protection for steel reinforcement rods and offers only slight environmental resistance, it is usually used for the plastering of interior walls and for interior brick walls only, in the latter case often mixed with cement.⁴¹⁸ The specific surface of lime mortar lies considerably beneath that of cement mortar (up to one order of magnitude).⁴²² The water content is similar to cement mortar.

6.7.4. Effects upon the Formation of Iron Blue

The first step in the formation of Iron Blue in masonry is the diffusion of HCN into the masonry and through the gas-liquid interface from the air into the capillary water. The small capillary systems of cement mortars and concretes impede the diffusion of HCN more than the coarser capillaries of lime mortar. In case of an increased CO_2 content, the formation of a solid calcium carbonate layer at the air-water interface impedes the diffusion further. Since the thickness of this layer will increase proportionally with the pH value, alkaline cement mortars and concretes will impede the diffusion of HCN into their capillary water even more.

The second step is the accumulation of gaseous hydrogen cyanide in the capillary water. A cool (10°C) wall in a cellar with atmospheric humidity near the saturation point, due to its higher water content (by a

⁴²² The reason: no formation of very finely crystalline aluminosilicate with higher surface area.

factor of at least 10), has an increased ability (by a factor of 10) to absorb hydrogen cyanide, compared to warm walls in a heated room built above ground with lower atmospheric humidity (20°C, 50% rel.).

The third step in the formation of Iron Blue is the ionic split (dissociation) of the hydrogen cyanide, that is, its conversion into simple cyanide, and its accumulation.⁴²³ This procedure is favored by an alkaline environment, which, in lime mortars, lasts only for a few days or weeks, but which is present for months or years in cement mortar and concrete.

The next step is the formation of iron(III)-cyanide, a process that hardly occurs in a strongly alkaline environment and which occurs slowly in slightly alkaline environments. In the neutral range, this reaction is once again slowed down, because the cyanide also converts into non-reactive, volatile hydrogen cyanide by the humidity in the wall. The environment around the carbonation limit of concrete and mortar (which is slightly alkaline), can therefore be addressed as the area in which iron(III)-cyanide can form easily. In a strongly alkaline area of the masonry, it only arrives at this prior stage of Iron Blue formation through the slow detour of the reduction of slight traces of iron(III)-cyanide to iron(II)-cyanide. A large surface area, as found in cement mortars and concrete, is especially favorable to the solid-liquid interface reaction between solid rust and cyanide in a liquid solution. These generally have the advantage of retaining an alkaline medium for longer periods of time, so that the cyanide accumulated in the masonry is not lost and has enough time to react with rust. Once again, a high water content, which broadens the range of moderately alkaline pH values, is advantageous.⁴²⁴ The reduction of a part of the iron(III)-ions to iron(II)-ions finally, the next to last step in Iron Blue formation, requires a moderately alkaline pH value, but also occurs in the strongly alkaline range.

A distinction can be made between three areas of different reactivity in masonry:

1. Larger quantities of cyanide ions can accumulate in the non-carbonated portion, due to the alkaline medium, further favored by the increased absorption of hydrogen cyanide by the still-humid material. The cyanide is only bound as iron(III)-cyanide to a slight extent. This is converted quite rapidly into the more stable iron(II)-

⁴²³ In masonry, this largely corresponds to the neutralization of the hydrogen cyanide by calcium hydroxide $\text{Ca}(\text{OH})_2$ into calcium cyanide $\text{Ca}(\text{CN})_2$.

⁴²⁴ Very humid mortars and concretes, due to proton diffusion, exhibit no sharp carbonation, *i.e.*, pH limit.

Table 7: Absorption of hydrogen cyanide by various building materials under the effect of 2% HCN by volume over 24 hours.⁴²⁷

MATERIAL	HCN [mg m ⁻²]
Terracotta.....	55.2
Brick	73.0
Lime sandstone, naturally humid.....	22,740.0
Lime sandstone, briefly dried	4,360.0
Lime sandstone, dried approx. ½ year at 20°C	2,941.0
Concrete block, dried for 3 days.....	8,148.0
Lime mortar blocks, a few days old*.....	4,800.0
Cement mortar blocks, a few days old*	540.0
Cement mortar blocks, a month old*	140.0
Cement blocks, pure, a few days old*	1,550.0

* 2.5 to 3.3% HCN by volume.⁴²⁵ The vol. % data, according to the authors, represent theoretical nominal values, which, in practice, however, are only reached up to 50% or less, through adsorption onto walls and fumigation materials.

cyanide due to its strong oxidation behavior in the alkaline medium. An accumulation of iron(II)-cyanide will therefore take place over a longer time period.

- In the zone of carbonation, the tendency to accumulate cyanide is reduced, since the disassociation equilibrium lies increasingly on the side of hydrogen cyanide. The oxidation strength of iron(III)-cyanide is also diminished. On the other hand, the pigment itself now becomes stable, so that increased quantities of iron(II)-cyanide will be converted into Iron Blue, intimately mixed with the lime which is now also forming in this area, with the now somewhat more easily soluble iron(III)-ion at the carbonation limit.⁴²⁶
- In the pH-neutral, carbonated part of the masonry, the formation is considerably dependent on the available cyanide concentration, which is strongly reduced there. Already formed iron(II)-cyanide is gradually converted into Iron Blue in the presence of humidity.

Table 7 shows the adsorption values of hydrogen cyanide in various building materials.⁴²⁷ They confirm the assumption of considerably higher reactivity of cements compared to brick, as well as the greater tendency of fresh cement compared to older, and generally more humid building materials toward accumulating hydrogen cyanide.

⁴²⁵ F. Puntigam, *et al.*, *op. cit.* (note 126), pp. 35ff.

⁴²⁶ From the CO₂ in the air and the Ca(OH)₂ in the mortar.

⁴²⁷ L. Schwarz, W. Deckert, *Z. Hygiene und Infektionskrankheiten*, 107 (1927), pp. 798-813; *ibid.*, 109 (1929), pp. 201-212.

The hydrogen cyanide accumulation in the concrete block, the age of which is unfortunately not indicated, is astonishingly high, if compared with the cement mortar blocks. Because there is no considerable difference between the composition and hence the physical and chemical properties of cement mortar and concrete, it is not clear how the differing analytical results are to be interpreted. It must be kept in mind that the method used by the authors actually measures only the amount of hydrogen cyanide released by the samples after their exposure to HCN. Hence this method cannot establish any possible long-term physical or chemical binding of hydrogen cyanide in the samples. The authors moreover gave no details about the composition of their samples, other than giving them the names as listed. These data are therefore not unusable.

At least the tendency of humid masonry to absorb higher quantities of hydrogen cyanide is confirmed (compare lime sandstone: factor 8 at equal temperature and relative atmospheric humidity, but different prior history). W.A. Uglow showed in a detailed series of tests that concrete absorbs approximately four to six times as much hydrogen cyanide as lime mortar. He also found a tendency of humid building materials towards increased adsorption of hydrogen cyanide. He also noted a dark blue pigmentation running through the entire concrete sample and did not therefore exclude the possibility of a chemical reaction of the hydrogen cyanide with the material.⁴²⁸

The durability of very high concentrations of hydrogen cyanide over longer periods of time even in dry, chemically bound cement may be seen from Graph 8. Concentrations do not fall below ¼ of the initial values even after three days. With daily fumigation lasting several hours, this resulted, in this example, in average HCN concentration in the wall swinging around approximately 100 to 200 mg hydrogen cyanide per m² of masonry.

The measurement values in Graph 8 were approximated by a function consisting of two terms:

$$c(t) = 100 \cdot e^{-(t/0.3)} + 100 \cdot e^{-(t/4)} \quad (6)$$

$c(t)$ = HCN concentration at time t
 t = time in days

The first term in the above can be interpreted as desorption from the surface material with a τ ⁴²⁹ of 0.3 days. The second term describes a slower desorption of hydrogen cyanide with a τ of four days, perhaps

⁴²⁸ W.A. Uglow, *Z. Hygiene und Infektionskrankheiten*, 108 (1928), pp. 108-123.

⁴²⁹ τ is the time after which the value has fallen to the 1/e-multiple (0.368...) of the initial value.

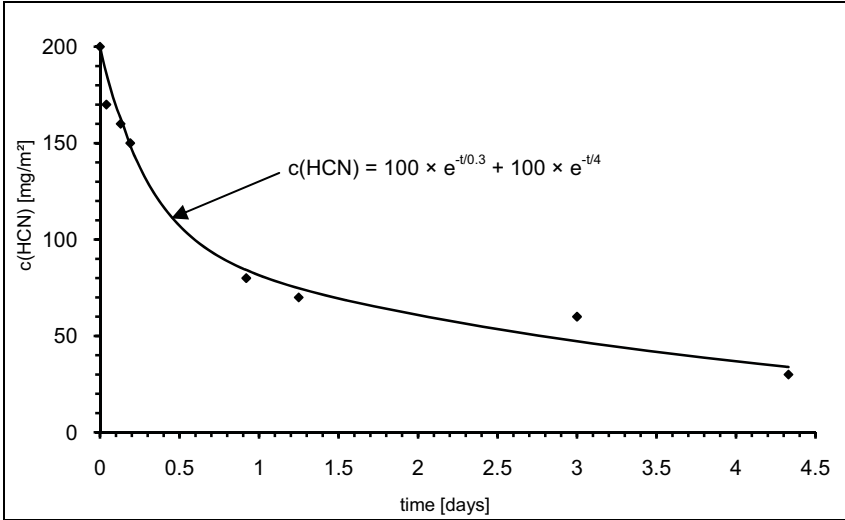

Graph 8: Drop in the hydrogen cyanide concentration in old, dry, cement blocks, after 24-hour fumigation with 2.5% HCN by volume⁴²⁷ (see footnote in Table 7, S. 175).

caused by the much slower diffusion through the capillary water of the samples. Larger errors relating to the drop in concentration described here will be made over longer periods of time, because the release of hydrogen cyanide is increasingly inhibited by physical and chemical effects (forming of stable compounds).

An analogous function is assumed by the absorption of hydrogen cyanide:

$$c(t) = 100 \cdot (2 - e^{-(t/0.3)} - e^{-(t/4)}) \quad (7)$$

This is only a correct description of the process when the concentration of hydrogen cyanide in air in the room remains constant. The function then reaches its maximum saturation after approximately 20 days. In order to allow for such an approximation, one must reduce the gassing time involved in such a way as to equal real conditions with variable concentrations. In case of a series of consecutive gassings and airings of masonry, a quasi-constant concentration will be reached after 20 cycles as well.

7. Zyklon B for the Killing of Human Beings

7.1. Toxicological Effect of HCN

The effect of hydrogen cyanide is based on the fact that it paralyzes the respiration of every individual cell in the body. Oxygen can no longer be transported from the blood through the cell walls into the cells.⁴³⁰ As the vital cell functions are thereby starved of oxygen, the animal or human being suffocates.

Insects and, in particular, insect eggs, are considerably less sensitive to hydrogen cyanide than warm-blooded animals. On the one hand, this is due to their greater resistance (slower metabolism). On the other hand, this is due to the fact that lethal concentrations of the gas must penetrate every crack and fissure, no matter how tiny. Every hem and seam of the garments to be fumigated must be filled with the poison in order to kill, for example, every concealed louse. Warm-blooded animals, by contrast, are rapidly exposed to high concentrations of the gas, not only because of their size, but above all due to their continuous breathing through lungs.⁴³¹

Lethal doses of cyanide can be ingested orally, inhaled, or absorbed through the skin. Oral poisoning (for example, with potassium cyanide KCN) is very painful due to muscular convulsions caused by cell suffocation. Even though victims of poisoning by inhalation of high concentrations of hydrogen cyanide become more rapidly unconscious than with oral ingestion, painful convulsions caused by muscular suffocation appear in these cases as well. For this reason, execution by use of hydrogen cyanide gas, as performed in some U.S. states, has recently been a topic of much controversy; see chapter 1. A dose of 1 mg cyanide per kg body weight is generally considered lethal. Non-lethal doses of cyanide are quickly decomposed and excreted by the body.⁴³²

⁴³⁰ Reversible attachment of the cyanide onto the Fe^{3+} of the cell-specific enzyme of respiration, cytochrome oxidase, thereby interrupting the supply of oxygen to the cells, rendering impossible the processes of respiration, which are essential for the life of the cell.

⁴³¹ Insects can “hold their breaths” for a long time: “The respiratory organs of terrestrial insects consist of tracheal tubes with external spiracular valves that control gas exchange. Despite their relatively high metabolic rate, many insects have highly discontinuous patterns of gas exchange, including long periods when the spiracles are fully closed.” Stefan K. Hetz, Timothy J. Bradley, “Insects breathe discontinuously to avoid oxygen toxicity,” *Nature*, no. 433 (3 February 2005), pp. 516-519, here p. 516; www.nature.com/nature/journal/v433/n7025/abs/nature03106.html

⁴³² Binding onto sulfur (to form rhodanide).

The bright red coloration of the blood and bruised spots, caused by over-saturation of the blood with oxygen, since the blood can no longer give off its oxygen to the cells, are generally considered, among other things, symptomatic of hydrogen cyanide poisoning in fatal cases.^{18,433-435} Testimonies describing a blue or green coloration of the victims are therefore false.⁴³⁶

Absorption through the skin is especially likely when the skin has become moist, for example, as a result of sweating at work. It is generally advised to avoid sweating during the handling of hydrogen cyanide. In this regard, concentrations from 6,000 ppm⁴³⁷ (0.6 % by volume) constitute a health hazard, while 10,000 ppm (1% by volume) can cause death in just a few minutes.⁴³⁸

Table 8 shows the effects of various concentrations of hydrogen cyanide, found in the literature.⁴³⁹

Table 8: Effect of various concentrations of hydrogen cyanide in air upon human beings

2 to 5 ppm:	Perceptible odor ⁴⁴⁰
10 ppm:	Maximum permissible work site concentration, acc. to German law
20 to 40 ppm:	Slight symptoms after a few hours
45 to 54 ppm:	Tolerable for ½ to 1 hour without significant or delayed effect
100 to 200 ppm:	Lethal within ½ to 1 hour
300 ppm:	Rapidly fatal

F. Flury and F. Zernik indicate that 200 ppm can be fatal within five to ten minutes, while 270 ppm are immediately fatal.⁴³⁸ These are not, of course, the results of experiments on human beings, but rather extra-

⁴³³ Wolfgang Wirth, Christian Gloxhuber, *Toxikologie*, Georg Thieme Verlag, Stuttgart 1985, pp. 159f.

⁴³⁴ Wolfgang Forth, Dieter Henschler, Werner Rummel, *Allgemeine und spezielle Pharmakologie und Toxikologie*, Wissenschaftsverlag, Mannheim 1987, pp. 751f.

⁴³⁵ Hans-Herbert Wellhöner, *Allgemeine und systematische Pharmakologie und Toxikologie*, Springer Verlag, Berlin 1988, pp. 445f.

⁴³⁶ This is why Michal Kula's statement about the color of gassing victims – "I saw then that they were greenish," proves that he never saw what he claims he did, see p. 120.

⁴³⁷ ppm stands for "parts per million"; here, 1 ppm HCN corresponds to 1 ml HCN per m³ (1,000,000 ml) of air.

⁴³⁸ F. Flury, F. Zernik, *Schädliche Gase, Dämpfe, Nebel, Rauch- und Staubarten*, Berlin 1931, p. 405; see also M. Daunderer, *Klinische Toxikologie*, 30th suppl. delivery 10/87, ecomed, Landsberg 1987, pp. 4ff.; considering the age of the first source as well as the vast amount of literature quoted in chapter 5.2.2., Pressac's claim on page 147 of his first book (note 72) that the lethal dose was not known is completely false. It was also already a known fact in those days that HCN could be absorbed via the skin.

⁴³⁹ DuPont, *Hydrogen Cyanide*, Wilmington, Delaware 7/83, pp. 5f.

⁴⁴⁰ HCN has a very faint smell which is not perceptible by everyone. The literature frequently mentions a smell like "bitter almonds," even though this is misleading, as bitter almonds have a very strong nutty scent, which HCN does not have. The HCN content of bitter almonds is too low to be perceptible next to the strong scent of nuts.

polations, in which lower risk thresholds have been determined on the grounds of safety. This will be demonstrated in the following. To kill an average person with a body weight of 100 kg, the victim must therefore ingest approximately 100 mg hydrogen cyanide (1 mg per kilo body weight). The respiration of a human being at rest amounts to approximately 15 liters of air per minute.⁴⁴¹ With a hydrogen cyanide content of 0.02% (approximately 0.24 mg per liter) the victim must inhale approximately 416 liters of air before ingesting the fatal quantity of hydrogen cyanide. At 15 liters per minute, this will take about half an hour. A very strong person can survive even this period of time. By contrast, a sensitive person weighing 50 kg breathing at an accelerated rate as a result of physical effort or excitement will inhale 40 liters per minute, ingesting a fatal dose of 208 liters of air in five minutes. It is obvious from these calculations that the data in safety instructions are always intended to protect smaller, weaker people from accidents under the most unfavorable circumstances. The data given in the literature as “immediately” or “rapidly fatal” doses are furthermore so indefinite as to be unable to satisfy our purposes. In addition, they only refer to the time when a victim has ingested a fatal dose, but not when death occurs, which can be considerably later.

The threshold values will be different if we require even the strongest individual, out of all conceivable individual victims, to die in just a few minutes.⁴⁴² The concentrations necessary for this purpose will, by its very nature of the thing, be several times higher than the values indicated above. They could only be determined by a series of experiments, which is naturally impossible with human beings. The only data available to us are those gathered during executions with hydrogen cyanide carried out exclusively in the United States. Leuchter speaks of concentrations of hydrogen cyanide used in executions in the USA in the order of magnitude of 3,200 ppm. In these cases, death occurs after 4 to 10 minutes, depending on the physical constitution of the victim.⁴⁴³ Press reports from the USA indicate that executions can easily last 10 to 17 minutes (see chapter 1.1.). It must be stressed, though, that this time applies to the point when the executee is actually declared dead, which requires that the heart must have stopped beating. Unconsciousness and immobility will have set in before that. Lethal amounts ingested already before death occurs would lead to the victim’s demise, even if the expo-

⁴⁴¹ Robert F. Schmidt, *Biommaschine Mensch*, Piper, Munich 1979, p. 124.

⁴⁴² Among toxicologists known as the lethal dose for 100% of all victims, LD₁₀₀.

⁴⁴³ F. A. Leuchter, Boston, FAX to H. Herrmann dated April, 20, 1992, as well as private communication from Mr. Leuchter.

sure to HCN were to end before cardiac arrest – unless immediate and drastic medical help is provided. This slow death can drag on for up to an hour.^{444,445}

In relation to the quantities used, the U.S. execution gas chamber in Raleigh (North Carolina), for example, is said to use 454 g KCN in half concentrated sulfuric acid, leading to instant formation of hydrogen cyanide vapor, which is even visible for a short period to the witnesses in the witness room and which reaches the victim in seconds.² As a matter of pure calculation, this generates approximately 180 g of hydrogen cyanide, corresponding to 150 liters of gas. However, since a considerable part of it remains dissolved in the half concentrated sulfuric acid (approximately 50%, see chapter 8.3.3.4.), we assume in the following that approximately 90 g or 75 liters of hydrogen cyanide are released as gas. In North Carolina, this gas arises immediately beneath the victim, so that the victim must be exposed, immediately after the beginning of the execution process, to a concentration which probably exceeds 10% by volume for a short period, but then falls steadily as a result of diffusion of the hydrogen cyanide throughout the chamber.⁴⁴⁶

At a normal respiration volume of approximately 15 to 20 liters per minute, and assuming an average concentration during the execution of only 0.75% by volume, approximately 1.35 to 1.8 grams of HCN will be ingested in 10 minutes (150-200 liters of inhaled air), which corresponds to ten to twenty times the fatal dose. In the following calculations, we will assume a ten-fold overdose only, in order to render unconscious and motionless all the people in the chamber with certainty within ten minutes (see the case of Lawson, p. 11), leading to their subsequent death within another ten minutes at the latest.

7.2. Evaporation Characteristics of Zyklon B

Zyklon B does not release its poison gas instantaneously, but rather over an extended period of time. Since this period of time can be decisive for the evaluation both of eyewitness accounts as well as of chemical analyses, it will be investigated more thoroughly in this chapter.

R. Irmscher of Degesch reported in a paper written in 1942 that, at that time, the use of cardboard discs and gypsum (Ercco) were the most

⁴⁴⁴ M. Daunderer, *op. cit.* (note 438), p. 15.

⁴⁴⁵ Satu M. Somani (ed.), *Chemical Warfare Agents*, Academic Press, San Diego 1992, p. 213.

⁴⁴⁶ Assuming a volume of 10 m³ in the chamber, 75 Liter HCN corresponds to 0.75% by volume, *i.e.*, somewhat more than double the end values taken by Leuchter.

commonly used carrier material.⁴⁴⁷ The gypsum version was used – even according to eyewitness testimony – in the concentration camps.

The evaporation characteristics of this product at various temperatures, low relative humidity of the air, and a fine distribution of the carrier material are reproduced in Graph 9 as given by Irmscher. The evaporation is “serious-

ly delayed” at high atmospheric humidity, because the evaporating hydrogen cyanide withdraws considerable quantities of energy from the liquid HCN, the carrier material and the ambient air. As a consequence, the temperature of the product and the ambient air drops. If the temperature of the air reaches the dew point, atmospheric humidity condenses out onto the carrier material, which binds the hydrogen cyanide and slows down the evaporation process. Unfortunately the graph does not contain data for higher temperatures, but when considering the difference between the graphs for 0°C and 15°C, we can make a rough extrapolation of a graph for 30°C.

For later references, we want to keep in mind that, at 15°C and in the presence of lower atmospheric humidity, approximately 10% of the hydrogen cyanide used at Auschwitz has left the carrier material during the first five minutes, and approximately 50% after half an hour. At a temperature of 30°C, it can be expected that 15% would have been released within the first five minutes, and up to 60% after half an hour. In

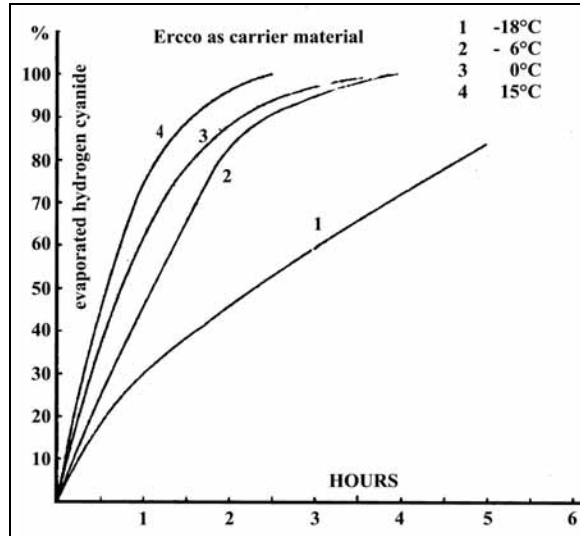

Graph 9: Evaporation rate of hydrogen cyanide from the Ercco carrier material (gypsum with some starch) at various temperatures and fine distribution, according to R. Irmscher/Degesch 1942.⁴⁴⁷

⁴⁴⁷ R. Irmscher, “Nochmals: ‘Die Einsatzfähigkeit der Blausäure bei tiefen Temperaturen,’” *Zeitschrift für hygienische Zoologie und Schädlingsbekämpfung*, 1942, pp. 35f.; on the history of the development of Zyklon B, see Wolfgang Lambrecht, “Zyklon B – eine Ergänzung,” *VffG* 1(1) (1997), pp. 2-5.

areas with a relative humidity of approximately 100%, the evaporation times would have been “seriously delayed,” however.

The question of how Zyklon B would have behaved if dumped in a heap on the floor – hence *not* finely spread out – in a room filled with human beings, is somewhat more difficult. The radiant heat of the bodies would have accelerated the evaporation by increasing the temperature in the vicinity of the floor. Further acceleration of evaporation may have occurred due to a possible reduction in size of the carrier granules as a result of being trampled upon or crushed by falling human bodies, as well as direct bodily contact.

On the other hand, the relative atmospheric humidity in the cellars of Crematoria II and III, which certainly would have approached 100% when packed full of people, would have “seriously delayed” evaporation,⁴⁴⁸ as well as the possible fluid secretions on the floor caused by panicking victims, which could very well have occurred as soon as the door was closed, that is, prior to release of the Zyklon B. If considering witness claims that the chamber floor was rinsed out with water hoses after each gassing, then the floor would indeed have been wet already before the entry of any victim. Under such conditions, a serious delay in the discharge of the hydrogen cyanide from the seriously wet carrier material would have to be anticipated.

If assuming – against the actual situation as proven by material evidence – that Zyklon B introduction devices were installed in some of the Auschwitz “gas chambers” as attested to by Michal Kula and others,⁴⁴⁹ such a device would have had the following effects:

a) The Zyklon B granules would not have been spread out, but rather would have been kept together by the inner wire mesh (or, even worse, within a tin or a can, as claimed by Henryk Tauber and Josef Erber²⁸⁵), reducing the evaporation rate considerably.

b) The three layers of wire mesh claimed by Kula would have drastically reduced any air convection within them, reducing both evaporation rate as well as the speed with which the gas spreads out into the chamber

c) Due to high humidity in the air and the lack of air convection, moisture would have condensed intensively on the Zyklon B carrier, reducing the evaporation rate of HCN “seriously.”

⁴⁴⁸ Unheated cellar rooms by their very nature, have very high relative atmospheric humidity. As a result of the large numbers of human beings crammed into the cellar, the atmospheric humidity would certainly approach 100%, resulting in the condensation of water on cold objects.

⁴⁴⁹ See chapter 5.4.1.2.8., p. 119, for this.

The present study regarding homicidal mass gassings will be based on the assumption that the Zyklon B would at best have behave in the manner described by Irmischer at 15°C (see above), which is assumed to be similar to a temperature inside the chamber of 30°C, a relative humidity near 100%, and a carrier wetted by a wet floor and/or not finely distributed.

7.3. The Gassing of Human Beings

7.3.1. Eyewitness Testimonies

7.3.1.1. Boundary Conditions

This chapter will examine a few related eyewitness testimonies for a determination of the chemical, physical and technical boundary conditions of the alleged homicidal gassings. A complete and detailed analysis of the many eyewitness testimonies in the individual trials and in the literature would be too voluminous to include here.⁴⁵⁰ The following survey is therefore not complete.

In two separate studies I have analyzed the coercive and manipulating conditions under which many eyewitness statements were made, to which I refer the interested reader.⁴⁵¹ It suffices to say that those conditions, many of which prevail to this very day in western societies, undermine the trustworthiness of most witnesses and the credibility of their claims. These statements should therefore never be accepted at face value, but subjected to careful, skeptical scrutiny.

7.3.1.2. Eyewitness Fantasies

The following is a closer examination of three of the more frequently quoted eyewitnesses: Rudolf Höß, former camp commandant at Auschwitz, Richard Böck, a camp SS man of subordinate rank, as well as Henryk Tauber, former inmate and member of the “*Sonderkommando*” in Crematorium II in Birkenau.⁴⁵²

The Höß statements may be consulted in the Broszat edition and read as follows:³¹¹

⁴⁵⁰ See, in this regard, the excellent analysis of J. Graf, *Auschwitz. Tätergeständnisse und Augenzeugen*, *op. cit.* (note 47) as well as C. Mattogno’s various special studies (note 100).

⁴⁵¹ “The Value of Testimony and Confessions Concerning the Holocaust,” G. Rudolf (ed.), *op. cit.* (note 24), pp. 85-131; G. Rudolf, *Lectures on the Holocaust*, Theses & Dissertations Press, Chicago 2005, pp. 345-486.

⁴⁵² For a more thorough analysis of Höß’s and Tauber’s statements with further references cf. C. Mattogno, *op. cit.* (note 76), pp. 375-439.

“Maintaining the fire at the ditches, pouring the collected fat [over the burning bodies ...] They ate and smoked while dragging corpses [...]” (p. 126)

“The bodies were doused first with oil residues, and later with methanol [...] He [Paul Blobel⁴⁵³] also attempted to destroy the bodies with explosives, [...]” (p. 157ff.)

“Half an hour after the introduction of the gas, the door was opened and the ventilation installation was turned on. Removal of the bodies began immediately [...]” (p. 166.)

and elsewhere:⁴⁵⁴

“[...]”

Q But was not it [sic] quite dangerous work for these inmates to go into these chambers and work among the bodies and among the gas fumes?

A No.

Q Did they carry gas masks?

A They had some, but they did not need them, as nothing ever happened. [...]”

Anyone who has ever grilled meat knows that fat cannot be scooped up from burning flesh. Fat ignites at approximately 184°C.⁴⁵⁵ It is therefore the first thing that burns on a corpse located in a fire. Hence, it is impossible to collect the easily combustible fat during the incineration of a corpse. After all, the bodies were burnt – not grilled.

The incineration of corpses in the open air with combustible fluids is impracticable because fluids have the property of flowing down or away and/or evaporating. When corpses, which consist of more than 60% water, are burnt, this must take place with the expenditure of quite large quantities of fuel and great heat. In particular, open oil or methane combustion would be insufficient.

The alleged attempt to destroy bodies by means of explosives requires no further comment. In reading such testimonies, one must inevitably wonder as to Höß’s mental condition in writing them, as well

⁴⁵³ Paul Blobel was the commander of unit 4a of *Einsatzgruppe C*, one of the German military units in Russia charged, among other things, with fighting partisans behind the Russian front. Mainstream historiography has it that in summer 1942 he was charged with the destruction of evidence of German mass murders in Eastern Europe (cf. http://en.wikipedia.org/wiki/Paul_Blobel). In the context of this task he allegedly made the ludicrous attempts at destroying corpses as stated by Höß. I will not dwell on this topic in this book.

⁴⁵⁴ Henry Friedländer, *The Holocaust*, Vol. 12: “The ‘finale solution’ in the extermination camps and the aftermath,” Garland, New York 1982, p. 113, Testimony of R. Höß, taken at Nuremberg, April 2, 1946.

⁴⁵⁵ J.H. Perry, *Chemical Engineer’s Handbook*, Wilmington Delaware 1949, p. 1584.

as that of anyone who takes such claims seriously. Unfortunately, such testimonies are the rule rather than the exception.⁴⁵⁶

Entering the “gas chamber” without a protective filter, eating and smoking in the “gas chamber,” as well as the commencement of the corpse dragging operation immediately after the opening of the doors, would only be conceivable, if there were no longer any dangerous quantity of gas in the chamber. The question of whether this was possible will be the subject of chapter 7.3.2.2.

It is interesting to note that M. Broszat deleted the last pages of Rudolf Höß’s testimony from his edition, since they contain “completely erroneous data on the numerical strength of these Jews,” as Broszat himself stated in a footnote. In these pages, Höß speaks of three million Jews in Hungary, four million in Romania, two million in Bulgaria. The actual figures were lower by a factor of approximately ten.⁴⁵⁷ In addition, the same pages contain the following, which is also incredible:⁴⁵⁸

“Although well-cared for and plentifully provided with bonus payments, one often saw them [the Jewish Sonderkommandos] dragging corpses with one hand, and holding and gnawing on something to eat with the other hand.

Even during the horrid work of digging up and burning the mass graves, they did not allow themselves to be disturbed while eating. Even the burning of their closest relatives could not shake them. [...]”

This is really a bit hard to digest. Höß was repeatedly tortured and abused by his captors.⁴⁵⁹ This may explain the absurdities he put down on paper – or was forced to sign. At any rate, it renders his statements inadmissible in any court of law – and should also render them unfit in the scientific community to serve as evidence for anything not independently confirmed by documents or material evidence.

Another commonly quoted witness is Henryk Tauber. Tauber was, according to his own testimony, a member of the inmate *Sonderkommando* of Crematorium II during the war. J.-C. Pressac writes that this

⁴⁵⁶ For a more detailed study in this regard, see A. Neumaier, “The Treblinka-Holocaust,” in G. Rudolf (ed.), *op. cit.* (note 24), pp. 471-500; C. Mattogno, J. Graf, *Treblinka*, Theses & Dissertations Press, Chicago 2004.

⁴⁵⁷ Intensive statistical studies in this regard were undertaken by W.N. Sanning, *op. cit.* (note 45); W. Benz, *Dimension des Völkermords*, Oldenbourg, Munich 1991; see also G. Rudolf, “Holocaust Victims: A Statistical Analysis · W. Benz and W. N. Sanning – A Comparison,” in: G. Rudolf (ed.), *op. cit.* (note 24), pp. 181-213.

⁴⁵⁸ J. Bezwinska, *KL Auschwitz in den Augen der SS*, Verlag des Staatlichen Auschwitz-Museums, Auschwitz 1973, pp. 135f.

⁴⁵⁹ Cf. G. Rudolf, *Lectures...*, *op. cit.* (note 451), pp. 382f.

eyewitness testimony is the best in relation to the crematoria, which he considers to be 95% reliable. This testimony contains the following:⁴⁶⁰

“During the incineration of such [not emaciated] corpses, we used the coke only to light the fire of the furnace initially, for fatty corpses burned of their own accord thanks to the combustion of the body fat. On occasion, when coke was in short supply, we would put some straw and wood in the ash bins under the muffles, and once the fat of the corpse began to burn the other corpses would catch light themselves. [...]

Later on, as cremations succeeded one another, the furnaces burned thanks to the embers produced by the combustion of the corpses. So, during the incineration of fat bodies, the fires were generally extinguished. [...]

Another time, the SS chased a prisoner who was not working fast enough into a pit near the crematorium that was full of boiling human fat. At that time [summer 1944], the corpses were incinerated in open-air pits, from which the fat flowed into a separate reservoir, dug in the ground. This fat was poured over the corpses to accelerate their combustion. [...]”

Tauber’s claims as to self-igniting, self-combustible corpses are completely absurd and in contradiction to all the laws of physics and engineering. He also confuses grilling with burning with relation to the allegedly boiling fat from the corpses. What is more, fat cannot boil at all. It simply begins to ignite at temperatures of approximately 180-190°C.

Tauber also proves himself a liar in the technical details related by him. He claims, for instance, that the *Sonderkommandos* shoved extraordinarily many corpses into each oven (up to eight) when they heard Allied planes approaching. Tauber claims that, by so doing, huge flames would have come out of the crematorium’s chimney, which they hoped would make the Allied bomber pilots aware of them. But as is common knowledge and has been pointed out many times, no flames ever come out of crematorium chimneys. It is also impossible to push eight corpses into a cremation muffle whose door is just two feet wide and high.⁴⁶¹ And apart from that, before Tauber and his co-inmates would have been able to push eight corpses into each oven and get a huge blaze going, any plane they claim to have heard approaching would have long since

⁴⁶⁰ Interrogation of Henryk Tauber dated May 25, 1945, annex 18, volume 11 of the Höß trial, quoted acc. to J.-C. Pressac, *op. cit.* (note 72), pp. 489f.; this testimony is rather typical; see also A. Neumaier, *op. cit.* (note 456), pp. 489-492.

⁴⁶¹ On a more thorough critique of Tauber’s testimony see C. Mattogno, *op. cit.* (note 76), pp. 375-424; on cremation technology, see C. Mattogno, “The Crematoria Ovens of Auschwitz and Birkenau,” in: G. Rudolf (ed.), *op. cit.* (note 24), pp. 373-412; C. Mattogno, *The Crematory Ovens of Auschwitz. A historical and technical study*, The Barnes Review, Washington, DC, in preparation.

flown far, far away. Such testimonies are, to use Pressac's words, nothing but downright lies and pure invention.⁴⁶²

Now to the testimony of the witness Richard Böck as quoted during the Frankfurt tribunal:³¹³

"One day, it was during the winter of 1942/43, H. asked me, whether I wanted to drive with him to a gassing action. [...]"

The transport train, which had already arrived, stood on the free stretch of track. [...]"

They were all loaded, and driven to a former farmhouse. [...]"

After the entire transport – there must have been approximately 1,000 people – was in the building, the door was closed. Finally, an SS man came, I believe it was a Rottenführer, to our ambulance and got out a gas canister. He then went to a ladder with this gas canister. [...] At the same time, I noticed that he had a gas mask on while climbing the ladder. [...] he shook [...] the contents of the canister into the opening. [...] When he had closed the little door again, an indescribable crying began in the chamber. [...] That lasted approximately 8-10 minutes, and then all was silent. A short time afterwards, the door was opened by inmates and one could see a bluish cloud floating over a gigantic pile of corpses. [...] At any rate, I was surprised that the inmate commando which was assigned to remove the bodies, entered the chamber without gas masks, although this blue vapor floated over the corpses, from which I assumed that it was a gas. [...]"

In winter of 1942/1943, no crematorium was operable in Birkenau (the first became operable in spring 1943). For this reason, the alleged victims of homicidal mass gassings in a farmhouse as attested to by Böck are supposed to have been cremated in open-air pits close to this farmhouse.

In view of our previous study of the subject, we can establish:

- According to professional air photo analyses of the decisive locations, there were no large cremation ditches, no fuel stockpile, no development of smoke or flames.⁴⁶³ Accordingly, the scenario of destruction is obviously false in this regard.
- One thousand people occupy a surface area of at least 200 m². According to eyewitness testimonies, the farmhouses had only half this much surface area, at the most.⁴⁶⁴

⁴⁶² J.-C. Pressac, *op. cit.* (note 72), pp. 469ff., on several claims made by the witnesses C.S. Bendel, M. Nyiszli, and H. Tauber.

⁴⁶³ See also J.C. Ball, *Air Photo Evidence*, Ball Resource Service Ltd., Delta, B.C., Canada 1992; idem, "Air Photo Evidence," in: Rudolf (ed.), *op. cit.* (note 24), pp. 269-282, here pp. 275-281; cf. C. Mattogno, *Auschwitz: Open Air Incinerations*, Theses & Dissertations Press, Chicago, IL, 2005.

⁴⁶⁴ J.-C. Pressac, *op. cit.* (note 72), pp. 161ff.; cf. C. Mattogno, *The Bunkers of Auschwitz*, Theses & Dissertations Press, Chicago 2004.

- Chapter 7.1.: Hydrogen cyanide is a colorless, invisible gas. Therefore, no “blue vapor floating over the corpses” could be seen. This passage is a sign of pure fantasy, obviously suggested by the German name of HCN, “*Blausäure*” (blue acid), which only relates, however, to the formation of the pigment Iron Blue.
- Chapter 7.2.: Since the events described are alleged to have taken place in winter, the rapidity of the procedure is incredible, since Zyklon B only releases gas slowly at frost temperatures.
- The described entry into chambers with a high concentration of toxic gas without a protective filter is impossible; such a manner of procedure would obviously sooner or later be fatal.

German public prosecutor Willy Dreßen had the following to say about Böck’s testimony:⁴⁶⁵

“Dear Mr. [...],

I enclose a copy of the eyewitness testimonies of former members of the SS on the gassing of inmates at Auschwitz [...] for your information. They are only a selection – there are numerous other such testimonies. In contrast to yourself, I am of the opinion that these eyewitness testimonies relating to the fact of the occurrence of gassings of human beings, are entirely suitable to refute the denial of this fact.

Faithfully, (Dreßen), Public Prosecutor”

And yet again: “Dear Mr. [...],

[...] Furthermore, the testimony of B ö c k is only one of numerous similar statements [...]

Faithfully, (Dreßen), Public Prosecutor”

Böck’s testimony was one of the few which the Frankfurt tribunal considered credible after careful examination, that is, the inconsistencies would not be so easily recognized by the layman, in contrast to the many other testimonies. And yet it is entirely incredible.

Pressac himself becomes very critical in quite a few of his passages relating to the reliability and credibility of eyewitness testimonies;⁴⁶⁶ yet it is upon these eyewitness testimonies that all the descriptions of the “gas chamber” killings are based. He lists the untruths, impossibilities, and exaggerations of the witnesses and explains how they presumably materialized. Finally, in an interview, he said:⁴⁶⁷

⁴⁶⁵ Letter from public prosecutor Willy Dreßen, Zentrale Stelle der Landesjustizverwaltung Baden-Württemberg, Ludwigsburg, ref. 110 AR 916/89, July 26, 1989, and Oct. 11, 1989, respectively; see also the book by Ernst Klee, Willy Dreßen, *Schöne Zeiten*, S. Fischer, Frankfurt 1988: Engl.: *The Good Old Days*, Free Press, New York 1991.

⁴⁶⁶ J.-C. Pressac, *op. cit.* (note 72), pp. 124-128, 162, 174, 176f., 181, 229, 239, 379f., 459-502. For additional eyewitness testimonies, see also note 458 and E. Kogon *et al.*, *op. cit.* (note 46), pp. 194-239.

⁴⁶⁷ *Focus* no. 17/1994, pp. 118, 120.

“No, no. One cannot write serious history based only upon eyewitness testimonies.”

At the same time, however, he bases all of his remarks on the alleged existence of homicidal “gas chambers” exclusively on these eyewitness testimonies! And elsewhere, he states, with a naiveté which can hardly be surpassed:⁴⁶⁸

“Witnesses never lie, but they can be mistaken.”

Pressac seems to be the only person of the establishment who takes notice of the progress of revisionist research. He knows that traditional historiography of the Holocaust is reduced to absurdity by the facts revealed by this research. Consequently, he keeps changing his attitude when making public statements. The most vehement attack of the (once) media darling Pressac on the dominating historiography occurred during an interview published as an appendix to a PhD thesis analyzing the history of Holocaust revisionism in France. In it, Pressac described the established historiography of the Holocaust as “rotten” and stated:⁴⁶⁹

“Can we alter the course? It is too late. A general correction is factually and humanely impossible [...]. New documents will unavoidably turn up and will overthrow the official certainties more and more. The current view of the world of the [National Socialist] camps, though triumphant, is doomed. What of it can be salvaged? Only little.”

In his first and so far most comprehensive book, Pressac is compelled to correct the statements of witnesses in many cases in order to eliminate errors and, in his opinion, technical impossibilities. But when so doing, he never reveals the basis upon which he undertakes these corrections. In actual fact, he merely replaces the capriciousness of “eyewitnesses” with his own. Thus, the numbers of victims per gassing procedure, as estimated by Pressac, for example, are considerably lower than those estimated in the eyewitness statements, which often speak of several thousand victims per gassing operation per day for Crematoria II and III. One thousand people could only have been made to enter a cellar with a surface area of 210 m² under the maintenance of extraordinary discipline accompanied by a readiness to cooperate(!) on the part of the victims (see chapter 7.3.2.1.1.). The numbers of people reported in places by witnesses, on the other hand (2,000 and more⁴⁷⁰), could not have been contained by Morgue 1. To arrive at the number of victims of Auschwitz-Birkenau, as spread by sensationalist media and literature

⁴⁶⁸ *Die Woche*, Oct. 7, 1993, p. 8

⁴⁶⁹ In: Valérie Igounet, *Histoire du négationnisme en France*, Editions du Seuil, Paris 2000, p. 652. I thank R. Faurisson, who made me aware of this interview.

⁴⁷⁰ 2,000 according to R. Höß (H. Friedländer, *op. cit.* (note 454), S. 112), as well as C.S. Bendel, 3,000 according to M. Niyzli, see note 462.

until the late 1980s – four million – one is in fact compelled to resort to technically impossible figures of “gas chamber” occupancy, as the witnesses do – which proves that they were not reporting true events but were aiming at supporting a myth.

At the moment, the official estimates range from approximately 1 to 1½ million victims,⁴⁷¹ though in his second book, Pressac downgraded the “gas chamber” victims to 630,000⁴⁷² and later even further down to 470,000-550,000.⁴⁷³ In an article published in a small German periodical in early 2002, a German mainstream journalist even attempted to reduce the death toll of the Auschwitz “gas chambers” down to as little as 356,000.⁴⁷⁴ But as long as this revolutionary development is not accepted by most scholars, we will stick to the number of one million “gas chamber” victims for all further considerations.

The following is a description of the homicidal gassing procedures for the individual installations, if one were to assume that one million human beings were actually gassed:

- Crematorium I: Blocking the crematorium environs to third parties; 500-700 victims undressing in open air (what a spectacle for all other inmates!); entry into “gas chamber” (morgue) near oven room; on their way to the “gas chamber,” victims march past piles of corpses of earlier victims or “naturally” deceased inmates; introduction of Zyklon B through (non-existing) roof vents with utilization of gas masks after closure of doors; turning on of ventilators and opening of doors after death of victims (approximately five min.); removal of corpses from gas chambers without gas masks; cremation of victims.⁴⁷⁵ According to Pressac, only a few gassings occurred, with a total of only 10,000 victims.⁴⁷⁶
- Crematoria II/III: Entry of 800 to 1,200 victims into western entrance stairway into Morgue 2; undressing; travel through stairwell into Morgue 1 (“gas chamber”); introduc-

⁴⁷¹ On the origin of the 4 million propaganda figure see C. Mattogno, “The Four Million Figure of Auschwitz,” 2 parts, *The Revisionist* 1(4) (2003), pp. 387-392; *ibid.*, pp. 393-399.

⁴⁷² J.-C. Pressac, *Les crématoires d’Auschwitz*, *op. cit.* (note 95), p. 147.

⁴⁷³ J.-C. Pressac, *Die Krematorien von Auschwitz*, *op. cit.* (note 95), p. 202.

⁴⁷⁴ F. Meyer, *op. cit.* (note 329). For an overview of the wide range and development of claims about the Auschwitz death toll, see Robert Faurisson, “How many deaths at Auschwitz?,” *The Revisionist*, 1(1) (2003), pp. 17-23.

⁴⁷⁵ J.-C. Pressac, *op. cit.* (note 72), p. 125.

⁴⁷⁶ *Ibid.*, pp. 131f.

tion of Zyklon B through (non-existing) roof vents either onto the floor or into (non-existing) wire-mesh pillars with utilization of gas masks; turning on ventilators after death of victims (approximately five min.); opening of doors after approximately 20 minutes; hosing down of corpses, soiled with blood, vomit and excrement; removal of bodies with or without utilization of gas masks; no protective garment; cutting of hair and removal of gold teeth while bodies are still in cellar; transport with lift (payload 300 kg⁴⁷⁷) to ground floor; there, transport through water-filled channels to ovens; cremation.³¹⁸ Approximately 400,000 victims for Crematorium II, 350,000 for Crematorium III according to Pressac.⁴⁷⁸

Crematorium IV/V: Undressing of a few hundred victims in open air (again: what a spectacle for all other inmates!), otherwise in morgue, some of them next to corpses of last gassing victims (or “naturally” deceased inmates) awaiting cremation; entry into “gas chambers” past coal room and doctor’s office; evacuation of the entire building; introduction of Zyklon B through hatches from a ladder after closure of door(s) (despite iron bars in front of those openings); opening of doors after 15 to 20 minutes; removal of corpses to morgue or to cremation ditches behind Crematorium V by the *Sonderkommando*, some of them wearing gas masks, some not. According to Pressac, the number of victims can only be estimated with difficulty, probably approximately 100,000.⁴⁷⁹ A similar scenario applies to farmhouses I and II (see chapter 5.4.3.).

7.3.1.3. Quantities of Poison Gas

7.3.1.3.1. Overview

Opinions differ as to the concentration of poison gas alleged to have been used in the presumed executions (see next chapter). The only indi-

⁴⁷⁷ Crematory II only received a make-shift elevator, see C. Mattogno, *op. cit.* (note 76), p. 53.

⁴⁷⁸ J.-C. Pressac, *op. cit.* (note 72), p. 187.

⁴⁷⁹ *Ibid.*, pp. 384-390.

rect sources available to us are the alleged execution times reported by the eyewitnesses, which in turn permit a crude estimate of the concentrations used. These reported execution times all allege a gassing time of only a few minutes.⁴⁸⁰

Assuming an execution time approximately corresponding to those in U.S. execution gas chambers (ten minutes and more until cardiac

⁴⁸⁰ With relation to the killing times, see in, for example: Schwurgericht Hagen, verdict from July 24, 1970, ref. 11 Ks 1/70, p. 97 (5 min.); Final Trial Brief of the Prosecution, quoted acc. to U. Walendy, *Auschwitz im IG-Farben-Prozeß*, op. cit. (note 161), pp. 47-50 (3 to 15 minutes in extreme cases); E. Kogon et al., op. cit. (note 46), ubiquitous (immediately up to 10 min., more rarely up to 20 min.); J. Buszko (ed.), *Auschwitz, Nazi Extermination Camp*, Interpress Publishers, Warschau²1985, in cooperation with the Auschwitz State Museum, pp. 114 + 118 (a few minutes); H.G. Adler, H. Langbein, E. Lingens-Reiner (ed.), *Auschwitz*, Europäische Verlagsanstalt, Cologne³1984, pp. 66, 80 + 200 (a few minutes, up to 10 minutes); Hamburger Institut für Sozialforschung (ed.), *Die Auschwitz-Hefte*, vol. 1, Beltz Verlag, Weinheim 1987, pp. 261ff. +294 (instantly, up to 10 min.); C. Vaillant-Couturier, in: *IMT*, vol. VI, p. 216 (5 to 7 min.); M. Nyszli in: G. Schoenberner (ed.), *Wir haben es gesehen*, Fourier, Wiesbaden 1981, p. 250 (5 min.); C.P. Bendel in: H. Langbein, *Menschen in Auschwitz*, Europaverlag, Vienna 1987, p. 221 (end of screaming of victims after 2 min.); P. Broad in: B. Naumann, *Auschwitz*, Athenäum, Frankfurt/Main 1968, p. 217 (4 min.), opening of doors after 10-15 minutes: A. Rückerl, *NS-Verbrechen vor Gericht*, C.F. Müller, Heidelberg,²1984, pp. 58f.; K. Höltinger in: H. Langbein, *Der Auschwitz-Prozeß*, Europäische Verlagsanstalt, Frankfurt/Main 1965, p. 73 (1 min.); R. Böck, *ibid.*, p. 74 (screaming victims for 10 minutes following closure of doors, followed by opening of doors, cf. note 313); H. Stark, *ibid.*, p. 439 (screaming victims for 10-15 minutes); F. Müller, *ibid.*, p. 463 (8-10 min.); E. Pyš, *ibid.*, p. 748 (ventilators switched on after only a few minutes); K. Lill, *ibid.*, p. 750 (a scream a few seconds after the introduction of Zyklon B, pall of thick smoke exiting the chimney a few minutes later); transcript of the expert opinion of Prof. Dr. G. Jagschitz, 3rd-5th hearing days of criminal proceedings against Gerd Honsik, April 4., April 30, May 4, 1992, ref. 20e Vr 14184 and Hv 5720/90, District Court Vienna, p. 443 (2-3 min.); Dokument 3868-PS, *IMT* volume 33, p. 275ff., quoted according to L. Rosenthal, "Endlösung der Judenfrage," *Massenmord oder "Gaskammerlüge"?*, Verlag Darmstädter Blätter, Darmstadt 1979 (2 to 15 minutes in exceptional cases); R. Höß, op. cit. (note 311: he mentions 30 minutes, after which the men of the *Sonderkommando* went into the chamber without gas masks, hence ventilation must have been included in that time, although Höß stated that it was turned on only at the time of entry – an impossible claim); Hans Münch, in G. Rudolf, "Auschwitz-Kronzeuge Dr. Hans Münch im Gespräch," *VffG*, 1(3) (1997), pp. 139-190 (2 to 5 min. in winter); Salmen Lewenthal, *Hefte von Auschwitz*, Sonderheft 1, *Handschriften von Mitgliedern des Sonderkommandos*, Verlag Staatliches Museum Auschwitz, 1972, p. 155 (sudden silence); Dov Paisikovic, in: Léon Poliakov, *Auschwitz*, René Julliard, 1964, pp. 159ff. (3-4 minute), Franke-Gricksch Report, in: J.-C. Pressac, op. cit. (note 72), p. 238 (one minute to kill the victims, another until the doors were opened); Rudolf Vrba alias Walter Rosenberg, Alfred Wetzler, ref. M 20/153, Yad Vashem (acc. to War Refugee Board, "German Extermination Camps – Auschwitz and Birkenau," in: David S. Wyman (ed.), *America and the Holocaust*, volume 12, Garland, New York/London 1990, p. 20 (everyone in the room was dead after three minutes); Jerzy Tabeau, in: *The Extermination Camps of Auschwitz (Oswiecim) and Birkenau in Upper Silesia* (10 minutes, quoted according to Enrique Aynat, *Los protocolos de Auschwitz. i Una fuente historica?* Verlag Garcia Hispan, Alicante 1990); André Lettich, *Trente-quatre mois dans les Camps de Concentration*, Imprimerie Union Coopérative, Tours, 1946 (a few moments). Janda Weiss, in: David E. Hackett, (ed.), *The Buchenwald Report*, Beck, Munich 1997, p. 394 (3 min.). If longer killing times appear in the eyewitness testimonies, they refer, not to Crematoria II and III, but, rather, to Crematoria IV/V, bunkers 1-2, or Crematorium I in the Main Camp. The killings in Crematoria II and III are therefore alleged to have been committed very quickly.

arrest at 3,200 ppm HCN, see chapter 7.1.), a concentration of at least 3,000 ppm ($3.6\text{g}/\text{m}^3$) would have had to have reached even the remotest corner of the chamber after only half this time (five minutes). With a free volume of 430 m^3 in Morgue 1 of Crematoria II and III,⁴⁸¹ this corresponds to a quantity of hydrogen cyanide of approximately 1.5 kg released and spread out after five minutes. Since the carrier material only releases approximately 10% of its hydrogen cyanide content after five minutes (see chapter 7.2.), at least ten times that amount would have been required in order to kill (or at least turn unconscious) in only a few minutes, *i.e.*, this would mean the utilization of at least 15 kg of Zyklon B.⁴⁸² This, of course, only applies on the condition that the hydrogen cyanide released reached the victims immediately, which cannot be expected in large, overcrowded cellars. It must therefore be considered established that quantities of at least 20 kg of Zyklon B per gassing (ten 2 kg cans or twenty 1 kg cans) would probably have had to have been used for the gassing procedures described.

Let us state that the scenarios described by the witnesses would require a quick increase in the concentration of hydrogen cyanide *everywhere* in the chamber. At the same time, logically, there cannot have been a simultaneous drop in the hydrogen cyanide in the chamber – such as through the respiration of the victims. Such a loss in hydrogen cyanide would have had to have been overcompensated for through an even more rapid evaporation of fresh hydrogen cyanide, because the hydrogen cyanide concentration would have *had* to increase for rapid executions. After the end of respiration due to increasing numbers of dead victims, who died in a matter of minutes, this most important cause of a loss in hydrogen cyanide would have ceased to exist as a factor. But since Zyklon B continues to give off large amounts of hydrogen cyanide for many more minutes, it must be assumed that the hydrogen cyanide content in such chambers would continue to increase constantly, and very rapidly, during the first quarter hour at least. Since deadly concentrations (3,200 ppm) would have had to have been reached even in the remotest corner of the chamber already after a few minutes, this means that the hydrogen cyanide concentration inside the chamber after approximately one quarter hour would have exceeded 10,000 ppm and would have continued to rise thereafter – slowly, of course, but nevertheless constantly at all times.

⁴⁸¹ 504 m^3 empty volume of the cellar minus 75 m^3 occupied by 1,000 persons.

⁴⁸² At least because the initial evaporation of the hydrogen cyanide would have led to an immediate condensation of the environmental humidity onto the carrier, more or less interrupting the further evaporation of hydrogen cyanide; see also chapter 7.2.

To assume that the respiration of the victims locked in the chambers would have been capable of perceptibly reducing the concentration of hydrogen cyanide in the air is therefore entirely in contradiction to the eyewitness statements.⁴⁸³ In particular, this would have required that the victims, confined in the chamber, could have acted as quasi-living filters for the greater proportion of the time during which the Zyklon B was releasing hydrogen cyanide (at least one hour). But one thousand people locked in a hermetically sealed cellar would have died in an hour from lack of oxygen alone.

These considerations show that a concentration of hydrogen cyanide in Morgue 1 of Crematoria II and III during the alleged gassings would have had an effect on the masonry which would have been at least as great as that occurring during disinfestation. High rates of hydrogen cyanide absorption would have to be expected during these periods, particularly on the cool and moist masonry of cellars in Crematoria II and III. The duration of the gassing period would have depended above all on the subsequent ventilation, which will be examined below.

7.3.1.3.2. Excursus 1: Poisoning or Suffocation?

Because eyewitness statements about the amount of Zyklon B are rare, and since humans are more sensitive to HCN than insects (see chapter 7.1.), some scholars opine that only small amounts of Zyklon B were used for the alleged mass murders in Auschwitz, for example J. Bailer,⁵⁸ W. Wegner,⁵³ and G. Wellers,⁵⁹ who assume an applied concentration of 1 g per m³ (0.083 vol.%) or less.

R.J. Green argues that an amount was applied which would have corresponded to some 0.45-1.8 vol.% after the *complete* release of all HCN from the carrier. He argues that this would have sufficed to kill everybody inside within a few minutes, as a lethal concentration of 0.045-0.181 vol.% would have been reached by then. At the time the ventilation was switched on (some 30 min later), a concentration of about 0.09-0.72 vol.% would have been reached.⁷⁰

The few witnesses statements we have claim that several kilograms of Zyklon B were used.⁴⁸⁴ In his book, Pressac frequently refers to a

⁴⁸³ Such is, for example, the hypothesis brought forth by G. Wellers, *op. cit.* (note 59), which is similarly incorrect in its findings, due to the incorrect hypothesis that lower quantities of Zyklon B were used: J. Bailer, *op. cit.* (note 56); W. Wegner, *op. cit.* (note 53).

⁴⁸⁴ J. Buszko (ed.), *op. cit.* (note 480), p. 118: 6 to 12 kg; Léon Poliakov, *Harvest of Hate*, Greenwood Press, Westport, Conn., 1971, p. 205: 5-7 kg; an analysis of the eyewitness statements has been undertaken by D. D. Desjardin: "Kenneth Stern's Critique of The Leuchter Report: A Critical Analysis," www.codoh.com/newrevoices/nddd/ndddstern.html. The analysis does not, however, take account of the slow release of hydrogen cyanide by the carrier material. See also

HCN end concentration of 12 g per m³ or 1 vol.% used for executions.⁴⁸⁵ He backs this up with witness accounts, according to which four to six 1-kg cans of Zyklon B were allegedly poured into the “gas chambers” (morgues) of Crematorium II and III, which indeed corresponds to a concentration of 1 vol.%.³¹⁸

Pressac, on the other hand, assumes that 95 to 98% of the entire Zyklon B delivered to the camp was used for the original purpose, *i.e.*, for delousing clothes and rooms,⁴⁸⁶ for which he relies on statements from the Nuremberg tribunal.⁴⁸⁷ Pressac justifies this with the fact that, in relation to other concentration camps, where doubtlessly no extermination took place, the Auschwitz camp did not receive higher amounts of Zyklon B deliveries, if seen in relation to the number of inmates and in relation to the material delousing facilities that doubtlessly operated there.

The supply figures of the Auschwitz camp can be found in the protocols of the International Military Tribunal Nuremberg. In total, they reached some 19,000 kg during the years 1942 and 1943.¹⁶¹ The total supplied amount during the entire existence of the camp from late 1940 to early 1945 will hardly have exceeded 40 tons. According to Pressac’s statement that not 2-5% of this was used for killings, 800 to 2,000 kg of the total delivery was used for extermination of humans.

But when dividing up this amount of Zyklon B for one million people allegedly killed with it, with 1,000 victims per gassing – the “gas chambers” (morgues I) of Crematorium II and III could hardly hold 1,000 persons per execution – only roughly 0.8 to 2 kg HCN was available for each gassing. With the morgues’ free volume of roughly 430 m³,⁴⁸¹ and after all hydrogen cyanide had evaporated from the carrier (after more than an hour), 800 to 2,000 g of hydrogen cyanide would result in a theoretical end concentration of 1.86 to 4.65 g per m³, which means that the concentration during the first five or ten minutes was much lower.

If, on the other hand, one million victims were killed according to the eyewitness statements, *i.e.*, with high concentrations in a few mi-

Desjardin’s interview with F. Piper, *op. cit.* (note 169), where Piper talks about 6 kg per 1,400 victims.

⁴⁸⁵ J.-C. Pressac, *op. cit.*, p. 18.

⁴⁸⁶ J.-C. Pressac, *op. cit.*, pp. 15 and 188.

⁴⁸⁷ Office of Chief of Counsel for War Crimes, British Military Tribunal, trial against B. Tesch *et al.*, Hamburg March 1-8, 1946, Document No. NI-12 207, quoted acc. to: U. Walendy, *op. cit.* (note 161), p. 83. Note: No staff member of the former Zyklon B producers was ever convicted, because there was no evidence linking them to a crime: Degussa AG (ed.), *Im Zeichen von Sonne und Mond*, Degussa AG, Frankfurt/Main 1993, pp. 148f.

nutes, those 1,000 gasings would have required $1,000 \times 20 \text{ kg} = 20$ tons of Zyklon B, or at least 50% of the entire Zyklon B delivery to the camp.

This shows an obvious inconsistency in Pressac's statements. One cannot have both high concentrations during homicidal gasings and a low percentage of the entire Zyklon B delivery to Auschwitz used for these gasings.

Let us now have a closer look at the theory endorsed by J. Bailer,⁵⁸ W. Wegner,⁵³ and G. Wellers,⁵⁹ that only a small amount of HCN was used for the killings. In such a case, the concentration reduction due to the respiration of the victims is no longer a negligible quantity.

Per capita, the respiration of HCN is the higher, the higher the applied concentration is. The reason for this is that, although the victim incorporates lethal amounts of hydrogen cyanide in short periods of time in case of high concentrations, their organism's reaction is delayed. During this delay, the victim incorporates more overdoses of hydrogen cyanide.

Graph 10 shows the behavior of the breathing volume per minute of persons dying of suffocation or poisoning (biochemical suffocations). Respiratory arrest occurs at the end of this period of time (at 5). Death occurs only several minutes after respiratory arrest. If one assumes a time period of 5 minutes until respiratory arrest, the assumed breathing volume during each single minute is: 1st: 20 liters; 2nd: 30 liters; 3rd: 50 liters; 4th: 80 liters; 5th: 30 liters.⁴⁴¹ In total, this yields a breathing volume of ca. 210 liters. Furthermore, we assume that the function is independent of the length of time until respiratory arrest. This means that double the amount of air is inhaled if the time period would be doubled.

Regarding Morgue 1 ("gas chamber") of Crematorium II, we have the following data: Volume: 504 m^3 ; volume of 1,000 persons: ca. 75 m^3 ; resulting free air volume: ca. 430 m^3 . First, the oxygen content in

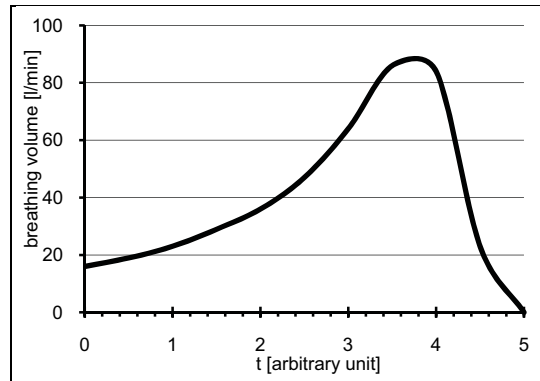

Graph 10: Schematic representation of the breathing volume behavior relative to time in case of suffocation/poisoning.

the room may be studied. In Table 9, the total inhaled volume of 1,000 victims is given in m^3 and multiples of the free air volume as a function of time. The average oxygen content is reduced by 20-30% per inhalation. This results in the remaining oxygen content in the chamber as given in the last two columns. Oxygen contents below 6% are lethal.⁴⁸⁸ So, even without adding any toxic gas, we have to reckon with the victims being suffocated in an airtight chamber already after some 45-60 minutes.

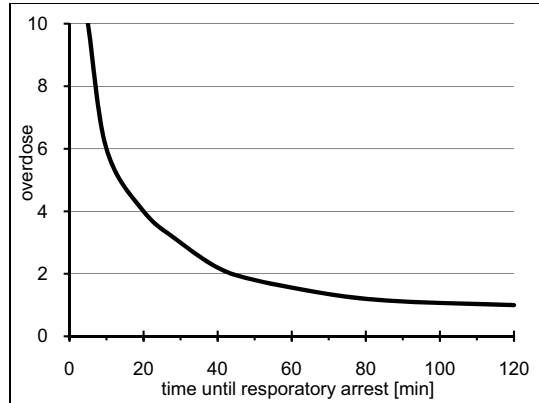

Graph 11: Incorporated amount of HCN as function of time until respiratory arrest in overdoses of lethal dose (ca. 80 mg).

Due to the extremely high capability of the lungs to absorb HCN, the human lung acts like a perfect filter which absorbs all hydrogen cyanide out of the air. Taking the experiences of U.S. execution “gas chamber” as a base, death occurs after some 10 minutes at the earliest in case of an application of ca. 4 g HCN per m^3 . In assuming a total inhaled volume of ca. 210 liters, this corresponds to an incorporated amount of HCN of ca. 800 mg, which is a tenfold overdose of the lethal dose (80 mg/person). In the following, it is assumed that in an execution lasting several hours, no overdoses of HCN are incorporated. Using these benchmark figures, a relation between incorporated overdose and execution time results as shown in Graph 11.

The HCN content in the air of a room decreases similarly by breathing as by ventilation (exponential behavior, see chapter 7.3.2.2.2.). If the victims have inhaled the entire room volume once, the HCN content will be reduced to ca. 37% of the initial value. As a function of time passed until respiratory arrest occurs, Table 10 shows how much HCN was incorporated by the victims in total (column 3), which portion of the total content of HCN in the air this is (column 4), how much HCN had been released in total (column 5), and how much Zyklon B at a carrier temperature of 15°C had to have been applied to release that

⁴⁸⁸ Y. Henderson, H.W. Haggard, *Noxious Gases*, Reinhold Publishing, New York 1943, pp. 144f.; J.S. Haldane, J.G. Priestley, *Respiration*, Yale University Press, New Haven 1935, pp. 223f.

Table 9: Reduction of O₂ content
in air-tight Morgue 1 as a function of time

Time until respiratory arrest [min]	Inhaled volume of 1,000 victims [m ³]	in free volumes of the room	Reduction of O ₂ content (30% per Inhalation)	Reduction of O ₂ content (20% per inhalation)
5	210	0.5	17.9	18.9
10	420	1	15	16.8
20	840	2	10.5	13.4
30	1,260	3	7.4	10.8
45	1,890	4.5	4.2 (lethal)	7.8
60	2,520	6		5.5 (lethal)
120	5,040	12		

much HCN as is required in this period of time. The last column shows the ratio of the inhaled amount of HCN and the applied amount. In so doing, it was assumed that the HCN concentration was available to every victim right from the start. In reality, the applied amount of hydrogen cyanide had to be a bit higher than assumed here (delay due to release and distribution of hydrogen cyanide).

According to testimonies, the execution times until all victims seemed dead – which means they were at least unconscious – were shorter than 10 minutes.⁴⁸⁰ When considering the delays caused by the release of the gas and its distribution, as well as the fact that death occurs only several minutes after respiratory arrest, the first two lines of Table 10, corresponding to execution times of ca. 10 and 15 minutes, respectively, are at the upper limit of witness accounts. This means that an execution within a few moments or minutes would have required enormous amounts of Zyklon B. Such witness accounts are therefore unrealistic. Furthermore, it must be assumed that, with the execution times attested to, only a fraction of the applied (<10%) and at the execution time released amount of hydrogen cyanide (<60%) actually could have been incorporated by the victims. The rest was available to react with the walls, among other things. Therefore, one has to reckon with high adsorption rates of hydrogen cyanide especially at the cool and wet walls of the cellars of Crematorium II and III, contrary to Weller's hypothesis, according to which this is not supposed to happen.⁵⁹ According to his opinion, the little amounts of hydrogen cyanide applied were supposedly inhaled entirely. This contradicts the witness accounts of the quick "gas chamber" death, which required large amounts of hydrogen cyanide.

Table 10: Amount of HNC as a function of execution time
(lethal dose = 80 mg/person = 80 g/1,000 persons)

Time until respiratory arrest [min]	Over-dose	Inhaled Amount of HCN [g]	Portion of released HCN [%]	released amount of HCN from carrier [g]	Applied Zyklon B (15°C) [g]	HCN _{inhaled} /HCN _{applied} [%]
5	10	800	40	2,030	28,600	3
10	6	480	63	760	5,000	10
20	4	320	86	370	1,230	26
30	3	240	95	252	625	38
45	2	160	99	161	320	50
60	1.5	120	100	120	200	60
120	1	80	100	80	100	80

Finally, the application of small amounts of hydrogen cyanide of an end concentration of only 1g/m³, *i.e.*, the use of only some 400 g Zyklon B per gassing, would have been senseless, if the facilities were indeed air-tight, which would have been imperative for their use as a mass “gas chamber.” This is, because the victims would have died in a similar period of time due to lack of oxygen anyway (cf. Table 9).

7.3.1.3.3. Excursus 2: HCN Loss due to Adsorption

It is worth taking a look into the HCN losses caused during disinfections due to adsorption on walls and clothes, as well as due to leaks. Puntigam *et al.*¹²⁶ describe the hydrogen cyanide concentration behavior at different locations of a delousing chamber with and without air circulation (“*Kreislaufverfahren*”). Puntigam neither gives measures and loading of the chamber, nor the type of carrier material and its distribution, nor the temperature. Since the different measuring points show different concentrations peaks, this indicates a non-even distribution of the products in the chamber. For the sake of clarity, only the concentration behavior in the center of the room is reproduced in Graph 12.

The loss of hydrogen cyanide as a function of temperature in a disinfection chamber can be seen in Graph 14. The higher losses at lower temperatures is caused by a higher moisture content in the gassed material and in the walls of the observed room.¹²⁷

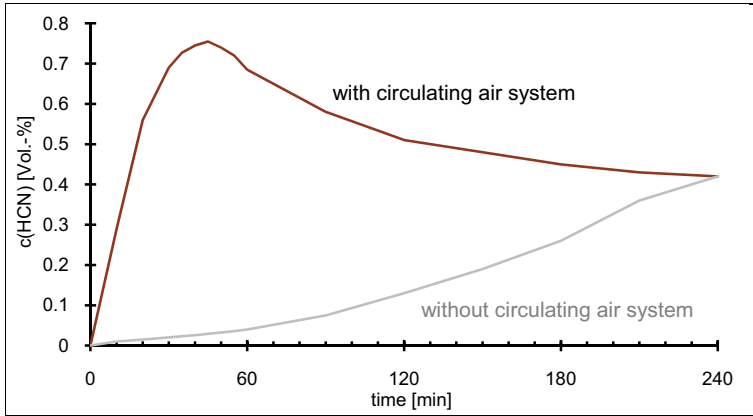

Graph 12: Hydrogen cyanide concentration behavior in delousing chamber with and without circulating air systems, measuring points always in center of room (intern. correspondence of Degesch; values at various points differed greatly).¹²⁶

According to the already quoted publication by Schwarz *et al.*,⁴²⁷ their measurements were made in the range of room temperature. Although the interesting part of Graph 13 is only poorly resolved, it is nevertheless clear that under these circumstances the maximum concentration is reached as late as 4 to 5 hours after the start. In these years, circulating air systems did not yet exist, so that only the natural air convection was responsible for distributing the gas. Remarkable is the strong concentration reduction due to adsorption on the load, here lifeless material to be deloused. Due to the slow increase towards the maximum concentration, it must be assumed that Puntigam's values without circulating air system (Graph 12, lower curve) were achieved at similar

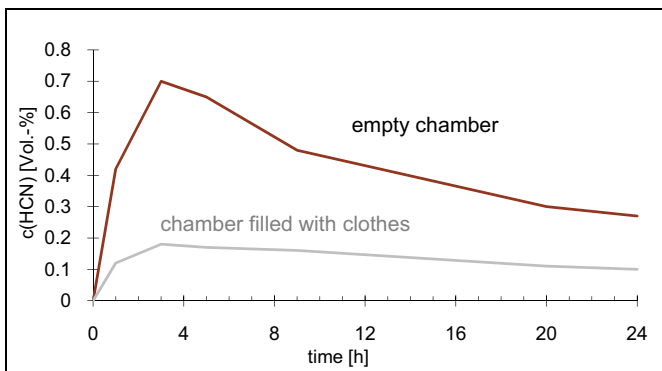

Graph 13: Hydrogen cyanide concentration behavior in disinestation chamber with and without clothes at room temperature.⁴²⁷

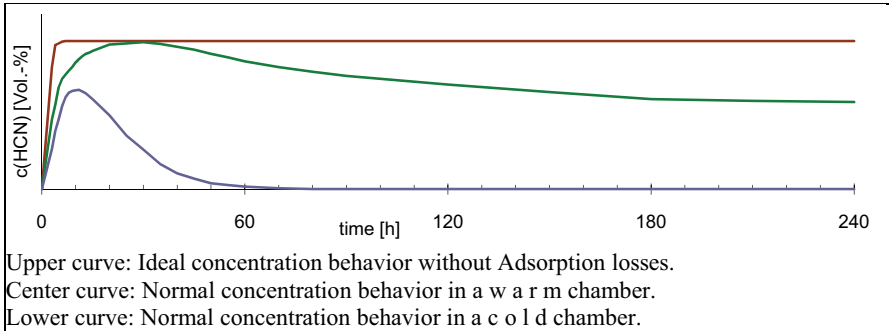

Graph 14: Relation between hydrogen cyanide adsorption on clothing and temperature in a delousing chamber with circulating air system (schematic).¹²⁷

temperatures.

In case of hypothetical homicidal gassings, the sweat produced by the frightened, crowded people and their HCN absorption through skin and lungs will cause similar losses, and in case of the underground morgues of Crematorium II and III, additional losses will occur due to the cold and moist walls.

In order to kill all victims quickly, as attested to by the “eyewitnesses,” such losses would have to be compensated by introducing even more HCN than calculated before (chapter 7.3.1.3.1. and 7.3.1.3.3.) in order to quickly reach *and maintain* high HCN concentrations everywhere in the “gas chamber.”

7.3.2. Critique of the Eyewitness Descriptions

7.3.2.1. Theatre of the Absurd

First, a few critical remarks on three topics of eyewitness statements relating to homicidal mass gassings should be made at this point.

7.3.2.1.1. Necessity of Cooperation

Just imagine the following scene: 1,000 people of both sexes plus children enter the undressing room with a surface area of 390 m² (4,200 ft², Morgue 2 of Crematoria II & III). Each one would therefore have an area of only 60 cm × 60 cm (2×2 ft) in which to undress. Experience shows that people do not pack themselves tightly to the very edge of an enclosed area, unless, of course, they are quite willing to do so.⁴⁸⁹ In order to get people to do this, the procedure must be rehearsed; they

⁴⁸⁹ Just think of street cars or buses, where everyone remains near the door, even though there is plenty of room at the rear.

must be aware of what is happening and what steps they must follow – and they must be willing to cooperate.

Alternatively, few people could be made to undress at a time, but this assumes that the people who have already undressed are in the “gas chamber” and waiting patiently for the next arrival of naked inmates. Once inside the “gas chamber,” the same problem occurs again. Here each individual has only an area of 45 cm × 45 cm (1.5×1.5 ft) in which to stand. The people must press themselves tightly together; the first people entering the room must proceed to the end of the room in a disciplined manner and line up against the wall. The next lot will form the line directly in front, and so on, until the entire chamber is full, which must have taken approximately half an hour, even with perfect choreography. Without perfection, we quickly reach an hour or more.

How did they get these 1,000 people to pack themselves tightly together, as one can expect from soldiers who have practiced this for weeks on a parade ground? The only solution is that this must have been practiced just as intensively and disciplined as soldiers do it. And of course, at some point in this alleged scenario, people had to realize that they were *not* gathering for a shower, thus resulting in panic and lack of orderly cooperation with their murderers’ procedures.

Finally, let us assume that those “gas chambers” were hermetically sealed. While it was filling up with people over an hour with the door at one end standing open, how would the air quality have developed in that tightly packed room? When the “gas chamber” was not even half-way filled with victims, the people standing at the rear wall must have had the first mild symptoms of suffocation due to oxygen depletion. How do you keep people who run out of air to stay where they are for another half an hour until everybody is ready? Or did the SS have the courtesy and foresight to turn on the ventilation while the room was filling, so that fresh air was being supplied? They better had...

7.3.2.1.2. Failure to Separate the Sexes

All eyewitness accounts known to the author are unanimous in claiming that the victims were not separated by sex before being sent into the “gas chambers.” The eyewitness accounts of the failure to separate the sexes are incredible for the following four reasons:

1. This procedure is in contradiction to the procedures followed during disinfection, where, according to the same witnesses, the sexes were carefully separated.⁴⁹⁰

2. Since there were always two alleged “gas chambers” of each type available in Birkenau (in Crematorium II and III, or IV and V, or bunker I and II), there is no apparent reason why the victims could not have been separated by sex.

3. The claims were repeatedly made that the victims were made to believe that they were going to shower or undergo disinfection. These procedures would have necessarily separated the populace on the basis of sex, if only because of the need for deception.

4. Particularly in the 1940s of last century, large numbers of people could only have been made to disrobe completely with others of the opposite sex if they had been threatened with force and violence. But this would have nullified all the other measures of concealment.

7.3.2.1.3. Towel and Soap

According to a few eyewitnesses, the victims were handed towels and bars of soap to make them believe that they were going to take a shower.⁴⁹¹ (Who, by the way, would go with a towel under a shower?) This statement becomes incredible given the chaos in the “gas chamber”: 1,000 corpses, 1,000 towels, and 1,000 bars of soap, plus vomit, urine, and blood from 1,000 victims! How was it possible to recycle those 1,000 bars of soap? How did they clean 1,000 towels? Did they waste 1,000 towels and 1,000 soap bars for every gassing? It can therefore be concluded that such accounts are untrue, and witnesses testifying about it are not trustworthy.⁴⁹²

7.3.2.2. Speed of Ventilation of the “Gas Chambers”

7.3.2.2.1. Introduction

An imaginary experiment may perhaps assist in clarifying a somewhat complicated mathematical relationship: you have a bucket filled to

⁴⁹⁰ See, for example, the pictures taken by the SS before and after delousing new arriving inmates, neatly separated by sex, as published in the Serge Klarsfeld (ed.), *The Auschwitz Album. Lilly Jacob's Album*, New York 1980.

⁴⁹¹ Cf. the testimony of André Lettich, Thèse Fac. Med., *Trent-quatre mois dans les camp de concentration*, Ed. Tours, impr. de l'Union cooperative, Paris 1946; quoted acc. to E. Kogon *et al. op. cit.* (note 46), p. 210.

⁴⁹² See also, in this regard, the detailed analysis of the testimony of SS Man Dr. Hans W. Münch: G. Rudolf, “Auschwitz-Kronzeuge...,” *op. cit.* (note 480).

the brim with sea water in front of you. You now take a second bucket filled with fresh water and pour it very carefully into the first bucket, allowing the excess to flow over the edge. Now the question: when you have emptied the second bucket of fresh water into the first, containing sea water, what is the composition of the water in the first bucket? Pure fresh water? Of course not. It will be a mixture of salt and fresh water.

7.3.2.2.2. Excursus

In mathematics, the equation related to this problem is called a linear, homogenous differential equation.

In general, the following time behavior applies for the concentration change of a substance i with time, dc_i/dt , in case of air exchange, provided that the newly added gas (free of i) is ideally mixed with the old gas:

$$\frac{dc_i}{dt} = -a \cdot c_i(t) \quad (8)$$

i.e., that the concentration change of substance i is proportional to the concentration $c_i(t)$ at time t . A modification of the equation yields:

$$\int \frac{1}{c_i(t)} dc_i = \int -a \cdot dt \quad (9)$$

After integration over dc and dt , resp., this yields:

$$\ln(c_i(t)) = a' - a \cdot t \quad (10)$$

or

$$c_i(t) = a'' \cdot e^{-at} \quad (11)$$

For $t = 0$, $e^{-at} = 1$ and thus

$$a'' = c_i(t=0) = c_0 \quad (12)$$

with c_0 as initial concentration (when the ventilation is started). This leads to:

$$c_i(t) = c_0 \cdot e^{-at} \quad (13)$$

From equation (8) results the initial concentration change $dc_i(t=0)/dt$:

$$\frac{dc_i(t=0)}{dt} = -a \cdot c_0 \quad (14)$$

Hence, we get for the constant a :

$$-a = \frac{dc_i(t=0)}{(dt \cdot c_0)} \quad (15)$$

In case of a sufficiently low exchange volume dv per time interval dt , the ratio of total volume V to the exchange volume dv can be introduced as initial concentration change (in case of infinitesimal transition ($dt \rightarrow 0$) this is mathematically correct). For example, if the air exchange per time unit is $1/1,000$ of the total, the concentration change per time unit is $1/1,000$, too. This turns (15) into

$$-a = \frac{dv}{(dt \cdot dV)} \quad (16)$$

After the time $t = \frac{V \cdot dt}{dv}$, the complete volume is exchange one time. Therefore, a is the reciprocal of the air exchange time:

$$a = \frac{1}{\text{exchange time}} \quad (17)$$

After a single air exchange, the concentration is:

$$c_i(t) = c_0 \cdot e^{-1} \approx 0.37 \cdot c_0 \quad (18)$$

For the $1/x$ -value period (time period in which the concentration drops to $1/x$) the following applies accordingly:

$$t_{1/x}^1 = \frac{\ln(1/x)}{-a} \quad (19)$$

Example: If it is required to lower the value down to 1% of the initial value (12 g per m^3 , 1 vol.%, down to 120 mg hydrogen cyanide per m^3 , 0.01 vol.%), i.e., down to 1/100 of the initial value, this results to:

$$t_{1/100}^1 = \frac{\ln(1/100)}{-a} \approx 4.6 \times \text{air exchange time.} \quad (20)$$

The half-value period is:

$$t_{1/2} \approx \frac{0.693}{-a} \quad (21)$$

Therefore, the concentration has dropped down to half after roughly 2/3 of a complete air exchange. This is true, if the fresh and the old air are mixed perfectly. However, this is not necessarily the case, as there are two other possible scenarios:

1. Exchange of old gas only (linear, laminar flow along the entire cross-section of the room): air exchange time roughly identical with ventilation time: Technically not given in the facilities under consideration.

2. Exchange of mainly fresh gas (exhaust close to intake), areas of old gas partly not involved: ventilation time is a multiple of what is described above. In our case, this is certainly given for the areas between the corpses, since here almost no mixing of the gases takes place. Additionally, the unfavorable location of the air intakes to the exhausts leads to a partial exchange of fresh gas (air short circuit). This increases the ventilation time by a factor of two to four or more. The following chapter will determine which scenario was given in the alleged “gas chambers.”

7.3.2.2.3. Ventilation of the Morgues of Crematorium II and III

As shown above, when fresh air and stale air mix together, the concentration of the latter falls to only approximately 37% of the initial value after one complete air exchange, and to approximately 14% after a second exchange.

Data are only available on the ventilation installations in Crematoria II and III, so that at this point we have to ignore all other “gas chambers” in this regard.⁴⁹³ In chapter 5.4.1.2.4., the ventilation capacity of morgues 1 of Crematoria II and III was shown to have been 4,800 m³ per hour. With a volume of free air in the Morgue 1 of 430 m³, the volume of the room would be exchanged once in approximately 5-6 minutes.⁴⁸¹

For morgues 1 of Crematoria II and III under consideration at this point, however, a further problem arises. In particular, the ventilation intake has been installed only approximately 2 m away from the ventilation outlet in the same wall. The distance to the ventilation outlet on the opposite wall, however, is 7.3 m, *i.e.*, 3.5 times as far. The result, in these cellars, is a “ventilation short circuit,” especially if we assume that the victims of the alleged mass extermination are all tightly crammed together, especially in the middle of the room, which would further lengthen the fresh air pathway from one side of the cellar to the other. The air blown into the ventilation intake openings would therefore, for the most part, be immediately sucked out through the ventilation outlet openings located nearby.⁴⁹⁴ Therefore, it must be expected that the actual ventilation time would be increased in comparison to a perfect mixing of fresh air and stale air as a result of this poor design.

⁴⁹³ Crematorium I is deliberately left out of the discussion, since the mass murders allegedly committed there have, in the meantime, after all, been generally questioned.

⁴⁹⁴ A reasonable regulation would have been to install the ventilation inlets on one side of the room, and the ventilation outlets on the other side.

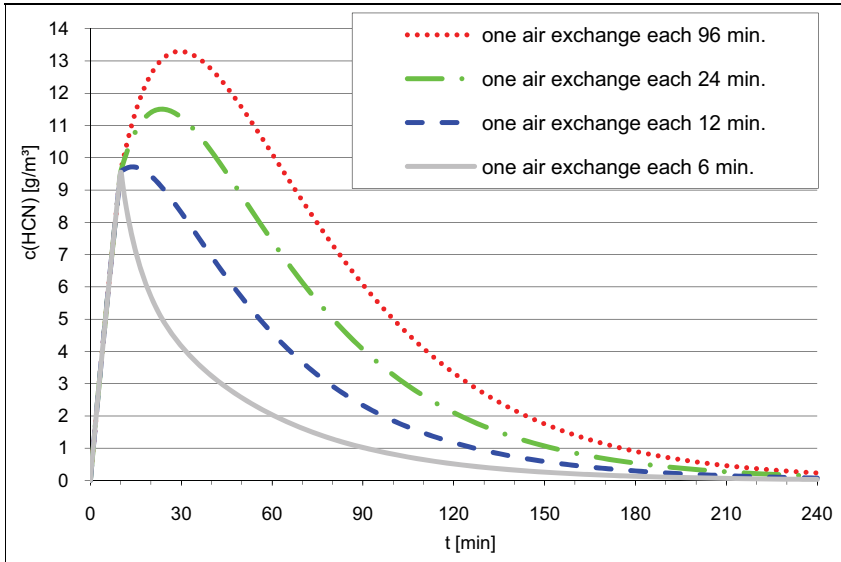

Graph 15: Simulation of the concentration of hydrogen cyanide in a hypothetical homicidal “gas chamber” of the type of Morgue 1 of Crematorium II in Auschwitz-Birkenau; see text.

In addition, if we assume that no wire mesh introduction columns existed, as has to be assumed from all extant material evidence, the following problem would also arise: the Zyklon B granules, which in the meantime would certainly have become moist, would lie trapped underneath the bodies in at least some places. To understand how this would effect the ventilation, we have carried out a simulation calculation based on the following assumptions:

1. At 15°C, Zyklon B releases hydrogen cyanide in the dry environment in the manner described by R. Irmscher (see chapter 7.2.). Although the air in the “gas chambers” would have been warmer than 15°C due to the victims’ body heat, it also would have had a relative humidity of 100%, plus the Zyklon B would have been lying on a wet floor. Both factors would have “seriously delayed” the release of HCN. Hence I will subsequently use the data for dry, finely dispersed Zyklon B at 15°C.
2. Reaching an *average* concentration of hydrogen cyanide throughout the entire chamber of approximately 5-6 g/m³ after 5 minutes and/or approximately 10-12 g/m³ after 10 minutes (0.5 or 1 vol.%) – necessary for the rapid killing of all victims according to the eyewitnesses – requires the use of approximately 20 kg of Zyklon B (see chapter 7.3.1.3.).

3. The ventilation is turned on after 10 minutes, reducing the concentration of hydrogen cyanide according to the well-known formula (see chapter 7.3.2.2.2.)

The results may be taken from the Graph 15 for four types of air exchanges differing in efficiency: one air exchange every 6, 12, 24 and 96 minutes.⁴⁹⁵ A few average values are listed in Table 11, taken from the individual scenarios. The value for 5g/m³ indicates, when the HCN concentration falls below a value at which it is possible to enter the chamber with a gas mask, but without protective garments and without performing physical work. The value for 2g/m³ should lie in the vicinity of a value permitting light physical work with a gas mask, but without protective garments. The value for 0.1g/m³ indicates when the HCN concentration falls below a concentration permitting entry of the chamber without a gas mask and without any health hazard. The column with the heading " $\int c(t) dt/10g/m^3$ " finally corresponds to a tenth of the surface area under the particular curve. The value corresponds to the duration of a hypothetical gassing of a chamber with a constant 10g/m³ HCN, when the hydrogen cyanide suddenly rises at the beginning of this period of time and then suddenly disappears at the end of this period. These values can be used for simulation calculations; see next chapter.

The 6 min/air exchange applies in the absence of a short circuit of the air in the chamber. The 12 min/air exchange corresponds to this necessary correction. Both cases assume an empty chamber. In fact, the

⁴⁹⁵ For those who wish to see it written out:

- a. Equation for release of HCN from the carrier material (in fractions):
 $A(t) = e^{-t/a}$
 - in which t = time after the initial release of HCN in minutes
 - in which a = 43.5/minutes (so as to attain the velocity and low atmospheric humidity at 15°C alleged by Irmscher, note 447)
- b. Equation for the reduction of the HCN content through ventilation:
 $B(t) = e^{-t/b}$
 - in which b = necessary time for a single air exchange of the room in question.
- c. Equation for the actual HCN content:
 - i. For the first 10 minutes (no ventilation, only release of HCN):
 $C1(t) = (1 - A(t)) \times D$
 - in which $D = e/f$
 - in which e = mass of Zyklon B introduced in grams
 - in which f = volume of the chambers = 430 m³ (net volume, without the volume taken up by the victims)
 - e has been selected so as to attain a concentration of approximately 10g/m³ after 10 minutes. For the sake of simplicity, I have used 20 kg = 20,000 g .
 - ii. Differential equation for the actual HCN content for times after 10 minutes, i.e., with ventilation, iteratively resolved into one minute steps:
 $C2(t+1) = C2(t) \times e^{-1/b} + (A(t) - A(t+1)) \times D$
 - in which $(A(t) - A(t+1)) \times D$ is the quantity of HCN evaporating from the carrier with each new minute.

Table 11: Some values of the ventilation efficiency of a hypothetical homicidal “gas chamber,” with Zyklon B remaining in the chamber, see text. Data in minutes.

Air exchange duration	t (5g/m ³)	t (2g/m ³)	t (0.1g/m ³)	∫c(t) dt/10g/m ³
6	24	61	192	35
12	56	97	228	63
24	81	123	254	90
96	100	144	278	118

ventilation of the intermediate area between the hundreds of bodies allegedly lying around on the floor, and the Zyklon B trapped underneath, will further slow the procedure to a considerable extent, so that, in relation to a hazard-free entry of the chamber, the truth will rather lie somewhere between cases two and four or beyond them.

It may be considered established that under no circumstances could these cellars be entered without a gas mask in less than 3-4 hours after the beginning of the gassing. Hard physical work with gas masks, but without protective clothes, *i.e.*, the alleged removal of the bodies, would not have been possible in less than 1½ to 2 hours.

If assuming – against all material evidence – the existence of Zyklon B introduction devices which allowed the removal of Zyklon after the end of the gassing, the resulting data would, of course, look dramatically different, see Table 12. Under such circumstances, it might have been possible to enter the “gas chamber” with a gas mask for hard labor already after 30 to 45 minutes, and without a gas mask within one to two hours. This would then lie at least within the range of some less extravagant eyewitness accounts. That explains also, why Pressac and van Pelt insist on the existence of these introduction columns, contrary to all physical evidence and despite the lack of any documentary proof and reliable witness testimony. Without those introduction columns, however, the scenarios described by eyewitnesses regarding a swift removal of the corpses from the “gas chamber” after the gassing are simply impossible.

These are, of course, only calculated guesses; if one were to ask me whether I would rely upon these values and enter such a “gas chamber” without a gas mask, I would reply that I preferred to insist upon the performance of a traditional chemical test beforehand. The simple reason for this is that all reliable calculation would be rendered impossible by the Zyklon B trapped beneath the bodies, as well as by the wet bodies moistened with hydrogen cyanide.

Table 12: Some values of the ventilation efficiency of a hypothetical homicidal “gas chamber,” with Zyklon B removed from chamber, see text. Data in minutes.

Air exchange duration	t (5g/m ³)	t (2g/m ³)	t (0.1g/m ³)	∫c(t) dt/10g/m ³
6	14	20	37	11
12	18	29	65	16
24	22	38	92	22
96	26	47	119	28

The rooms in Crematoria IV and V which purportedly served as “gas chambers,” like farmhouses I and II, allegedly had no ventilation installation and only slight ventilation possibilities by means of a few doors. The use of a room *without* efficient ventilation installations for mass murder at a time and in a place where even dissecting rooms, wash rooms, and laying-out rooms could be and were equipped with ventilation installations, and where many ventilation fans were supplying lots of fresh air in disinfestation rooms right next door, is so absurd that any rational human being ought to refuse to take such stories seriously.

7.3.2.3. Simulation Calculations

The following are the results of a series of simulation calculations for the determination of the relative saturation of the masonry with hydrogen cyanide based on the assumption that similar concentrations of hydrogen cyanide are used in all cases. In so doing, a distinction is made between two sets of circumstances:

1. Disinfestation chamber. The constant concentration assumed for the calculation amounts to 10 g/m³. A constant concentration cannot, however, be assumed, particularly for the existing epidemic disinfestation installations BW 5a und 5b existing in Birkenau, since great quantities of hydrogen cyanide would escape through the non-airtight roof on the one hand, and since both the masonry and the clothing would have absorbed considerable quantities of hydrogen cyanide over time (see chapter 7.3.1.3.3.). We therefore assume two models, as follows: a) one gassing daily with a constant concentration over 6 hours, and b) one gassing daily with 12 hours of constant concentration.⁴⁹⁶ This would

⁴⁹⁶ In order to keep the HCN concentration in those make-shift delousing chambers of BW 5a and BW 5b constant over 12 hours, this would have required the application of an initial concentration at least twice or thrice as high as 10 g/m³, but this would have been impossible due to lack of sufficient Zyklon B. The quantities of Zyklon B necessary for such use would have corresponded to 24 to 30 kg per day, or approximately 9 to 11 tons per year, which is roughly the total quantity delivered to the camp, leaving no HCN for homicidal gassings. Hence, this scenario is unrealistic for our purposes, because our scenario requires homicidal gassings; see also chapter 7.3.1.3.

mean that the chamber was used around the clock, *i.e.*, more or less 24 hours a day, seven days a week, which must be viewed as the extreme upper value.

2. Homicidal “gas chamber.” Here as well, our calculation assumes a constant concentration of 10 g/m³. I have selected two different gassing times here: 1/20 day (72 min) and 1/100 of a day (14.4 min). The first value corresponds to the average constant exposure time of “gas chamber” walls to HCN if assuming no Zyklon B introduction columns and a fairly good ventilation after the gassing (see 5th column in Table 11), the second value corresponds to the same scenario, but this time with Zyklon B columns and a close to perfect ventilation after the gassing (see 5th column in Table 12).

In former editions of this expert report, I have used the equations determined in chapter 6.7.4. to calculate the relative saturation of masonry cyclically exposed to hydrogen cyanide. However, after using several approaches on exactly how to do it, which lead to sometimes quite different results,⁴⁹⁷ I decided to refer to this equation only in order to establish the time it takes for masonry to reach its maximum saturation or a quasi-constant concentration (20 days and 20 daily cycles, respectively). In this edition, the quasi-stationary concentrations in masonry were calculated iteratively using Fick’s law of diffusion.⁴⁹⁸

One wall model used was considered to be insulated at one end that corresponds to the situation as given in morgues 1 of Crematoria II and III, which were built of two layers of brick wall with a insulating layer of tar in between.⁴⁹⁹ The other wall model had no such insulation, *i.e.*, it lost HCN on its “outside,” leading to an average concentration within the entire wall which is roughly half as high as in the insulated case. This was the situation as it was given in the Zyklon B disinfection rooms of BW 5a and BW 5b.

Table 13 shows the results of these calculations. Whereas the average concentration profile of the insulated wall model is constant, it is linearly decreasing in the non-insulated walls from the inside out. The maximum average values close to the inner, HCN-exposed surface are

⁴⁹⁷ The equations determined in chapter 6.7.4. consist of two terms, which can be handled individually or both together, and it is not at all clear which time value is to be used when switching over from gassing to airing, which all influences the result.

⁴⁹⁸ I am not going to explain basic statistical laws of diffusion here. This law is so commonly known that anybody interested in it might look it up in any physics book. Maybe the iterative steps I used were a bit too big, so there is an error margin in my calculations, but if so, it affects all series, so it should not make a difference regarding my comparisons.

⁴⁹⁹ See chapter 5.4.1.1. and footnote 189. Though tar is not gas-tight, it still prevents most of the water and HCN to penetrate it.

Table 13: Quasi-stationary concentrations of HCN in masonry in percent of saturation, as a function of daily exposure time to HCN

time	insulated	not insulated, average	not insulated, on surface
14.4 min	1.6%	0.8%	1.6%
72 min	7.9%	4.2%	7.8%
6 h	30.9%	16.2%	30.6%
12 h	56.1%	29.8%	56.2%

quite comparable to the respective constant average concentrations in the insulated cases.

I have emphasized the values of particular interest: In case of homicidal gassings in the morgues 1 of Crematoria II and III (without Zyklon B introduction columns), the walls will reach a quasi-stationary concentration of 8% of their saturation concentration. In case of disinfection chambers, the value given for 6 hours of exposure to a constant HCN concentration – corresponding to a round-the-clock operation – leads to ca. 16% for the average value of the entire wall, and some 30% for the surface.

The values under consideration here are percent values of the saturation concentration of a wall, *i.e.*, *relative* values. The cases of the disinfection and homicidal “gas chamber” are only correctly comparable when one considers the *absolute* hydrogen cyanide concentrations in the masonry. If, for example, one considers that, in particular, the interior walls of the disinfection chambers intended for personal effects were warm, dry walls, while the alleged homicidal “gas chambers” in Crematoria II and III were cool and very moist, then, with equal gassing concentrations, one must multiply the relative concentrations of the homicidal “gas chamber” by the factor of the increased hydrogen cyanide absorption capability of cool, moist walls. If one assumes the value of 8 determined in this regard on page 175, then the absolute average hydrogen cyanide content of the homicidal “gas chamber” would be a value lying around 64% of the saturation concentration of a warm, dry wall in a disinfection chamber, *i.e.*, four times higher than the average hydrogen cyanide content of the disinfection chamber wall (ca. 16%), and more than twice as high as its maximum content at the surface (ca. 30%). Even when assuming the existence of Zyklon B introduction columns and a close to perfect success of the subsequent ventilation, the moist and cool homicidal “gas chamber” walls would still have accumulated HCN corresponding to 13% of the average saturation of dry

disinfestation walls, which is close to what would accumulate in those disinfestation walls (16%).

As a result of the high moisture content of those underground morgues, one can see that even with such short gassing times, the walls of a homicidal “gas chamber” accumulate a hydrogen cyanide content which would be quite comparable to that of a disinfestation chamber. Much less hydrogen cyanide in the quasi-stationary condition of the hypothetical homicidal “gas chambers” could only be expected, if one were to assume absurdly short, but technically unfeasible gassing times, the application of very little Zyklon B, or only very few gassings at all.⁵⁰⁰

7.3.2.4. Excursus: Capacity of Protective Filters

Filter devices to protect against hazardous and/or lethal gases and vapors are divided a) into types according to the kind of gas to be filtered and b) into classes according to their capacity. Filters of class 3 with a large capacity are stored externally, usually in a container to be carried at one’s side, since they are too heavy to be carried on the mask. They are connected to the mask with a hose. Filters of class 2 are screwed into the mask and form the majority of all used filter types. Filters of class 1 are plug-in filters.

The service life of gas filters depends on:

- Type and concentration of the harmful compound;
- Air demand of the carrier, as a function of the intensity of work performed and the personal constitution;
- Humidity and temperature of the air.
- Needless to say that the Deutsche Institut für Normung (DIN, German Institute for Standardization) has determined the mini-

Table 14: Maximally admissible concentration of harmful compound for protection filters⁵⁰¹

Gas filter class	Maximally admissible concentration of harmful compound	
1	0.1 vol.%;	1,000 ml m ⁻³ (ppm)
2	0.5 vol.%;	5,000 ml m ⁻³ (ppm)
3	1.0 vol.%;	10,000 ml m ⁻³ (ppm)
Short-term excess up to twice of the table value is permissible		

⁵⁰⁰ These calculation were made without considering the effect of an elevated CO₂ content in the alleged “gas chambers,” the exact effect of which is not known. Hence, there is plenty of room for future research.

⁵⁰¹ Hauptverband der gewerblichen Berufsgenossenschaften, *Atenschutz-Merkblatt*, Carl Heymanns Verlag, Cologne Oct. 1981.

Table 15: Minimum break through times for filters according to DIN 3181 part 1 in minutes⁵⁰²

type	test gas	break through criterion (ppm)	class 1 test concentration	class 2 test concentration	class 3 test concentration
A	CCl ₄	10	80	40	60
B	Cl ₂	1	20	20	30
	H ₂ S	10	40	40	60
	HCN	10*	25	25	35
E	SO ₂	5	20	20	30
K	NH ₃	25	50	40	60

* relating to HCN + (CN)₂

imum values of break-through times of filters under standard testing conditions. These conditions are:

- 20°C;
- 70 % relative humidity of air;
- 30 liters flow-through of air per minute.

In Table 15 the values of different filter types are given with their respective harmful gas.

Hydrogen cyanide filters used by the Allies during that time belonged to class 3 with filters to be carried externally. The service life of such filters at hard physical labor and 0.05 vol.% of hydrogen cyanide is given as 3 to 5 hours. At a concentration of over 1 vol.%, the gas quickly breaks through even these devices.⁵⁰³

R. Queisner wrote a report about his experiences with German filter devices used during the Second World War for delousing procedures with hydrogen cyanide.⁵⁰⁴ The filter inserts “J” and “G” used at that time were especially developed for being applied in air containing hydrogen cyanide and had a service life of 30 min. with a peak load of 1 vol.%. Since the mask carrier is only exposed to small amounts of hydrogen cyanide during delousing activities (during distribution of the product and at the end of the gassing, the hydrogen cyanide concentration is rather low), experience showed that it is possible to use the mask for several hours.

⁵⁰² DIN 3181 part 1, draft, *Atemfilter für Atemschutzgeräte. Gas- und Kombinationsfilter der Gasfilter-Typen A,B,E und K. Sicherheitstechnische Anforderungen, Prüfung, Kennzeichnung*, Beuth Verlag GmbH, Berlin, May 1987.

⁵⁰³ War Department, *Hydrocyanic-Acid-Gas Mask*, U.S. Government Printing Office, Washington 1932; War Department, *Technical Manual No. 3-205*, U.S. Government Printing Office, Washington 1941.

⁵⁰⁴ R. Queisner, “Erfahrungen mit Filtereinsätzen und Gasmasken für hochgiftige Gase zur Schädlingsbekämpfung,” *Zeitschrift für hygienische Zoologie und Schädlingsbekämpfung*, 1943, pp. 190-194.

According to Schmidt,⁴⁴¹ relaxed humans inhale some 14 liters of air per minute. This can increase up to 50 to 60 liters per minute in case of heavy physical work, in extreme cases even up to 100 to 120 liters.

If, according to Pressac and in agreement with the witness accounts, a concentration of 1 vol.% was used during the gassings, the inmates of the special commands (*Sonderkommandos*), who carried away the corpses out of the “gas chambers” of the Crematorium IV and V as well as out of the farmhouses I/II, which did not have a ventilation system, had to wear gas masks. Equipped with gas filters of class 2 and doing heavy physical work, they would have been exposed to a high concentration of toxic gas. Since hydrogen cyanide is particularly well absorbed through sweat-wet skin, this would certainly have led to signs of poisoning.

The minimum break-through times of corresponding modern gas filters of class 2, type B (for hydrogen cyanide) lies at 25 min. for 0.5 vol.% at an air flow-through of 30 liters per min. In case of sufficiently hard physical labor, this time will be quickly cut to half or a quarter. Therefore, a modern filter of class 2 can offer only several minutes of safety under the circumstances under consideration. Breathing would have been seriously hindered by these filters (max. 5.6 mbar pressure difference at 95 liters per min. according to the current DIN), hence the working speed would have been slow and the demand for resting times and forced pauses due to gas poisonings would have been huge. Since they were especially designed for hydrogen cyanide, the filters of that time had a higher capacity, and consequently their durability might have been correspondingly higher, which, in turn, increased their service time.

Pressac writes⁵⁰⁵ that a hydrogen cyanide concentration of 1 vol.% is not tolerable even with filter mask, and that an exposure time of up to one minute is granted only in emergency cases, and this without any heavy physical work!

Finally, a poisoning through the sweat-wet skin would have been avoidable under these circumstances only if the workers would have worked with protective garments in the “gas chamber,” which was not reported by any witness and which would have reduced the working performance even more. The accounts of some witnesses regarding the applied concentrations *and* the quick clearing of the chamber after the execution *without* protective garments and masks, on which even Pressac relies, exclude each other and thus can certainly not be correct.

⁵⁰⁵ J.-C. Pressac, *op. cit.*, (note 72), p. 16.

It should not be forgotten here that hydrogen cyanide is a contact poison. Transporting corpses, on whose skin huge, possibly lethal amounts of hydrogen cyanide are absorbed, had required that the special commands dealing with these corpses had to wear protective clothes. Finally, when considering the applied concentrations attested to, the guards, like the special commands, would have risked their health. This is true for all “gas chambers.”

7.3.3. Evaluation of Eyewitnesses

It is possible to provide a satisfactory answer to the problem of the Zyklon B introduction holes in the roofs of Morgue 1 (the “gas chambers”) of Crematoria II and III through the interpretation of air photos and structural considerations. One must therefore conclude that the holes and cracks visible today were only put in during or after the destruction of the building during the winter of 1944-45. This means that the poison gas could not have been introduced into the alleged “gas chambers” in the manner described by the eyewitnesses.

The rapidity of the executions as described by the eyewitnesses, in their extreme values (“a few moments,” “a few minutes,” “two minutes,” etc.) cannot, once again, be attained with Zyklon B under the given technical conditions, and can only be attained through the use of very high quantities of Zyklon B.

Entering the “gas chambers” without protective measures, the performance of heavy physical work in the chambers, sometimes with a naked torso, while eating and smoking, along with testimony relating to large quantities of toxic gas, reveals the perjury of these eyewitnesses.⁵⁰⁶

Equally false are the statements relating to the duration of ventilation of Morgue 1 (the “gas chamber”) of Crematoria II and III, since the ventilation would be greatly influenced by various factors (hindrance of circulation by the bodies, the short circuit in the ventilation pathway, the release of hydrogen cyanide by Zyklon B). In fact, safe entry into the “gas chamber” without protective measures can hardly have been possible in less than three to four hours. Finally, heavy physical work could only have been conceivable before the expiration of at least another one and a half hours, even with gas masks.

The eyewitness testimonies relating to the alleged cremation of the bodies, finally, are riddled with fantasy: cremation in deep ditches;

⁵⁰⁶ There are, of course, witnesses who allege that gas masks were worn, e.g., C. Vaillant-Couturier, in: *IMT*, vol. VI, p. 216. Protective garments, however, are never mentioned.

cremation with liquid fuels; entirely without – or with ridiculously little – fuel; the destruction of corpses with explosives; the collection of human fat. These have nothing in common with technical reality or possibility, and are largely refuted by the Allied aerial photographic evidence: no huge ditches, no smoke, no fire, no fuel storage areas.

The illogical and ridiculous – in Pressac’s words – gassing scenarios in the “gas chambers” of Crematoria IV and V as well as the comparable ones in farmhouses I and II, would have been extremely dangerous for the *Sonderkommandos* (see chapter 5.4.2. and 5.4.3.). Yet these “gas chambers” must have been planned and built as instruments of mass murder,⁵⁰⁷ if mass gassings were already underway elsewhere in the camp during their period of construction. All of this must compel people accustomed to thinking in terms of technology and the natural sciences to conclude that the Germans must have decided to choose absolutely the most expensive, laborious, most dangerous and difficult way possible in which to kill people *en masse*.

It would have been logical, for propaganda purposes, to have described the installations such as the disinfestation chambers intended for personal effects located in buildings 5a and 5b as homicidal “gas chambers.” But this was never attempted, nor are there any eyewitness testimonies as to such a utilization of these premises. Furthermore, the doors drawn in the plans of the disinfestation chambers of buildings 5b – as well as the doors located there today – open inwards, which would have rendered it impossible to remove bodies lying in front of the doors after the mass gassings. These rooms were, therefore, certainly never used as homicidal “gas chambers.” It is nevertheless possible that an attempt was made to represent the disinfestation chamber in building 5b as a (fake) homicidal “gas chamber.” The water pipes visible there hang freely in space inside the room, without any connection; only a few of them are equipped with shower heads, while they terminate in the ventilation openings in the exterior wall, *i.e.*, they were installed after the removal of the disinfestation devices (ovens, ventilators, and so on), very probably after the German withdrawal (see Fig. 21). Remarkably, all pipes and fittings have been removed from the real shower room in the same wing (see Fig. 18). In case this is not an attempted falsification, it is still possible that this wing was clumsily converted into a shower room after the end of the war, when Birkenau was used as prisoner camp for Germans. But this is not likely, since this building had

⁵⁰⁷ J.-C. Pressac, *op. cit.* (note 72), p. 447

proper showers already, so why dismantle them first, and then construct a makeshift shower in a room unsuitable for it?

Brief mention should be made at this point of the widespread notion that the toxic gas streamed into the alleged homicidal “gas chamber” through shower heads, especially as there are even a few such eyewitness statements. Zyklon B consists of the active ingredient, hydrogen cyanide, adsorbed on a solid carrier material (gypsum) and only released gradually. Since it was neither a liquid nor a gas under pressure, the hydrogen cyanide from this product could never have traveled through narrow water pipes and shower heads. Possible showers, or fake shower heads, could therefore only have been used to deceive the victims; they could never have been used for the introduction of this poison gas. There is general unanimity as to this point, no matter what else might be in dispute.

Table 16: Evaluation of eyewitnesses

EYEWITNESS CLAIM	EVALUATION
Death of all victims after 0 (instantaneously) to 15 minutes.	If high concentrations of hydrogen cyanide are used, as in American execution chambers, death occurs in a period of 10 minutes or even later. During the process, the victim is therefore exposed to a high overdose concentration of hydrogen cyanide. Technically this is not possible with Zyklon B, since the Zyklon B carrier base releases the gas slowly (50% in 30 to 90 minutes, according to the temperature and relative humidity). The distribution of the gas throughout the chamber from a few sources of hydrogen cyanide only, and the absorption of the gas by the moist walls and the nearby victims would further delay the process. Killing all the victims in a few (less than five) minutes would be impossible, even when using very large quantities of Zyklon B (much more than 10g per m ³).
Opening of the doors to the “gas chamber” after the execution (and sometimes a short ventilation time) and immediate commencement of transport of the bodies without gas masks and protective clothing.	The ventilation system, if it existed, did not have the performance to clear the chambers in the time frame attested to. Assuming that the victims died quickly from the high concentrations of toxic gas, then the workers in the <i>Sonderkommando</i> would also have been killed by the gas. Working without gas masks equipped with a filter is totally inconceivable; at high concentrations of poison gas, even these are very unsafe. Heavy respiratory devices must be worn at concentrations of over 0.5 vol.%, which would render the removal of the bodies much more difficult. Contamination through the skin must be expected during heavy work, involving perspiration, and due to the high concentrations of hydrogen cyanide on the skin of the victims. At the same time, such concentrations are sufficient to put a stop to the workers’ ability to work (dizziness, nausea, etc.). Protective clothing is therefore required.
Blue vapor over the victims.	Hydrogen cyanide is a colorless liquid and/or an invisible gas. The name “ <i>Blausäure</i> ” (blue acid) is due to the reaction of hydrogen cyanide with iron, forming the iron-blue pigment. There cannot, therefore, have been any blue vapor.
Bluish/greenish coloration of the skin of the victims.	Hydrogen cyanide blocks the oxygen supply to the cells. The blood can no longer give off oxygen to the cells. Saturation of the blood with oxygen therefore occurs; the skin of the victim therefore has a reddish, not bluish, appearance, especially on the mucous membranes and during post-mortem lividity. On the other hand, if the victims had slowly suffocated, this could explain bluish coloration of skin.
Attempted destruction of the bodies by means of explosives.	Totally unsuited and dangerous.
Cremation of bodies in crematorium ovens without fuel.	This testimony is quite absurd. Cadavers never burn due to their own fat content alone. Additional fuel is always required.

EYEWITNESS CLAIM	EVALUATION
Commencement of body transport from the chamber of Crematoria II and III 20 minutes after commencement of ventilation, without gas masks.	The unheated morgues 1 of Crematoria II and III, filled with bodies, would have been incompletely ventilated in 20 minutes using the allegedly built-in ventilation installation. Hydrogen cyanide released for hours from the Zyklon B distributed among the bodies, release of hydrogen cyanide absorbed by the skin and walls and the absence of air exchanges between the bodies would have led to ventilation times amounting to several hours, before the cellar could have been entered without gas masks equipped with filters.
Cremation of the corpses in pits 1.5 to 3 meters deep.	Due to the high water table in Birkenau in 1942-1994, deep pits would have quickly filled with water. The maintenance of fires in such pits was not possible.
Cremation of the corpses with methanol and/or old oil.	The complete cremation of corpses requires a high temperature. Liquid fuels always burn only near and on the corpse, so that the heat is lost upwards; in addition, they trickle down into the subsoil in open air. Methanol evaporates very easily and therefore has a very low flame temperature. Experiments with cremations in the open air show that corpses can be carbonized on the outside, but not, however, entirely cremated with these fuels.
Pouring escaping human fat over the bodies.	This is an entirely absurd testimony. If anything burns in the flesh at all, it is the fat. Since the bodies would have been lying in the fire, the fat cannot possibly have been collected outside the fire by means of channels.
Flames shooting out of heavily smoking crematorium chimneys.	Coke fires are very short-flamed and develop only little smoke, and this smoke usually burns within the muffle. Even carbonized, burning corpses do not generate any flame and smoke only slightly if the muffle is working inefficiently. That flames could penetrate through a 10 meter long flue and a 15 ft high chimney to the outside, is technically impossible. Even the fire's reflections disappear in the flue.

7.3.4. An Expert on Cyanide Speaks Out

Gérard Roubeix
51 Av. de la Coquetterie
44000 Nantes

Nantes, the 2nd Nov. 1997
to M. Michel Adam
c/o ANEC
PO Box 21
44530 St. Gildas-des-Bois

Sir,

Having learned about the odious persecution of which you are a victim in the name of “freedom of expression,” let me express all of my sympathy and my total solidarity to you.

I have spent 20 years of my career as an engineer in the hydrogen cyanide industry in the service of the groups Pechiney-Ugine-Kuhlmann and Charbonnages de France. In particular, I have been the director of the St. Avold plant, which in 1970, with its production of 40 tons of cyanides per day, was the most important plant worldwide; theoretically, this production would have allowed the lethal poisoning of 500 million human beings on a single day. This shows how I am aware of the problems regarding the handling of HCN. Well, I affirm that all the “testimonies” I have read or heard of concerning these gas chambers, in which 2 to 3,000 people were crammed, are nothing but total fantasy.

I congratulate you for your admirable battle against the hoax. The truth is on its way.

[signed Roubeix]

P.S: You may use this testimony, if necessary.”

Michel Adam was a teacher of history and geography in the west of France. At the beginning of July 1997, as a former lady deportee to the concentration camp of Ravensbrück was giving a conference at his school telling about her “memories,” he opposed the lady several times by using solid revisionist arguments. Michel Adam was immediately suspended and, after one year of troubles of all sorts, he was dismissed by French Minister for the Arts Claude Allègre on account of the three following official reasons:

- showing his revisionist views in front of his pupils;

- disturbing a meeting of his pupils with a former deportee;
- showing doubts about the credibility of a deportee's testimony.

Already in 1988 Gérard Roubeix wrote a similar letter which has been published elsewhere.⁵⁰⁸ He died in 2001.

ANEC stands for *Association normande pour l'éveil du citoyen*, (Norman Association for the Warning of Citizens), which was an association created by the Normandy teacher Vincent Reynouard, who, just as Michel Adams before him, lost his job because of his revisionist views and was sentenced to fines and various prison terms.⁵⁰⁹ *ANEC* published 36 issues of the revisionist periodical *Nouvelle Vision*.

⁵⁰⁸ *Annales d'Histoire Révisionniste* 7 (1989), pp. 212f.

⁵⁰⁹ Cf. Vincent Reynouard, "Deutsch-Französische Völker-Freundschaft," *VffG*, 4(3&4) (2000), pp. 410-415.

GÉRARD ROUBEIX

Ingénieur des Arts et Manufactures

51 Av. de la Coquetterie
44 600 NantesNantes le 2 Nov 97
à M^r Michel Adlam (87)
% ANEC
BP 21
44530 ST Gildas. des. Poo

Monsieur,

Ayant appris l'odieuse persécution dont vous êtes la victime au nom de la "liberté d'expression" je tiens à vous témoigner toute ma sympathie et ma totale solidarité.

J'ai passé 20 ans de ma carrière d'ingénieur dans l'industrie de l'acide cyanure de potassium au sein des groupes Technip - Uzin - Kuhlmann et Charbonnages de France. J'ai été notamment directeur de l'usine de St-Amand qui, avec sa production de 40T par jour et ion cyanure était en 1970 la plus importante du monde; cette production aurait permis théoriquement d'intoxiquer mortellement 500 millions d'êtres humains en une seule journée. C'est dire que je connais les problèmes concernant la manipulation de l'HCN. Et bien j'affirme que tous les "déshonneurés" que j'ai lus ou entendus concernant ces chambres à gaz dans lesquelles on enfouissait 2 à 3000 personnes relèvent de la plus totale fantaisie.

Je vous félicite pour votre admirable combat et l'importance de la vérité est en marche

si nécessaire utilisez ce té-

7.3.5. Why, Precisely, Zyklon B?

One might naturally wonder why the SS are supposed to have decided to use Zyklon B as an instrument of mass murder. The Soviets, at any rate, killed countless millions of human beings either simply by shooting them in the back of the neck or allowing them to die in camps under miserable conditions. Surely it would have been simpler to leave the people deported to Auschwitz to their fate; they would have perished from hunger and epidemics within a very short time anyway. That is how the Americans murdered approximately 1 million German civilian internees after the end of the Second World War.⁵¹⁰ Instead, the SS at Auschwitz spent almost one billion dollars, in today's values, to bring the epidemics raging there under control, incurring huge expenditures on medical facilities, to cure the internees from the typhus epidemics, which were very often fatal.⁵¹¹ This alone speaks volumes about the credibility of the conventional wisdom.

The academic question, therefore, of whether or not some other poison gas would have been better suited for the mass murders instead of hydrogen cyanide in the form of Zyklon B cannot, in the last analysis, be answered, since there are no scientifically documented experimental values for mass murder by poison gas.

Theoretically, one could, at that time, have chosen between nitrogen (N₂), carbon dioxide (CO₂), carbon monoxide (CO), phosgene (COCl₂), chlorine (Cl₂), hydrogen cyanide (HCN), nerve gases such as Tabun and Sarin, Diesel engine exhaust, internal combustion engine exhaust, producer gas, coke or city gas, process gas, and, possibly, still other, entirely different, instruments of mass murder, suitable even under completely different circumstances (shooting in the back of the neck, hunger, epidemics). But if one really wished to take the trouble to commit mass killings with poison gas, it is most probable that one would have used carbon monoxide, which is definitely lethal to human beings above 0.1%, for the following reasons:

⁵¹⁰ James Bacques, *Other Losses*, Stoddart, Toronto 1989; Bacque, *Crimes and Mercies*, Little, Brown & Co., Toronto 1996.

⁵¹¹ Hans Jürgen Nowak, *op. cit.* (note 102), pp. 323f.; Manfred Gerner, Michael Gärtner, Hans Jürgen Nowak, "Die Kosten von Auschwitz," *VffG*, 6(2) (2002), pp. 146-158; on the medical care, see the unpublished studies by the late C. Jordan on the G. Weise case; see also *idem*, "The German Justice System: A Case Study," in G. Rudolf (ed.), *op. cit.* (note 24), pp. 145-179.

1. The poison gas CO was available in limitless quantities and in lethal concentrations at giveaway prices, substantially cheaper than Zyklon B, on almost every street corner in the Third Reich:
 - a. Internal combustion engines easily attain a CO content of 7% by volume, so that they would have been suitable for mass murder. Nevertheless only a very small minority of eyewitnesses speak of the use of internal combustion engines in only one German concentration camp (Sobibor).⁵¹²
 - b. Producer gas generators generate a gaseous mixture with a proportion of CO of up to 35% by volume, using only wood or coke, air and water. These generators were installed in hundreds of thousands of vehicles all over German-occupied Europe during the Second World War, since it was necessary to convert to alternative fuels due to the Allied oil blockade. As F.P. Berg has shown, every member of the German Reich Government was familiar with these extraordinarily economical and easily operated installations with their quickly lethal toxic gas, especially the transport experts, whose duty it was to gradually replace all Diesel and gasoline engines with generator gas installations. These were, in some cases, exactly the same people who were entrusted with the deportation and allegedly with the killing of Jews – such as Adolf Eichmann, for example.⁵¹² But it has never been claimed that these installations were used for purposes of homicide.
 - c. Toxic city gas with a CO proportion of up to 30% by volume was available in every major city for a ridiculously low price. Consideration would obviously have been given to committing murder with it, had there been any extermination plan.
 - d. Process gas: The German corporate giant *I.G. Farbenindustrie AG* had already built a coal gasification/liquefaction plant only a few kilometers away from Auschwitz concentration camp in the early 1940s. Here, by means of various conversion processes, coal was converted into chemical end products, from which oils, fats, fuels, and synthetic rubbers could be made. The first step in this procedure is the generation of process gas, which has a similar composition to coke gas or city gas. The *I.G. Farbenindustrie AG* factory had a concentration camp in its immediate vicinity by the name of Monowitz, which was connected to the extensive system of more than 30 different so-called satellite camps of the Auschwitz main camp in Upper Silesia and Western Poland. If the SS had looked

⁵¹² See Friedrich P. Berg, “The Diesel Gas Chambers: Ideal for Torture – Absurd for Murder,” in: G. Rudolf (ed.), *op. cit.* (note 24), pp. 435-469.

for a simpler way to kill millions of Jews, the center of extermination certainly would have been built in the vicinity of Monowitz, with a direct process gas pipeline from the *I.G. Farbenindustrie AG* factory.⁵¹³

2. It would not have been necessary to order and store CO and pay attention to the use-by date, as was necessary in the case of Zyklon B; carbon monoxide would have been available at all times, as soon as the economical installations were completed.
3. The handling of CO would have been considerably simpler for the executioners. Almost the only thing to pay attention to would have been the opening and closing of the CO valve. The handling of Zyklon B, on the other hand, would have demanded a remarkable number of safety precautions on the part of the executioners. The wearing of gas masks, and, when possible, additional protective clothing (gloves), the careful opening of the cans with a suitable tool, the careful introduction of the carrier through the openings, the careful disposal of the Zyklon B residues.
4. CO can be introduced simply and quickly through pressure pipes or through a blower, while Zyklon B, on the other hand, releases its toxic fumes only slowly.
5. In the case of CO, there would not have been so many problems with ventilating the air in the mass execution areas as with hydrogen cyanide/Zyklon B, since the introduction of CO could be stopped simply by closing a valve, and because CO does not adhere to surfaces and is almost insoluble in water – in extreme contrast to hydrogen cyanide.
6. Since CO does not affect insects,⁵¹⁴ it could not be used to combat lice and other carriers of disease. Zyklon B was therefore desperately needed for this purpose, but it was scarce and expensive, because it was used to combat epidemics not only by the SS, but also by German civilian companies, by civilian government agencies, by the German army as well as by German-allied armed forces. Hence any evitable squandering of it for other purposes would have been avoided – even, and especially, at Auschwitz, where typhus threatened not only the lives of the inmates, but also the guards and civilians entering the camp or who lived in the vicinity. In plain English, this means that the typhus epidemic in Auschwitz concentration camp threatened the extremely important production of the war in-

⁵¹³ Curiously enough, Dr. Konrad Morgen, an SS judge who investigated criminal activities of SS personnel in various camps, claimed after the war during the *IMT* that exterminations at Auschwitz had been carried out at the Monowitz camp close to the I.G. Farben plant – in stark contrast to all other witnesses; *IMT*, vol. 20, 499, 503f.

⁵¹⁴ Most insects do not have haemoglobin, the blood pigment which transports oxygen in mammals, but which is blocked by CO; see Geraldine M. Baker, E. A. Wright, "Effects of carbon monoxide on insects," *Bulletin of Environmental Contamination and Toxicology*, 17(1) (1977), pp. 98-104; www.springerlink.com/content/u25073273n631311/

dustries located in Upper Silesia, the second-greatest industrial region in Germany after the Ruhr at that time. The struggle against epidemics, for which Zyklon B was undoubtedly needed, was therefore of the greatest importance, in larger quantities than the manufacturer, Degesch, was able to deliver at that time.

Naturally, CO would not necessarily speed up the execution procedure in comparison to hydrogen cyanide, but it would have been safer, more easily available nearby, less complicated, and cheaper.⁵¹⁵

Certainly,

“the bottleneck in the extermination process [...would have been] the incineration of the bodies, not the gassing itself. [An appropriate equipment provided,] A thousand people could be killed in a matter of minutes, or an hour or two at most, counting the entire operation from arrival at the camp to the final ventilation of the gas chamber.

*Yet to burn the bodies of those thousand people [...would have taken] quite a long while.”*⁵¹⁶

As C. Mattogno has shown,⁴⁶¹ the cremation installations at Auschwitz were never able to cremate the bodies of the dead from the various epidemics and other unhygienic conditions of Auschwitz camp which occurred anyway, not to mention the bodies allegedly occurring as the result of mass murders. This is a further proof that there was never a program of mass homicide at Auschwitz.

⁵¹⁵ If for no other reason because, according to the establishment literature, CO was also already used in connection with the euthanasia action.

⁵¹⁶ According to a part of the answer from “Nizkor” (www2.ca.nizkor.org/features/qar/qar29.html) to question no. 29: “Why did they use this instead of a gas more suitable for mass extermination?” (www.zundelsite.org/english/debate/debatetoc.html) of a flyer distributed by the Institute for Historical Review: *66 Questions and Answers on the Holocaust*, IHR, Costa Mesa, undated.

8. Evaluation of Chemical Analyses

8.1. Test Sample Taking and Description

As far as I am aware, test samples from buildings at Auschwitz have been analyzed by four persons or groups so far.⁵¹⁷

1. Fred A. Leuchter, Consulting Engineers, Boston, MA, on behalf of the defense of E. Zündel, Toronto. F.A. Leuchter marked the locations where he took samples from crematoria in maps of these buildings drawn by himself and reproduced in his expert report. Only Leuchter's samples taken from Morgue 1 ("gas chamber") of Crematorium II are reproduced in the sketch below (Fig. 67). J.-C. Pressac has subjected the sample taking to criticism.⁴⁹ Leuchter failed to indicate a more exact specification of the sample material; the designation is "brick" in all cases. The sample taking was done without regard for depth. From the traces left by Leuchter in the corresponding places in the masonry, one must calculate sample taking depths of up to 3 cm and more.

2. Prof. Dr. Jan Markiewicz, Jan Sehn Institute for Forensic Research, Toxicology Department, Krakow, on behalf of the Auschwitz State Museum. J. Markiewicz provides more exact data on the sample taking locations, the type of material, and the depth taken in a sample taking records for the samples he took in 1990. The control samples were taken from a disinfestation chamber in the Auschwitz main camp, the interior walls of which, according to the report, were painted during the war, so that only a pale blue tint is visible in places. This is not, therefore, unaltered masonry material; thus, in case the samples were taken from the upper layer of the wall only, one has to expect lower results in comparison to an untreated wall.⁶¹ In 1994 Markiewicz et al. did a second series of analysis of more than 60 samples taken from various buildings at Auschwitz and Birkenau, plus they performed a series of experimental gassings. The descriptions of sampling locations, material type and depth are scanty at best.⁶²

3. Dipl.-Chem. Germar Rudolf, Stuttgart, Germany, on behalf of the defense of the late Major General O. E. Remer. The samples were taken in the presence of witnesses by hammer and chisel and immediately sealed in plastic bags. The subsequent numbering of the bags was recorded by hand, including the measured sample taking location and type

⁵¹⁷ C. Mattogno (Rome) has also taken samples from some of the installations ("gas chambers") at Birkenau and has had them analyzed; the findings concur with those of F.A. Leuchter and G. Rudolf. C. Mattogno, letter to the author, Rome, May 26, 1992.

of sample. Table 20 shows buildings, sample taking locations and depths, as well as a brief description of the wall material. The exact locations are shown in the sketch of the corresponding buildings in chapter 5 of this book.

4. John C. Ball, Ball Resource Services Ltd., Delta, BC, Canada. John C. Ball has not given any details about where exactly he took his samples, nor what kind of material it was. According to his own description, at least the samples from the delousing rooms of BW 5a and BW 5b consist of a mixture of material taken at various places of these rooms, both inside and outside. Hence, the same might be true for his other samples. For this reason, we will only briefly list Ball's analysis results here without going into too many details about how they are to be interpreted.

8.2. Analytical Methods

The analyses were performed in each case respectively by:

1. Prof. Dr. J. Roth, Alpha Analytic Laboratories, Ashland, Massachusetts. For the cyanide analysis, this laboratory used a procedure carried out analogously to the German standard (see 3.).⁵¹⁸ Control analyses were prepared for some test samples near the detectable threshold of 1 mg cyanide per kg test material. The results fluctuated up to 40%.

2. Jan Sehn Institute for Forensic Research, Toxicology Department, Krakow, Poland, under Jan Markiewicz. The Polish scientist used the micro-diffusion chamber procedure, which does not permit the detection of Iron Blue.⁵¹⁹ The Poles claim that the detection threshold for other cyanides lies at 3-4 µg per kg sample material, yet the paper they cite clearly gives 0.2 mg/l (200 µg/kg) as a threshold for aqueous solutions.

3. Fresenius Institute, Taunusstein, Hessen, Germany, with no knowledge of the origins of the samples. Proof of the presence of cyanide was produced in conformity with DIN 38 405, section D 13. The detection threshold lies nominally in the range from 0.5 to 0.1 mg per kg.⁵²⁰

⁵¹⁸ The iron content was also determined by means of ICP spectrometer. The values lay between 6 and 7.5 g per kg.

⁵¹⁹ Joseph Epstein, "Estimation of Micro-quantities of Cyanide," *Industrial and engineering Chemistry*, 19 (1947), 272-274; In this procedure, the sample is to semi-concentrated sulfuric acid for 24 hours. The gases released are only collected by means of diffusion in a KOH collector.

⁵²⁰ Driving out the hydrogen cyanide by boiling the sample for one hour in aqueous HCl in a slightly reductive medium (SnCl₂), Driving out in the continuous stream of air, collection in the

All values below 0.5 mg per kg are uncertain and are commonly marked as “not detected (ND).” Control analyses were performed by the *Institut für Umweltanalytik Stuttgart*, IUS (Institute for Environmental Analyt-ics) using DIN 38 405, section D 14, which differs from D 13 only by not adding cadmium salts (Table 21). According to personal communi-cation from the manager of the *Institut für Umweltanalytik Stuttgart*, the analytical method used is designed to detect cyanides in aqueous solu-tions. Since cyanides bound within solid samples are at times hard to dissolve, detection limits are expected to be considerably higher, but he did not know of any defined treshold value.

4. Unknown. However, the results indicate that the method used was similar to the one used by Leuchter/Roth and Rudolf/Fresenius.

8.3. Evaluation of Analytical Results

8.3.1. F.A. Leuchter/Alpha Analytic Laboratories

All of Leuchter’s positive findings from the alleged homicidal “gas chamber” lie in the vicinity of the “official” detection threshold (1 mg per kg) and must be expected to exhibit very high fluctuations. Control sample no. 32 is from the disinfestation wing of building 5a (which Leuchter calls “disinfestation chamber 1”). The foundations of Crema-toria IV and V are alleged to have been rebuilt from the rubble of other buildings (see chapter 5.4.2). Thus, the analyses of samples originating from these walls are nevertheless interesting, due to their positive find-ings in places.

That the analytical values of samples from areas protected from en-vironmental influences are just as low as results from exposed locations, or not detectable at all, led Leuchter to the conclusion that the environ-mental influences could not have considerably reduced the cyanide content of the exposed buildings,⁵²¹ which would be in accordance with the findings in chapter 6.6. According to Leuchter, low cyanide traces may have resulted from an isolated fumigation of the morgues for pest control, since interior disinfestations were carried out in many camp buildings at that time. The positive result (1.3 mg per kg) of sample 28, which Leuchter took from the partition of the former washroom to the dissecting room of Crematorium I, a wall which never formed part of the alleged “gas chamber” and moreover was probably newly erected

aqueous KOH collector. Finally, photometric or titrimetric testing depending on the concentra-tion in each case. Proof of iron was achieved here by the ICP spectrometer.

⁵²¹ F.A. Leuchter, press release, Boston, February 13, 1990.

during the conversion to an air raid shelter, is remarkable. This result is approximately as high as the rest of the samples, including those from the foundation walls of Crematorium IV and V, which were rebuilt after the war using unknown material. These values may be explained by either of the following reasons or a combination of them:

1. Cyanide traces of this minimal order of magnitude may be present anywhere, which is, however, improbable.
2. This air raid shelter, like all rooms in Auschwitz-Birkenau, was occasionally fumigated with Zyklon B for disinfection purposes.
3. Analytical values in this order of magnitude (near the detectable threshold) are not reproducible and therefore cannot be interpreted due to the limited efficiency of the method. They are equivalent to zero values. In view of the results to be discussed below, this reason appears the most probable.

According to Bailer, the high cyanide content of the control samples taken by Leuchter in the disinfection wing is to be attributed either to an artifact, an error in the sample taking, or an analytical error. He understands an artifact to mean that the wall of the disinfection wing was painted with blue paint, precisely, an Iron Blue paint, at an earlier time. Bailer further expresses the opinion that no Iron Blue could form in the masonry material due to the alkaline environment. In addition, the high cyanide content of 1,050 mg per kg is said to mean that the walls consist 0.1% of pigment, which in his opinion could not possibly be true.⁵²²

As shown in chapter 6.5., the environment is only alkaline in the non-carbonated masonry. It was also established that an alkaline envi-

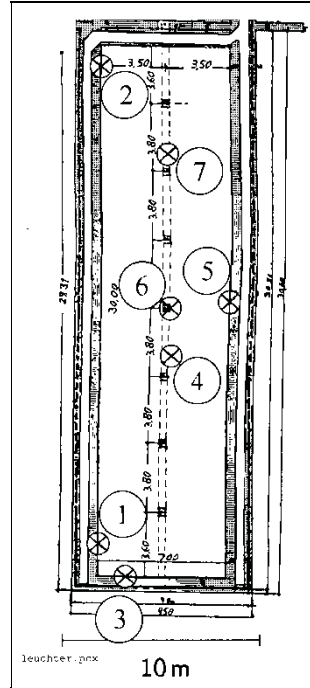

Fig. 67: Sketch of Morgue 1 ("gas chamber") of Crematorium II in Birkenau with test sample taking locations by F.A. Leuchter.³⁰

- Samples 1,2,3,5 from Masonry;
- Sample 4 from the ceiling;
- Sample 6 from the pillars;
- Sample 7 from the debris on the ground.

⁵²² J. Bailer, *op. cit.* (note 56); similar to *ibid.*, in B. Bailer-Galanda *et al.* (ed.), *op. cit.* (note 58), pp. 112-118.

ronment even supports the accumulation of cyanide and certain other steps in the reaction towards the formation of Iron Blue. If one assumes, as an extreme case, a complete conversion of all iron compounds contained in the masonry into pigment (1 to 2% iron content), the values found by Leuchter are even rather low. Whether the walls of the disinfestation wing were painted blue, *i.e.*, whether a high cyanide content can only be found on the upper, *i.e.*, the paint layer of the wall, will be discussed at a later time.

Pressac opines that the low cyanide traces in the masonry of the crematoria are the final proof of the existence of the “gas chambers,” since they are still detectable today after what was, in his opinion, a short exposure time and low reactivity of hydrogen cyanide on cool masonry and despite corrosion and erosion.⁵²³ He furthermore expresses

Table 17: Cyanide concentrations in the masonry of “gas chambers”/disinfestation chambers: Leuchter		
According to F.A. Leuchter/Alpha Analytic Laboratories, Ashland, Massachusetts, USA		
Test sample no.	Sample taking location	CN ⁻ [mg per kg]
1-7	Crematorium II, Morgue 1	0.0
8	Crematorium III, Morgue 1	1.9
9	Crematorium III, Morgue 1	6.7
10,11	Crematorium III, Morgue 1	0.0
12	Door sealing	0.0
13,14	Crematorium IV, morgue, chimney room	0.0
15	Crematorium IV, chimney room	2.3
16	Crematorium IV	1.4
17-19	Crematorium IV	0.0
20	Crematorium IV	1.4
21	Crematorium V	4.4
22	Crematorium V	1.7
23,24	Crematorium V	0.0
25	Crematorium I, morgue	3.8
26	Crematorium I, morgue	1.3
27	Crematorium I, morgue	1.4
28	Crematorium I, wash room	1.3
29	Crematorium I, morgue	7.9
30	Crematorium I, morgue	1.1
31	Crematorium I, morgue	0.0
32	Disinfestation chamber 1	1,050.0

The morgue of Crematorium I and Morgue 1 of Crematorium II are alleged to have been homicidal “gas chambers.”

⁵²³ *Op. cit.*(note 49); *ibid.*, *op. cit.* (note 72), p. 133.

the opinion that warm walls would be necessary for the formation of the pigment.⁵²⁴ Just how unrealistic this opinion really is, has already been shown: Firstly, the pigment formed is durable (chapter 6.6.); secondly, cool and moist walls have a higher reactivity to pigment formation than dry and warm walls (chapter 6.5.); thirdly, Leuchter's sample no. 28 proves that the cyanide traces are not caused by homicidal gassings.

8.3.2. Institute for Forensic Research, Krakow

The analytical values shown in Table 18 were never published by the Jan Sehn Institute. Note that in this and in the subsequent table I have added a column to the right in italics listing the cyanide concentration as it should have been rendered, since the method used warrants a reliable detection only up to 0.2 mg/kg at best. The results of Table 18 became public knowledge only due to an act of indiscretion. The results

Table 18: Cyanide concentrations in the masonry of "gas chambers"/ disinfestation chambers: Krakow I					
According to the Jan Sehn Institute for Forensic Research, Department for Toxicology, Krakow, Poland, 1990, data in mg per kg					
#	Building	Sample taking location and -depth	Material	CN ⁻	<i>CN⁻*</i>
1	Disinfestation Block 3	Room 4, around the ventilator opening, 2 mm	Plaster	0.068	<i>ND</i>
2	Disinfestation Block 3	Room 4, next to doors to Room 3, 2 mm	Plaster	0.036	<i>ND</i>
7	Disinfestation Block 3	Room 3, below window, opposite, 2 mm	Plaster	0.076	<i>ND</i>
8	Disinfestation Block 3	Door opening between Room 2 and 1, 2 mm upper left	Plaster	0.140	<i>ND</i>
9	Disinfestation Block 3	Like Nr. 8, lower left	Plaster	0.404	<i>0.4</i>
10	Disinfestation Block 3	Room 1, Ventilator opening, 2 mm	Plaster	0.528	<i>0.5</i>
11	Disinfestation Block 3	Like 10, light blue	Plaster	0.588	<i>0.6</i>
15	Crematorium II, Morgue 1	Concrete support columns	Plaster (?)	0.024	<i>ND</i>

* Values as they should have been rendered if abiding by the proven detection threshold of the method; ND = not detected; 4 additional samples from Crematorium II, 1 from Crematorium I, 1 from Crematorium V, in each case an alleged "gas chamber," and 2 control samples contained no detectable traces of CN⁻.

⁵²⁴ J.-C. Pressac, *op. cit.* (note 72), p. 53.

appear to suggest that the alleged “gas chambers” exhibit either no cyanide residues at all or values which are clearly lower than those found in samples taken from the disinfestation chambers. The scientist responsible, Prof. Markiewicz, writes about the chemistry involved:⁶¹

“Hydrogen cyanide is a weak acid, which has the result that its salts decompose slightly in the presence of stronger acids. One of these stronger acids is carbonic acid, which arises from the reaction between carbon dioxide and water. [Even] stronger acids, such as, for example, sulfuric acid, decompose cyanide even more easily. Complex compounds with cyanide

Table 19: Cyanide concentrations in the masonry of “gas chambers”/ disinfestation chambers: Krakow II

According to the Jan Sehn Institute for Forensic Research, Department for Toxicology, Krakow, Poland, 2004, data in mg per kg; unless stated expressly, material and sample location not given

No.	Building	CN ⁻	CN ^{-*}
1, 2	Auschwitz, Block no. 1, dwelling quarters	0-0.004	ND
3	Auschwitz, Block no. 1, as #1,2, iron hook	0	ND
4	Auschwitz, Block no. 1, as #1,2, wood from door	0	ND
5	Auschwitz, Block no. 1 (disinfestation facility)	0	ND
6		0.84-0.9	0.8-0.9
7, 8		0-0.016	ND
9, 10	Auschwitz, dwelling quarters Block 3	0	ND
11, 12	Auschwitz, dwelling quarters Block 8	0	ND
13-15	Auschwitz, cellars of Block 11	0-0.028	ND
17-19,21,22	Crematorium I	0-0.08	ND
20		0.288-0.292	0.3
25	Crematorium II	0.592-0.64	0.6
26-30		0-0.168	ND
31		0.288-0.296	0.3
32-38	Crematorium III	0.008-0.068	ND
39,40,42,43	Crematorium IV	0-0.044	ND
41		0.496-0.500	0.5
46	Crematorium V	0.232-0.248	0.2
47-52		0-0.248	ND
53, 54	Birkenau, Bathhouse, Camp Section B1-A, materials taken from the outer side of the building	0-0.036	ND
53a		0.224-0.248	0.2
55		0.64-0.74	0.6-0.7
56	Ditto, mortar from the outer side of the building wall	0-0.004	ND
57, 58	Ditto, plaster from dark-blue stains inside the building	0.324-0.84	0.3-0.8
59	Ditto, plaster from white walls inside the building	0.028	ND
60-63	Birkenau, dwelling quarters Block 3	0	ND

* Values as they should have been rendered if abiding by the proven detection threshold of the method.
ND = not detected

ions with heavy metals are more durable. Among such compounds is the already mentioned 'Prussian Blue' [=Iron Blue], but even this decomposes slowly in an acid environment.

One could hardly expect, therefore, that building materials (plaster, brick) exposed to environmental influences (precipitation, acid oxides, especially sulfuric and nitric monoxide) would contain derivative compounds of cyanides after a period of 45 years."

This contradicts the facts established above, and so to repeat:

- a) Carbon dioxide is only slightly soluble in water and hardly forms carbonic acid in water at all (see chapter 6.5.6.); actually, the water is primarily responsible for the decomposition.
- b) Iron Blue (Prussian Blue) is extraordinarily stable in acids and is not destroyed by the influences of weathering, even over decades (chapter 6.6.).

In a private exchange of correspondence with Werner Wegner, Prof. Markiewicz displayed his ignorance once again:⁵²⁵

"VIII. Water activates many chemical processes. The chambers were certainly moist. What kind of influence this exerts upon the binding of HCN by cement (wall plaster) – is unknown to us. [...]

IX. The blue stains on the exterior walls of building 5a are not easily explained. Above all, we must examine whether or not it is actual Berlin Blue [=Iron Blue...]"

In a later study, these authors published additional analysis results of samples taken later, using the same analytic method. According to these analyses, the cyanide concentration of samples taken in a disinfestation chamber and in alleged homicidal "gas chambers" were in the range of 0.0 to 0.9 and 0.0 to 0.6 mg/kg, respectively (see Table 19). This study also discussed the selection of the analytical method.⁶² This was said to have been selected because the authors could not imagine how blue iron cyanide compounds could form in the masonry:

"It is hard to imagine the chemical reactions and physicochemical processes that could have led to the formation of Prussian blue in that place."

They furthermore assume, together with J. Bailer,^{56,58} that the blue pigmentation of the disinfestation chamber walls could be due to a coat of paint. To exclude this pigmentation from the analysis, they decided to apply a method which is insensitive to iron cyanides.

⁵²⁵ Letter from the Prof. Dr. Jan Sehn Institute for Forensic Research, Department for Forensic Toxicology, Krakow, to W. Wegner, undated (winter 91/92), (illegible signature) unpublished.

An exchange of correspondence with myself in 1995 once again revealed the general incompetence with which the Polish researchers approached this set of problems.^{63,64}

A more detailed discussion of the Polish findings appears in chapter 8.4.2.

8.3.3. G. Rudolf/Fresenius Institute

Only a few samples were taken from the alleged homicidal “gas chambers.” Care was taken to ensure that samples were only taken from material not exposed to weathering. Only a few places in Morgue 1 (the alleged “gas chamber”) in Crematorium II at Birkenau, where a pillar supports the roof even today and has therefore visibly protected both the underside of the roof and parts of the wall from all influence of weathering, exemplified by the deposition of spider webs many years old and the absence of any trace of lime precipitation on the concrete or mortar, which would be caused by rain water.

Many samples have already been taken from the alleged “gas chambers” by the Krakow team and Leuchter, all with at least nearly negative results. Since it was above all a matter of clarifying the question of which circumstances favor the formation of pigment and since clearly positive findings were not to be expected according to the analyses performed in the alleged “gas chambers” thus far, the sample gathering took place chiefly in the disinfection chambers of buildings 5a and 5b in construction section Ia and/or Ib. It is known that their walls not only contain large quantities of pigment, but that their age also corresponds approximately to that of the crematoria on the same location, which cannot be said of the buildings in the main camp. The age can, but need not, have an influence on the chemistry of the wall materials. Furthermore, these buildings are not so much in the spotlight of the museum activity as those in the main camp, and therefore rather permit hope of an absence of subsequent building alterations.

Finally, samples were taken from a few inmate barracks to examine Leuchter’s argument that low cyanide traces could also result from a few fumigations for pest control. The numbering of the barracks corresponds to those found on the barracks today.⁵²⁶ See also Fig. 12 in this regard.

⁵²⁶ J.-C. Pressac, *op. cit.* (note 72), p. 514, plan of Birkenau camp with barracks numbering.

Table 20: Cyanide concentrations in masonry of "gas chambers" / delousing chambers According to G. Rudolf/Institut Fresenius, Taunusstein, Hessen, Germany						
Concentration values in mg per kg: %Fe: Portion of total iron content converted to Iron Blue, assuming that all detected cyanide was present as Iron Blue.						
No	Building	Sampling location and depth	Material	c[CN ⁻]	c[Fe]	%Fe
1	Crema II	Morgue 1, ceiling, between 2. and 3. supporting pillar from the south, removal of material from a broad area, concrete drips incl. a small piece of deeper material, 0-3 mm.	Concrete	7.2	13,000	-
2	Crema II	as 1, 1-5 mm.	Concrete	0.6	20,000	-
3	Crema II	Inner side of western wall of Morgue 1.0-1.5 cm, see Figure 42 (page 109).	Plaster	6.7	10,000	-
4	Crema II	Inner side of the northern wall of the chimney wing, garbage	Plaster	0.1	11,000	-
5	B1b Barrack 20	Wall separating berth, underneath the crossing beam of one bed in the large room, 2nd row of berths from the entrance, first berth to the right (separating wall), ca. 5 · 5 · 5 cm ³ big.	Plaster	0.6	9,400	-
6	B1b Barrack 20	Separate room in the west, interior wall, mortar between bricks, 0-1 cm.	Mortar	<0.1	4,400	-
7	B1b Barrack 20	as 6, at the entrance directly to the right, 0-1 cm.	Plaster	0.3	19,000	-
8	B1b Barrack 13	as 5, behind beam rest.	Plaster	2.7	11,000	-
9	B1a BW 5a	Inside of external wall (West), 120 cm from northern wall, 155 cm from the floor, 0-2 mm.	Plaster	11,000.0	12,000	75
10	B1a BW 5a	Internal wall (south), 240 cm from western wall, 170 cm from the floor, 0-2 mm.	Plaster	3.6	10,000	-
11	B1a BW 5a	as 9, 1-10 mm.	Plaster	2,640.0	6,000	36
12	B1a BW 5a	Eastern wall (inside), 170 cm from northern wall, 170 cm from floor, (eastern hot air chamber), 0-2 mm.	Plaster	2,900.0	8,500	28
13	B1a BW 5a	as 12, 2-10 mm.	Plaster	3,000.0	9,000	27
14	B1a BW 5a	Outside western wall, 40 cm from southern wall, 160 cm from the ground, 0-5 mm.	Brick	1,035.0	25,000	3.5

Table 20 continued: Analyses results Rudolf/Fresenius

No	Building	Sampling location and depth	Material	c[CN ⁻]	c[Fe]	%Fe
15a	B1a BW 5a	Outside southern wall, 40 cm from western wall, 210 cm from the ground, 0-3 mm.	Mortar	1,560.0	10,000	13
15b	B1a BW 5a	as a, > 0.5 mm, with pigment layer removed.	Brick	56.0	n.b.	-
15c	B1a BW 5a	as b, removed pigment layer, < 1 mm.	Brick	2,400.0	n.b.	-
16	B1b BW 5b	Outside southern wall, 2 m from entrance door, 1 m from the ground, 0-7 mm.	Brick	10,000.0	47,000	17
17	B1b BW 5b	Inside southern wall, 130 cm from eastern wall, 130 cm from the floor, 4-10 mm.	Plaster	13,500.0	15,000	74
18	B1a BW 5a	Floor area of door post of hot air delousing chamber, eastern chamber, pointing to the main wing, 0-5 mm.	Wood	7,150.0	n.b.	-
19a	B1b BW 5b	Inside northern wall, 230 cm from eastern wall, 90 cm from the floor, 0-4 mm.	Plaster	1,860.0	4,300	35
19b	B1b BW 5b	as 19a, 4-8 mm.	Plaster	3,880.0	9,500	33
20	B1a BW 5a	Inside exterior wall (west), 40 cm from southern wall, 210 cm from the floor, 0-3 mm.	Plaster	7,850.0	11,000	59
21	B1a BW 5a	Interior wall (east) from western wall, 30 cm from door, 190 cm from the floor, 10-50 mm.	Mortar	0.3	18,000	-
22	B1a BW 5a	Inside of exterior wall (south), 40 cm from western wall 155 cm from the floor, 3-10 mm.	Plaster	4,530.0	11,000	34
23	B1a Barrack 3	Special room northwest, inside exterior wall (north), 0-5 mm.	Plaster	0.3	8,100	-
24	B1a Barrack 3	Main room inside exterior wall, (north), 0-5 mm.	Mortar	0.1	13,000	-
25	Experiment	Untreated brick, 0-5 mm.	Brick	9.6	35,000*	-
26	Experiment	16 h in 0.3 vol.% HCN, 0-5 mm, see text.	Brick	0.1	35,000*	-
27	Experiment	24 ¾ h in 2 vol.% HCN, +1 g H ₂ O, 20 mm, 100 g.	Cement Mortar	109**	8,800*	1.0
28	Experiment	as 27, without added H ₂ O, 108 g.	Cement Mortar	94**	8,800*	0.9
29	Experiment	as 28, 94 g.	Lime Mortar	53**	4,500*	1.0
30	Experiment	as 28, + 2g H ₂ O, 96 g.	Lime Mortar	58**	4,500*	1.1

CN⁻ values between 0.1 and 0.5 mg/kg are considered uncertain (NN); n.d.=not determined; *=own analyses; **= Institut für Umweitanalytik, Stuttgart (IUS).



**Institut
Fresenius**

Chemische und Biologische
Laboratorien GmbH

6204 Taunusstein-Neuhof
Telefon 06128/744-0
Teletex 6128925 bios d
Telefax 06128/744890

Dipl.-Chem. Germar Rudolf

Pr.Nr. 91TA065282-65310
Unsere Auftrags-Nr. 91/13946-00

09. September 1991
Herr H. Gorbauch/Wa
06128 / 744-337

Untersuchung von Baumaterial auf die Gehalte an Eisen und Cyaniden
Ihr Schreiben vom 22.08.91

Eingang der Proben: 23.08.91 (überbracht)

Untersuchungsergebnisse:

Pr.Nr.	Probenbezeichnung	Eisen, gesamt (Fe) %	Cyanide, gesamt (CN) mg/kg
91TA065282	Probe Nr. 1	1,3	7,2
91TA065283	Probe Nr. 2	2,0	0,6
91TA065284	Probe Nr. 3	1,0	6,7
91TA065285	Probe Nr. 4	1,1	0,1
91TA065286	Probe Nr. 5	0,94	0,6
91TA065287	Probe Nr. 6	0,44	<0,1
91TA065288	Probe Nr. 7	1,9	0,3
91TA065289	Probe Nr. 8	1,1	2,7
91TA065290	Probe Nr. 9	1,2	11.000
91TA065291	Probe Nr. 10	1,0	3,6
91TA065292	Probe Nr. 11	0,60	2.640
91TA065293	Probe Nr. 12	0,85	2.900
91TA065294	Probe Nr. 13	0,90	3.000
91TA065295	Probe Nr. 14	2,5	1.035

...



**Institut
Fresenius**

Chemische und Biologische
Laboratorien GmbH

6204 Taunusstein-Neuhof
Telefon 06128/744-0
Teletex 6128925 bios d
Telefax 06128/744890

Blatt 2 zum Schreiben vom 09. September 1991

an:
Dipl.-Chem. Germar Rudolf

Pr.Nr. 91TA065282-65310

Pr.Nr.	Probenbezeichnung	Eisen, gesamt (Fe) %	Cyanide, gesamt (CN) mg/kg
91TA065296	Probe Nr. 15a	1,0	1.560
91TA065297	Probe Nr. 15b	n.b.	56
91TA065298	Probe Nr. 15c	n.b.	2.400
91TA065299	Probe Nr. 16	4,7	10.000
91TA065300	Probe Nr. 17	1,5	13.500
91TA065301	Probe Nr. 18	n.b.	7.150
91TA065302	Probe Nr. 19a	0,43	1.860
91TA065303	Probe Nr. 19b	0,95	3.880
91TA065304	Probe Nr. 20	1,1	7.850
91TA065305	Probe Nr. 21	1,8	0,3
91TA065306	Probe Nr. 22	1,1	4.530
91TA065307	Probe Nr. 23	0,81	0,3
91TA065308	Probe Nr. 24	1,3	0,1
91TA065309	Probe Nr. 25	n.b.	9,6
91TA065310	Probe Nr. 26	n.b.	0,1

* = Werte für Cyanide (gesamt) zwischen 0,1 und 0,5 mg/kg unsicher

n.b. = nicht bestimmt

INSTITUT FRESENIUS GMBH

8.3.3.1. Samples 1-4: Crematorium II, Morgue 1

On the taking of samples 1 to 3, see Figure 28 (page 86). An extremely high concentration of cyanide on the surface of the material must generally be expected. To investigate this, sample 1 contains, principally, concrete prongs from the ceiling/underside of the roof (caused by wooden planking), that is, the most exposed part of the concrete, as well as material from the uppermost layer of concrete, 1 to 2 cm thick, including a piece up to a depth of approximately 3 mm.

Sample 2 contains concrete to a depth of 5 mm, taken from the place at which the piece extending inward up to a depth of 3 mm was obtained in sample 1.

Separation between material from the topmost layer (sample 1) and lower layers (sample 2) was not entirely possible due to the extreme hardness of the concrete.

Sample 3 is a harder plaster, obviously rich in cement, extending to the first row of bricks.

Sample 4 originates from the plaster of the concrete beam in the chimney wing (rubbish incineration) of Crematorium II. It is only interesting as a control sample in addition to the others.

The results lie in the same order of magnitude as Leuchter's positive findings from other alleged "gas chambers," although Leuchter had no positive results in samples from Morgue 1 ("gas chamber") of Crematorium II. The difference between samples 1 and 2 may indicate that a

Table 21: Analysis results from the Institut Fresenius and the Institut für Umweltanalytik, Stuttgart (IUS)			
In both cases the cyanide demonstration took place according to DIN 38405/D13. Data in mg CN ⁻ per kg.			
Sample	Sample taking location	Fresenius	IUS
3	Morgue 1 ("gas chamber"), Crematorium II, wall plaster 0-1.5 cm	6.7	< NG
8	1b barracks 13, partition wall of berth, 3-5 cm	2.7	< NG
11	B1a, building 5a, interior side of exterior wall (west), 1-10 mm	2,640.0	1,430*
25	Untreated brick	9.6	9.6
26	3 additional samples of fumi-gated brick	-	<NG*
* This sample was examined according to DIN 35 405/D14. Here in contrast to D13 no cadmium salt was added. Nothing is known as to the effects on the results. Demonstrable threshold (NG) in each case 0.5 mg per kg.			

depth profile is actually prevalent in the concrete. Table 21 shows a list of control analyses. Sample 3 mentioned above with a low positive result of 6.7 mg/kg now has a value below the detectable threshold (0.5 mg per kg). This confirms the statement made in chapter 8.2. that values near the detectable threshold are not reproducible.

8.3.3.2. Samples 5 to 8 and 23, 24: Inmate Barracks

Samples 5 and 8 are from a large lump of plaster a few centimeters thick taken from the large room of the respective barracks (see Table 20, p. 239). A depth profile was not drawn up; the values must therefore be viewed as average values. Samples 6 and 7 are from the special room located at the west end of these barracks. Samples 23 and 24 are from the exterior wall of the large room of a third barrack.

Quantities of cyanide on the order of magnitude of those found by Leuchter in the alleged “gas chambers” can apparently also be found in the wall material of the inmate barracks. This is indicated by the results of sample 8. All others are also positive, but notably lower. In this case as well, the control analysis (Table 21, p. 243) failed to yield reproducible results.

8.3.3.3. Samples 9 to 22: Disinfestation Building

With regards to the sample taking locations of the individual samples, see Figs. 18f. Judging from the consistency, the material used to build the brick walls of buildings 5a and 5b is a mortar rich in sand but extremely poor in cement (extremely crumbly), covered with a lime mortar plaster.

Building 5a: What is remarkable about the outside of the exterior walls of the disinfestation chamber of BW 5a is that, in places, it exhibits blue bricks and mortar joints (see 68, above). Sample 14 is a loose fragment of brick which is clearly dark blue at all points facing outwards and therefore exposed to weathering. Sample 15a is mortar from the south wall, only the topmost layer of which was blue to a depth of approximately 1 mm. The cyanide value at this point must have been above the average value of the first approximately 3 mm. Sample 15b is a fragment of brick, the blue layer of which was separated with a spatula (sample 15c). The mass of the remaining fragment amounted to approximately twenty times the layer scratched off; only slight cyanide concentrations are detectable here. The average concentration here must have been around 120 mg/kg. On the brick as well, the pigment has only formed in perceptible quantities on the outermost side, that which

is exposed to weathering (in this regard, see the exterior wall of the disinfestation chamber in Stutthof concentration camp, Fig. 65).

Very important is the confirmation of the fact that the pigment actually possesses an enormous environmental resistance, since samples 14 to 15c were exposed to intensive sunshine, wind, rain, etc. for more than 40 years. But how did the pigment arise in such high concentrations at this precise location, although the outside of the exterior walls were not exposed to any direct fumigation? The low quantities of cyanide which diffused through the masonry are apparently sufficient to enable the formation of pigment on the outside of the wall, which was moist, especially during rainy weather, and its iron compounds were certainly massively activated by environmental influences.

The inside of the exterior walls of the disinfestation wing of building 5a are almost completely blue, even dark blue (see Fig. 69, below). Interestingly, the pattern of the brick structure located below the plaster has made an imprint on the intensity of Iron Blue formation in the upper layer of the plaster. Such a phenomenon is similar to, *e.g.*, the well known condensation of excessive atmospheric humidity on cool walls (for example, in large groups of sweating human beings, such as at rock concerts, in discotheques, or, generally, in poorly heated rooms), which also leads to the formation of patterns exhibiting the underlying brick



Fig. 68: The outside of the external wall of hydrogen cyanide delousing wing of building 5a in August 1991. Small amounts of cyanide which diffused through the walls are discoloring them at places still today. 50 years of the most detrimental environmental influences did not change this fact.

structure of such walls. Differently-baked bricks have a different tendency towards accumulation through condensation due to their differing heat conductivity. Differing reactivity to the formation of cyanides due to differing moisture contents and temperatures may therefore be the cause of this effect, but also differing transport capacities for migrating cyanide salts due to differing moisture contents.

Underneath the first layer of wall plaster, only approximately 1 mm thick, the material appears, by contrast, pale blue, just like the entire east wall of the wing, which is an interior wall of the original disinfestation chamber and whose discoloration is much less intensive (samples 12 and 13).

The interior walls of the same room, which were incorporated at a later time, *i.e.*, those belonging to the hot air disinfestation chamber (see Fig. 19), exhibit, as expected, no trace of blue.

The results of samples 9 and 11, and 20 and 22, resp., confirm the first impression. The topmost layer of plaster on the inside of the exterior walls has a very high cyanide concentration; underneath, the concentration decreases. The high cyanide concentration of sample 11 could not, however, be exactly reproduced. The result of the control

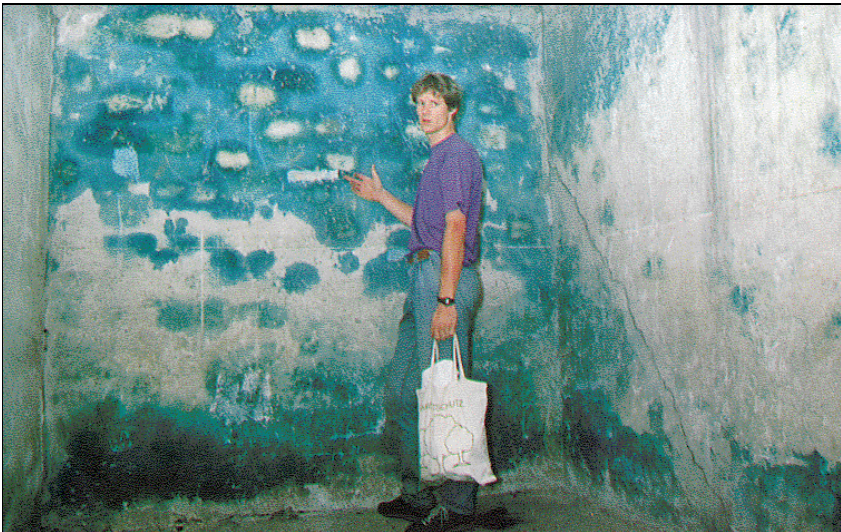

Fig. 69: Picture of a room located in the northwest of the disinfestation wing of building 5a (see Figure 19). The exterior walls are located in the background and to the right, showing intensive blue discolorations caused by iron Blue. Taking locations of samples 9 and 11 are visible. On the left in the picture is the interior wall, erected during the conversion to a hot air disinfestation chamber. Sample 10, with a slightly positive cyanide content, was taken from this wall.



Fig. 70: Picture of the door frame in disinfestation wing of building 5a. the lower, rusty hinge has developed Iron Blue under the influence of hydrogen cyanide. Sample taking location of sample no. 18.

analysis lies at only 54% of the first value. The slightly different analytical procedure may be responsible for this (see footnote in Table 21).

In pure Iron Blue, there is approximately 0.82 gram of iron for each gram of cyanide. The iron analysis, assuming that the cyanide is present completely in the form of Iron Blue, shows that, in sample 9, approximately $\frac{3}{4}$ of all iron was converted to pigment. If one considers that not all iron can be reached by the hydrogen cyanide, then one can speak of a near-saturation of the upper layer of material with the pigment. The drop in the concentration from the topmost layer to the lower layers is explained, for one thing, by the linear gradient which must be expected in non-isolated walls (see chapter 7.3.2.3.). Furthermore, as with the blue pigmentation of the exterior of the walls, the effect of accumulation of cyanides on the surface through evaporation of water carrying soluble cyanide compounds must be considered, even though this effect was certainly smaller on inside walls than on outside walls due to lack of air exchange in these rooms after the war (high relative humidity of the air, no wind), and due to the lack of sun activity in the room equipped with windows facing northwards only, see Fig. 69.

Samples 12 and 13 correspond to samples 9 and 11, taken from the interior wall only, from the east wall, near one of the hot air chambers. The surface concentration is considerably lower than on the inside of the exterior walls, there is no recognizable concentration profile. The

reason for this may be that the dry walls allow the hydrogen cyanide to diffuse more easily into the masonry, while the hydrogen cyanide more readily reacts superficially on the moist exterior walls. It is more probable, however, that no migration of soluble cyanide salts to the surface took place in the interior wall due to dryness. These samples are also interesting insofar as they prove that high quantities of cyanide compounds, highly-resistant for long periods of time, can form on warm and dry interior walls. Due to the high ground water table in Birkenau, as well as due to the lack of an effective heat insulation, the exterior walls must be expected to have been quite cool and moist even when the interior was heated, particularly during the cool seasons.

The samples from the walls added during the conversion to hot air disinfestation should exhibit no cyanide residues. Accordingly, sample no. 10 from the interior wall incorporated at a later time exhibits only a very low cyanide concentration near the detectable threshold. Sample 21 was taken from the mortar between the bricks of the wall installed later, at a depth of 1 cm to 5 cm into the masonry. There is a crack in the masonry of the interior wall at this location. The analysis shows minimal but hardly interpretable traces of cyanide below the detectable threshold in this interior wall as well. This finding may indicate disinfestation of these rooms after the conversion to hot disinfestation, if the slight quantities have not in any case lost all probative value, like the



Fig. 71: In contrast to building 5a (see Fig. 68), the disinfestation wing of building 5b was used as a hydrogen cyanide delousing chamber for a longer period of time. Subsequently, the outside of its walls are covered with blue spots, unimpressed by 50 years of weathering here as well.

control analyses of the other samples have shown.

Sample 18, finally, was taken from the door frame, which was only incorporated after the conversion to hot air disinfestation. Below the lower hinge, the wood exhibits a visibly blue pigmentation (see Fig. 70, p. 247). The pigment was able to form here due to the moisture in the floor, in connection with the rusting iron. This is assuming that the rooms were either charged with hydrogen cyanide after the conversion of the installation or that the floor of the installation continued to give off cyanide over longer periods of time. In the first case, the cyanide traces in the walls added later (samples 10 and 21) could actually be explained by fumigation of the rooms. However, during the conversion of this wing to a hot air disinfestation facility, this gas-tight door may have been removed from the access way to this wing and re-used here, so that the cyanide would result from earlier fumigations. The analytical results should only be conditionally considered as qualitative, since organic material can be a disturbing factor during analysis. In any case, the high reactivity of moist iron oxide mixtures (rust) is confirmed.

Building 5b: The exterior walls of disinfestation wing BW 5b are not only blue in places, as in the case of BW 5a, but rather, almost completely so, even below the ground (see Fig. 71, below). An exception here is the east wall, which hardly exhibits any blue pigmentation (see Fig. 20, p. 70). The analysis of a fragment of brick from the south side (sample 16) therefore shows an extremely high value. Here, the pigment extends farther into the masonry. Here as well, weathering has had no visible or measurable effect on the pigment concentration. Approximately 17% of the iron in the fragment of brick has been transformed into pigment, despite the only slight concentration in cyanides able to reach the exterior of the masonry wall here as well. The conspicuous difference between Building BW 5b and 5a, which is only blue in places, is explained by the longer period of use of the 5b wing as a Zyklon B disinfestation chamber. The reason for the perceptibly lesser blue pigmentation of the east side of the exterior wall of this wing can be explained by the lesser influence of weathering on this side (east winds are mostly accompanied by dry weather in eastern Europe).

When examining the interior of this wing, one is surprised by the walls, which are mostly white. Pale green stains are visible only in a few places. The analysis of the green-colored plaster underneath the upper layer, sample 17, however, shows the highest value found anywhere, despite the thick layer of plaster consisting of a compact, very hard material, 3 to 4 mm thick. With relation to the transformation of

the iron, what was said of the upper layer of plaster in BW 5a only, is true here: near saturation. The color of the material, here only greenish, is apparently not directly meaningful with regards to the cyanide concentration. Because even in the presence of maximum values, the proportion of pigment in the plaster only amounts to 1.5 %, the intense blue color in places on the surface of the inside of exterior walls of BW 5a cannot moreover be explained in this manner. Rather, the dark blue colors result from a still higher concentration of pigment in the uppermost layers in the micro-meter range of magnitude caused by the accumulation processes of migrating, soluble cyanide salts as described above.

That these accumulation processes did not occur on the surface of the inside of building 5b may be explained by the different type of material and its preparation. The hard, iron-poor interior plaster of lime mortar adheres very poorly to the wall and is already falling off in some places. The contact between plaster and wall is so poor in places, that when one knocks on the wall, one hears that there is a hollow space beneath. Such weak contact between wall and plaster, however, prevents moisture in the wall from diffusing through to the surface plaster and carrying soluble cyanide compounds (for example, iron(II)-cyanide) with it.

Sample 19 was divided in two, since the upper layer of plaster in this room is visibly different from the layer lying beneath: The first 4 mm of plaster consists of a white, brittle, hard material (sand-poor lime plaster), while the layer underneath consists of an ochre-colored, sand-rich lime plaster. The separation was not completely successful; parts of the sand-rich mortar remain in sample 19a. The analysis for iron, which might possibly have been even lower in the presence of complete separation, confirms the assumption that the upper layer is an iron-poor lime plaster. This explains the deficient formation of blue spots of pigment on the surface of the plaster in this room, since there is too little iron available for the formation of pigment. Nevertheless, even the upper layer of plaster exhibits quite high cyanide values. This shows that the layer of plaster was not applied after termination of the disinfestation actions.

8.3.3.4. Samples 25-30: Tests

For an evaluation of the reactivity of hydrogen cyanide with building materials, a series of tests was undertaken; during the first series, only brick was fumigated with hydrogen cyanide, generated from a defined

quantity of $\text{KCN} + \text{H}_2\text{SO}_4$ in a gas-tight container. Over the course of the tests, it became apparent by means of sensitive differential pressure measurements that only a part of the hydrogen cyanide added to 16% sulfuric acid was released as gas. Hydrogen cyanide is so easily soluble, even in this acid, that only a portion of it is actually released into the gas room. The actual quantity of gas in the reaction container therefore lay far below the mathematically calculated 3.7% by volume, while the pressure measurements consequently lay around 2 % by volume.

Regarding the design of the reaction container from a glass cylinder, sealed above and below by PVC plates with gas outlets and sealed with rubber O-rings, see Fig. 72. 16% H_2SO_4 was placed in a crucible, KCN was added by means of a magnetic lever mechanism with the container sealed. The mixing was performed by means of a magnetic stirrer.

The samples listed in Table 22 were analyzed. The following parameters were kept constant:

- 11°C air and sample temperature;
- 90% relative atmospheric humidity;
- Storage of the samples for approximately five weeks under these conditions prior to initiation of the tests;
- Sealing of the samples on all sides, except for one frontal surface, with paraffin 52/54⁵²⁷ (thus fumigation on one side only);
- Fumigation with 2% by volume hydrogen cyanide;
- 24.75 hours fumigation time;
- Storage of the samples after fumigation at room temperature and low atmospheric humidity for 71 days.

Exceptions from these conditions are listed in the right column of Table 22 (p. 252). Following fumigation,

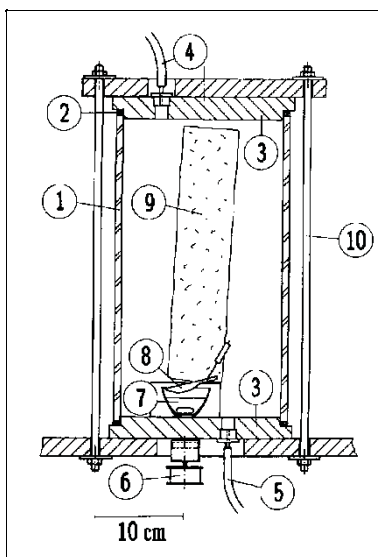

Fig. 72: Construction drawing of the experimental container for the fumigation of material samples with hydrogen cyanide.

- 1: Glass cylinder
- 2: O-sealing ring
- 3: PVC lid and floor plate
- 4: Gas outlet and pressure gauge
- 5: Gas ventilation outlet
- 6: Magnet mixer motor
- 7: Porcelain dish with 16 vol.% H_2SO_4 and magnet mixer
- 8: Spoon with KCN fixed axle, capable of tipping over magnet from exterior
- 9: Sample material (here brick)
- 10: Bolts

⁵²⁷ Melting point between 52 and 54°C.

the topmost layers of the sealed surfaces of samples 27 to 30 were removed, and hence the sealing layer of paraffin. The additionally moistened samples 27 and 30 made themselves perceptible by an intense odor of hydrogen cyanide during storage at room temperature, in contrast to samples 28 and 29 which were only moist by nature. The odor of hydrogen cyanide disappeared suddenly upon additional moistening. In the case of the cement mortar sample, the odor was no longer perceptible after a week, while in the case of the lime mortar sample, it was no longer perceptible after two weeks. Storage of the samples for more than two months at room temperature therefore perceptibly reduced the hydrogen cyanide content, while the drying of the samples strongly hindered the conversion to iron cyanide.

The analytical results relating to the brick samples (Table 20, p. 239, sample no. 25 and 26) are surprising for their values, which appear paradoxical: the fumigated sample, in contrast to the unfumigated sample, exhibited no traces of cyanide. The value of the unfumigated sample could be exactly reproduced (Table 21). Further analyses of the fumigated brick likewise resulted in no demonstrable cyanide concentrations. These findings prove that cyanide values up to 10 mg per kg have only very limited probative value, since these can be attributed to traces which occur everywhere.⁵²⁸

Table 22: Test sample preparation and fumigation

Nr.	Material	Conditions
25/26	Brick from demolished building from Bavaria; only sample 26 was fumigated!	16 h fumigation with 0.3 vol.%, Storage after fumigation for 120 days at room temperature. No sealing with paraffin
27	Cement mortar: 1 part sand, 1 part Portland cement, ½ part lime. Sample measurements: 55×60×20 mm, 100 g (ca. 1.5 g/cm ³)	addition of 1 g water
28	Cement mortar: 1 part sand, 1 part Portland cement, ½ part chalk. Sample measurements: 55×60×20 mm, 108 g (approx.. 1.6 g/cm ³)	
29	Lime mortar: 2 ½ parts sand, 1 part lime. Sample measurements: 55×60×20 mm, 94 g (ca. 1.4 g/cm ³)	
30	Lime mortar: 2 ½ parts sand, 1 part lime. Sample measurements: 52×58×20 mm, 96 g (ca. 1.6 g/cm ³)	addition of 2 g water

⁵²⁸ It is also conceivable that the unfumigated samples were contaminated during preparation for analysis, perhaps through an improperly cleaned ball mill, in which samples with a high cyanide content had previously been crushed. The reason for the good reproducibility may be that there is hardly any carbonate in brick, since it acts as a disturbance ion.

The interpretation of the analytical results of samples 27 to 30 resulted in the following data:

- In total, 30 mg of cyanide were found in the samples during the analysis. Since 300 mg cyanide were used during this test, 10% of this quantity was found durably bound to the samples.
- The cement mortar samples, in contrast to the lime mortar samples, exhibit a higher cyanide concentration by a factor of two. The higher iron content of the cement mortar samples may be the reason for this, since the cyanide content increases proportionally to the iron content (see the last column of Table 20). In addition, hydrogen cyanide adsorption was certainly favored by the higher inner surface area of the cement mortar as compared to lime mortar.
- The increased hydrogen cyanide absorption caused by the addition of moisture was only slightly perceptible in the analytical results, since the samples were all very moist anyway, and because the material dried out during the final storage phase and therefore the hydrogen cyanide was only able to bind partially.
- Blue pigmentation of the samples was not to be expected, since even if all the bound cyanide were present in the form of Iron Blue, only 0.005-0.01% of the total material would consist of the blue pigment, which would cause hardly any perceptible coloration to the naked eye. An accumulation of cyanides on the surface of the sample, finally, could not occur due to the absence of water in diffusion. In addition, the dry storage of the samples probably blocked the conversion process.

8.3.4. John C. Ball

John Ball took samples from various locations, but according to his published data (see Table 23), he either had each group of samples taken at a specific location analyzed together or else he calculated an average of each location and published only the average. Hence his data cannot be used for any detailed analysis.

All samples taken from alleged homicidal “gas chambers” (no. 3-6) are around or well under the detection threshold and must therefore be considered zero. From these samples, only sample group no. 3 (taken from Morgue 1 of Crematorium II) has a well-defined history. Ball’s samples results from the delousing wings of buildings 5a and 5b do represent a fairly good average of my own results and therefore confirm them.

Table 23: Cyanide concentrations in the masonry of “gas chambers”/disinfestation chambers according to John C. Ball⁵²⁹

No.	Location	c(CN ⁻) [mg/kg]
1	Delousing Room B1b BW 5b, inside and outside	3,170.0
2	Delousing Room B1b BW 5a, inside and outside	2,780.0
3	Crematorium II, Morgue 1 (“gas chamber”)	0.4
4	Crematorium III, Morgue 1 (“gas chamber”)	1.2
5	White Farm House, remnants of foundation	0.07
6	Crematorium V, remnants of foundation wall	0.1

8.4. Discussion of the Analysis Results

8.4.1. Blue Wall Paint?

The hypothesis expressed by J. Bailer,^{56,58} that blue paint could be responsible for the high cyanide values in the disinfestation chambers, does not correspond to the facts:

1. Iron Blue is not sold as wall paint at all, since it lacks sufficiently high lime fastness (see chapter 6.6.1.).

2. If this argument were correct, it would be remarkable that the SS, of all the rooms in the Third Reich, would apply blue paint only to their disinfestation chambers where no one could admire it; and, strangely, always the same blue. All other rooms were whitewashed. Were the SS practitioners of “blue magic”?

3. The disinfestation chambers themselves already had a coat of lime paint. Why would they cover this coat of lime paint with another paint which, in addition, is not even lime fast? They would therefore have had to wait until the lime paint and plaster had set before one could paint the walls. And then it would have been by no means certain that the paint would not furthermore have become stained as a result of chemical reactions.

4. A coat of paint on the interior of the room would not explain the patchy pattern of the blue stains on the interior of the exterior walls of the disinfestation wing of building 5a.

5. Neither would a coat of paint on the interior of the room explain the absence of blue coloration on the interior walls added to the disinfestation wing at a later time. Or are the SS supposed to have painted only certain walls, and then, not evenly, with paint brushes, but, perhaps, soiling the wall statistically by throwing and spattering?

⁵²⁹ John Clive Ball, *The Ball Report*, Ball Resource Services Ltd., Delta, BC, Canada, 1993.

6. Bailer's argument is refuted by the fact that none of the colored walls shows any pattern of brush marks, and no identifiable coat of paint, since wall paint consists not only of pigment, but also of a not inconsiderable proportion of binding agents and other chemicals. The blue pigment is, however, simply one component of the lime paint and plaster.

7. Bailer's argument furthermore fails to explain how the artistic skills of the painters could have succeeded in imitating the brick structure lying beneath the plaster. Or did they not only practice "blue magic," but were equipped with X-ray eyes as well?

8. Bailer's argument does not explain the only pale blue tint of the interior south walls of the original disinfection wing of building 5a.

9. Neither does Bailer's argument explain the high cyanide concentration in the superficially white, iron-poor material of the walls of the disinfection wing of building 5b. Or is it his opinion that these rooms were, perhaps, painted with an "iron white," a paint color that does not even exist?

10. Bailer's argument furthermore fails to explain the still higher cyanide concentration of deeper, greenish-bluish coats of material in the walls of the disinfection wing of building 5b; or does he perhaps intend to argue that the SS even applied iron-blue paint to wall plaster and wall mortar where no one could ever admire it? There, it would in addition have certainly have been decomposed into its component parts due to the alkaline pH value of fresh mortar and would have lost its color at least temporarily.

11. Finally, Bailer's argument cannot explain why even the exterior walls of the disinfection rooms, exposed to weathering, have a notable cyanide content and are discolored with blue stains. Or did the SS employ the technique of statistically throwing and splashing paint about here as well, paying particular attention to the structure of the brick, resisting at all times the temptation to apply the coats of paint which are so typical of ordinary painting, simply because blotchy blue-stained brick is so sexy? Or was the Iron Blue applied to the bricks upon manufacture, resisting the baking process of the brick in a magical fashion known only to the blue-magic SS?

The Polish scientists, as indicated above, adopted Bailer's argument and therefore preferred simply not to prove the presence of Iron Blue at all. *Honi soit qui mal y pense...* (a rogue is he who thinks evil of it)

8.4.2. False Method of Analysis

Many people, both experts and laymen, rely good-naturedly upon the findings of the Jan Sehn Institute for Forensic Research in Krakow, *i.e.*, the study published in 1994 by Prof. Markiewicz and colleagues. These Polish scientists, however, tested their samples with an analytical method that was unable to detect stable iron cyanide compounds. They did this because they could not imagine how such stable iron cyanide compounds could form. It is, of course, no shame to fail to understand something initially. Anyone, however, who makes a claim to scientific reliability must, before making statements upon the subject, at least attempt to investigate and understand. But not so the Polish scientists. They assert their lack of understanding as a justification for their failure to act. Has anyone ever heard that failure to understand a phenomenon was any reason for scientists *not* to study it? To the Polish scientists, this was obviously the case. It would only be permissible to exclude Iron Blue from the study if it were possible to *exclude*, with practical certainty, that the effects of hydrogen cyanide on masonry could result in the formation of iron cyanide, and, consequently, Iron Blue, and if there were at least some indication that these rooms had been painted with Iron Blue or that there could conceivably be any other reason for its presence. The Polish scientists completely neglected to do this. And even worse: they did not even attempt to refute my arguments on the formation of stable iron cyanide compounds which I published in early 1993.⁵³⁰ They were familiar with this publication, because they quoted it, yet not in order to discuss my arguments, as would have been expected, but simply to condemn it flatly as an example of the allegedly diabolical deeds of the “deniers” and the “whitewashers” of Hitler, who Prof. Markiewicz and his colleagues intended to refute – in their own words. This should suffice to show that the Polish actions were ideologically motivated to a high degree. If they had been neutral scientists, they would have applied the correct and interpretable method of analysis and would have discussed my publications in a scholarly manner instead of worrying about Hitler’s dirty laundry.

Prof. Markiewicz and his colleagues did not even attempt to find any explanation for the high iron cyanide concentration in the walls of the disinfestation chambers and their blotchy-blue surfaces.

⁵³⁰ E. Gauss, *Vorlesungen über Zeitgeschichte*, Grabert, Tübingen 1993, pp. 163-170; 290-294.

Table 24: Orders of magnitude of analytical results
of various samples, in mg CN⁻/kg

Author:	Markiewicz <i>et al.</i>	Leuchter	Rudolf	Ball
Results from:	Cyanide without iron cyanide	—— Total cyanide ——		
delousing chambers:	0-0.9	1,025	1,000-13,000	2,780-3,170
“gas chambers”:	0-0.6	0-8	0-7	0-1.2

Although they had sought out an analytical method able to produce the results desired by them, the results of their first series of tests were obviously so disturbing that they decided to suppress them and never published them. These data only became public knowledge through an act of indiscretion in 1991 (see chapter 8.3.2.).⁵³¹

The Polish scientists therefore rejected the undesired results of their first series of tests and took even more samples, until they finally produced the results that fitted in with their preconception: this time, both the samples from the disinfestation chamber and the alleged “gas chambers” showed cyanide residues on the same order of magnitude⁶² – although in most cases they were clearly below the detection limit of the method they had chosen. So strictly speaking, most of their results should show “ND” = not detected, instead of ridiculously low amounts which are beyond the reliability of their method.

But even Prof. Markiewicz and his colleagues, during the test fumigations performed by them, at least confirmed that moist cement mortar (as was used in the morgues of Crematoria II and III) absorbs at least ten times more hydrogen cyanide than dry lime mortar (as used in the disinfestation chambers), as I had assumed for my calculations in this work.

Table 26 shows the analysis results of Prof. Markiewicz and his colleagues compared to those of Fred Leuchter, John C. Ball, and mine.

I will spare the reader any further discussion of these results, because analysis results obtained in a methodically incorrect manner cannot be corrected even by correct interpretation. Any attempt at interpretation is therefore a waste of time.

A few words, however, are due on the HCN-CO₂ mixture used by the Poles for their fumigation experiments. They claim that CO₂ has a

⁵³¹ The first series of studies, undertaken by J. Markiewicz, W. Gubala, J. Labedz, and B. Trzcinska, were never published by the authors of the studies. Only the revisionists have published their findings, after the article was smuggled out of the Jan Sehn Institute by unknown persons in 1991; see also note 61; for further remarks on this example of “political science,” see G. Rudolf, *op. cit.* (note 63).

Table 25: Influence of CO₂ on the Absorption of HCN
According to Markiewicz et al.

Data in mg CN⁻/kg (values below 0.2 mg/kg are equivalent to ND = not detected)

Material:	Fresh Plaster		Fresh Mortar	
	dry	moist	dry	moist
Exposed to 2% HCN +: no added CO ₂	(0.024) ND	0.48	(0.176) ND	2.7
10% CO ₂	5.92	12.8	0.492	0.388
<i>Factor</i>	<i>247</i>	<i>27</i>	<i>3</i>	<i>0.14</i>

negative influence on the adsorption of HCN in the masonry. Their own (worthless) test results, however, contradict this view, see Table 25.

First of all, the Poles failed to define what they mean by “plaster,” “mortar,” “old,” “fresh,” “dry,” and “moist,” so this experimental series, apart from having used the wrong method of analysis, is also completely irreproducible due to the lack of any kind of definition of the materials used.

Next, the apparent absorption of cyanide by fresh plaster (dry and moist) and by dry mortar obviously increased in the presence of CO₂ (factors: 247 for dry, 27 for moist plaster, 3 for dry mortar) – yet the Poles had the nerve to categorically claim the opposite! Only in one case (moist mortar) did the absorption decrease (factor 7; the Poles did not test the influence on “old” material).

Again, since their flawed analytical method renders any interpretation of these results futile, I will not do this here. All this shows is that Markiewicz et al. obviously do not even get the basics of scientific experimenting and data interpretation straight.

I will come back to Markiewicz once more when discussing R. Green in chapter 8.4.4., though.

Even a direct comparison with my arguments and the open expression of suspected fraud could not move Prof. Markiewicz and his colleagues to justify or correct their unscientific behavior.^{63,64} The director of this group, Dr. Jan Markiewicz, who is not a chemist, but rather, a “technical testing specialist,” died in 1997. Both of his colleagues have remained silent.

One can understand that these Polish authors made their careers in Communist Poland, and, as Polish patriots, they feel that they can under no circumstances permit the undermining of “Auschwitz” as a moral justification for the Polish ethnic cleansing of the East Prussians, East Pomeranians, and Silesians after the end of World War Two, as a result of which some three million Germans lost their lives, as well as it being the greatest land robbery of modern history. Many Poles fear in their

hearts that the post-war state of Poland stands and falls with Auschwitz. This may explain Prof. Markiewicz's and his colleagues' scientific contortions, but it fails to be a justification for them. Even the possible circumstance that the scientists assigned to the topic were not and are not chemists and that their laboratory was perhaps not equipped up to Western standards, cannot explain this, since an analysis of the total cyanide concentration is not expensive in terms of laboratory equipment and the chemistry involved is anything but complicated.

The manner with which the Polish scientists approached the problem, however, gives rise to serious suspicion that this was an attempt at scientific fraud, a suspicion which is also supported by the fact that they were unable to justify their incorrect analytical method except through their incompetence and ignorance.

The conclusions to be drawn from the above is clear: the only "scientific" attempt to refute Fred A. Leuchter's sensational argument proves, upon closer examination, to be one of the greatest scientific falsifications of the 20th century.

How desperate must one really be, if it is believed necessary to stoop to such methods in an attempt to defend the established version of the Holocaust, *i.e.*, the alleged systematic extermination of the Jews in homicidal "gas chambers"?

8.4.3. The Memory Hole

At the end of chapter 6.6.5., I already referred to the bold lies of Albert Meinecke from the German press agency DPA regarding the alleged short life term of hydrogen cyanide in masonry. A new corny joke was recently added to this debate by Prof. James Roth from the Alpha Analytic Laboratories, Ashland, Massachusetts. I discuss this event here because Prof. Roth's allegations were widely publicized by the international media in connection with the libel case of British historian David Irving against Deborah E. Lipstadt.⁵³²

For his documentary movie *Mr. Death* on Fred A. Leuchter, Errol Morris also interviewed Prof. Dr. James Roth. In 1988, Roth's laboratory had analyzed the masonry samples from the alleged "gas chambers" taken by Leuchter in Auschwitz for their cyanide content. During the trial against Ernst Zündel in Toronto that same year, for which the Leuchter report had been produced, Prof. Dr. Roth himself was interro-

⁵³² This claim played a role in the verdict which should not be underestimated, cf. judgment Gray, *op. cit.* (note 71), §13.79; cf. note 73.

gated as an expert witness. Ten years later, Errol Morris interviewed Roth about this event. During this interview, Prof. Roth did all he possibly could to distance himself from the possible consequences of the analyses performed by his company. His interview gained importance only due to the fact that the Dutch architectural historian Prof. Robert van Pelt quoted Roth in his 1999 expert report prepared for the Irving trial. In it, van Pelt wrote about Roth's statements in Morris' movie:⁵³³

"Roth explained that cyanide will react on the surface of brick or plaster, penetrating the material not more than 10 microns, or 0.01 mm, or one tenth the thickness of a human hair [...]. In other words, if one wants to analyze the cyanide concentration in a brick sample, one should take a representative sample of the surface, 10 microns thick, and no more."

It can be shown that Prof. Dr. James Roth is wrong for the following reasons:

1. It is a fact that the walls of the disinfection chambers in Auschwitz, Birkenau, Stutthof, and Majdanek are saturated with cyanide compounds, and this not only superficially, but into the depth of the masonry, as I have proved by taking samples from different depths of the wall, compare in this regard especially my samples no. 11, 13, 17, 19b, and 23 in Table 20. They prove that hydrogen cyanide can rather easily reach deep layers of plaster and mortar. But even the other samples taken from the surface prove that Prof. Roth's allegation is wrong: Provided that most of the cyanide detectable today is present in the form of iron cyanide (Iron Blue and other cyanoferrates), as Prof. Roth assumes himself, his thesis would mean that 10% to 75% of the iron content of these samples are located in the upper 10 micrometers of my samples (0.010 mm), *i.e.*, they are located in less than 1% of the entire sample mass, and the rest of the sample would have been massively deprived of iron. How this migration of a major portion of iron to a thin surface layer would have happened is inexplicable to me.
2. Furthermore, expert literature is detailed in that
 - a) hydrogen cyanide is a extremely mobile chemical compound with physical properties comparable to water,³³⁸
 - b) which can quite easily penetrate through thick, porous layers like walls.⁴²⁷
3. In addition, it is generally known that cement and lime mortar are highly porous materials, comparable for instance with sponges.⁵³⁴ In

⁵³³ Pelt Report, *op. cit.* (note 71), p. 307.

⁵³⁴ DIN 4108, part 3 to 5, deals with diffusion of steam into building materials. The most important coefficient for building materials is the so-called coefficient of diffusion resistance; this is a

such materials, there does not exist something like a defined layer of 0.01 mm beyond which hydrogen cyanide could not diffuse, as there can also be no reason, why water could not penetrate a sponge deeper than a millimeter. Steam, for example, which behaves physically comparable to hydrogen cyanide, can very easily penetrate walls.

4. Finally, the massive discolorations of the *outside* walls of the disinfection chambers in Birkenau and Stutthof, as shown in this expert report, are clearly visible and conclusive evidence for the fact how easily hydrogen cyanide and its soluble derivatives can penetrate such walls.

As a professor of analytical chemistry, Prof. Roth must know this, so one can only wonder why he spreads such outrageous nonsense. That Prof. Roth is indeed a competent chemist can be seen from what he said during his testimony under oath as an expert witness during the above mentioned Zündel trial:⁵³⁵

“In porous materials such as brick or mortar, the Prussian blue [recte: hydrogen cyanide] could go fairly deep as long as the surface stayed open, but as the Prussian blue formed, it was possible that it would seal the porous material and stop the penetration.”

Prof. Roth might have felt obligated to attack Leuchter in order to avoid becoming himself a target of certain lobby groups who already managed to destroy Leuchter’s career. That would explain why the truth temporarily dropped into a hole in Prof. Roth’s memory while being interviewed by Errol Morris. It is also revealing that Prof. Roth mentioned during this interview, if he had known where Leuchter’s samples originated from, his analytical results would have been different. Does that mean that Prof. Roth manipulates his result according to whether or not he likes the origin of certain samples? Such an attitude is exactly the reason why one should never tell an “independent” laboratory about the origin of the samples to be analyzed, simply because “independence” is

dimensionless number indicating how much longer the diffusion of steam takes to penetrate a layer of certain materials compared to the time it takes to diffuse through the same layer of still air. This coefficient is valid not only for water vapor, but also for gaseous hydrogen cyanide as well as for any other gas. In the list of 100 different building materials compiled in DIN 4108 part 4, one can find lime and cement mortar with diffusion resistances from 15 to 35, in which case the resistance grows with increasing cement content; for gypsum plaster, the coefficient is 10, for brick walls 5 to 10, for glass wool mats it is 1. That means, if a gas diffuses through a layer of still air with a speed of 1 cm per second, it takes 15 to 35 seconds to diffuse through a 1 cm thick layer of lime or cement mortar and 5 to 10 seconds to diffuse just as deep into a brick wall. (I am grateful to Mr. C.H. Christmann for this reference.) In this regard, compare also the analysis about the porosity of masonry, graph 7, p. 172.

⁵³⁵ B. Kulaszka (ed.), *op. cit.* (note 28), p. 363 (protocol p. 33-9291).

a very flexible term when it comes to controversial topics. What Prof. Dr. Roth has demonstrated here is only his lack of professional honesty.

8.4.4. The Moon is Made of Pizza

Another strange story is that of Richard Green, a self-confessed Jew⁵³⁶ and PhD chemist with a similar educational background as I have.⁶⁸⁻⁷⁰ The layman would expect two experts, with similar educational background, to come to similar conclusions in questions relating to their expert knowledge. But this is only partly the case. The reason for this is that Dr. Green ignores many facts that are either supported by documentary evidence – like the performance of the ventilation installed in Crematoria II and III, or the speed of executions in U.S. execution chambers – or by expert literature – like the higher tendency of cold, moist walls to adsorb HCN, and the longer lasting alkalinity of cement mortar compared to lime mortar.

However, Dr. Green makes some concessions which are important to note:

- a) He agrees that basically all witnesses attest to very short execution times, indicating a rather high concentration of HCN used.
- b) He also agrees “that Rudolf is correct or nearly correct regarding the formation of blue staining in the delousing chambers.”

What he does challenge, though, is the possibility of formation of any noticeable quantities of Iron Blue in the homicidal “gas chambers.” One of his flawed and deficient arguments to support his thesis is that in his view, no noticeable amounts of cyanide could have accumulated in the walls of the morgues (“gas chambers”). According to Dr. Green, one major factor for this is supposed to be the fact that masonry has a neutral pH value which does not allow the protolysis of hydrogen cyanide and thus the formation of cyanide salts. But if that were true, how come huge amounts of cyanides did accumulate in the walls of the disinfestation chambers?

My argument in this regard is that particularly cement plasters and concretes, as used in morgues I of Crematoria II and III, are noticeably alkaline for many weeks, months, or even years, which I documented thoroughly with expert literature on the chemistry of building materials (see chapter 6.7.2.). Hence, I concluded that these walls would have been very much inclined to accumulate cyanide salts and to form Iron

⁵³⁶ See his polemic exchange with A.S. Marques, www.codoh.com/newrevoices/nrmarques/nrmgreen.html, where he stated in the mid 1990s: “Liar, I am a Jew and I receive no reparations.”

Blue, even more so than the lime plaster of the disinfection chambers, which in turn provoked the following answer by Dr. Green:⁵³⁷

“[In 1993] *The IFRC* [Institute for Forensic Research, Krakow], *on the other hand measured the pH* [of mortar samples from the alleged gas chambers] *to be between 6 and 7* [i.e. neutral].”

Dr. Green obviously did not consult any literature on the chemistry of building materials, as he quotes none. He solely relies on the findings of the Krakow institute. In order to make the reader see how flawed Dr. Green’s way of arguing is, let me say it in a parable:

By referring to a couple of Italian expert pizza baking instructions, I showed that a pizza, when taken out of the oven, is hot or warm for quite a while (one hour). Now, Dr. Green comes along claiming that I am wrong because a Polish friend of his has just now measured the temperature of a pizza which was baked a week ago, and which has been lying around somewhere since. And the Polish scientist found out that this pizza is indeed cold right now. Surprise, surprise!

Of course, samples taken from the surface of walls erected 50 years ago or more are now pH neutral! Even this I have proved by showing how the front of neutralization slowly migrates into concrete and mortar (see chapter 6.7.2.2.). But what does the pH value of samples taken 50 years after the erection of these buildings prove regarding their pH value shortly after they were built? Dr. Green’s way of arguing is childish to the highest degree.

When it comes to intellectual honesty, Dr. Green reveals some other very strange behavioral patterns, one of which I want to address here.

Dr. Green agrees with me that the Iron Blue found in delousing chambers is the result of gassings with hydrogen cyanide. Hence he disagrees with the opinion of Markiewicz and others that this Iron Blue may have its origin in residual paint (no wall paint containing cyanides exists). However, Green comes up with his own auxiliary hypothesis to shore up his ongoing defense of the Krakow frauds: He invents a scenario during which items “soaked with aqueous solutions of HCN” were leaned against such walls.⁵³⁸ Now, how exactly would the SS have obtained such a solution, and how would items have gotten soaked with it? By throwing Zyklon B into water and then using this solution to soak lice-infested clothing? Is Dr. Green out of his mind?

One major rule of science is that it is impermissible to immunize a theory against refutation, here in particular by inventing untenable aux-

⁵³⁷ R.J. Green, J. McCarthy, op. cit. (note 70); repeated in R.J. Green, op. cit. (note 218), p. 50, again without any attempt to address the issue by resorting to expert literature.

⁵³⁸ R.J. Green, op. cit. (note 218), p. 18.

iliary hypotheses to shore up an otherwise shaky thesis.⁵³⁹ This is exactly what Dr. Green is doing: coming up with a ludicrous attempt at explaining a fact which does not fit into his theory. Yet instead of fixing his theory, he tries to fix reality.

Let me draw a historical parallel here. When Galileo Galilei discovered with his telescope that the moon was not a perfectly smooth sphere, which had been the doctrine among astronomers ever since Aristotle, his opponents were outraged:⁵⁴⁰

"[Galileo] reasoned to no purpose with the slaves of the ancient schools: nothing could console them for the destruction of their smooth, unalterable surface, and to such an absurd length was this hallucination carried, that one opponent of Galileo, Lodovico delle Colombe [...] attempted to reconcile the old doctrine with the new observations, by asserting, that every part of the moon, which to the terrestrial observer appeared hollow and sunken, was in fact entirely and exactly filled up with a clear crystal substance, perfectly imperceptible by the senses, but which restored to the moon her accurately spherical and smooth surface. Galileo met the argument in the manner most fitting, according to Aristotle's own maxims, that 'it is foolish to refute absurd opinions with too much curiosity.' 'Truly,' says he, 'the idea is admirable, its only fault is, that it is neither demonstrated nor demonstrable; but I am perfectly ready to believe it, provided that, with equal courtesy, I may be allowed to raise upon your smooth surface, crystal mountains (which nobody can perceive) ten times higher than those which I have actually seen and measured.'"

If Dr. Green were honest, he would dismiss the misleading approach of the Krakow team to exclude Iron Blue from the analysis, because this would most likely exclude the major parts of the cyanide residues formed by gassings with HCN in general (not just in the case of delousing chambers). Even if we agree to disagree on what has happened at Auschwitz during the war, we surely can agree that Markiewicz et al. did not use cyanide paint to color the samples they themselves prepared for their gassing experiments or that they leaned them against items "soaked with aqueous solutions of HCN." So why did the Krakow team not at least analyze the samples from their own experiments with the international standard method of detecting the *total* cyanide content? Or at least they should have used both methods side by side, which would have enabled us all to compare the results of both methods and thus evaluate what they are worth. This in turn could have shed a lot of light

⁵³⁹ Cf. Karl R. Popper, *The Logic of Scientific Discovery*, Hutchinson & Co., London 1968, pp. 82-97.

⁵⁴⁰ John E. D. Bethune, *Life of Galileo Galilei*, William Hyde & Co., Boston 1832, pp. 105f.; <http://books.google.com.mx/books?id=MQYCAAAAYAAJ>

on chemical processes as well, like: how fast is HCN absorbed in mortar converted into insoluble iron cyanides no longer detectable with the one, but readily detectable with the other method? If we hold the results of my test gassings against those conducted by the Poles, then it appears that most of the absorbed cyanide present in gassed mortar samples is turned into long-term stable iron cyanides rather quickly. But since the conditions of our experiments were very different, such a conclusion would be premature. The Poles had the chance to find out. I had asked them to redo their tests with the standard method, but they did not react to that suggestion.

Subsequently, if Dr. Green were honest, he should say that the Polish scientists neither tried to understand what they claimed not to have understood, nor discussed the attempts to understand as made by others, which were known to them. No matter which results the Polish scientists produced and what their scientific opinion might have been: their behavior is extremely unscientific, as **the most important task of a scientist is to try to understand what has not been understood so far, and to discuss the attempts of others to make it understandable.** The Polish scientists did just the opposite: they decided to ignore and exclude what they did not understand. Finally, in their article as well as in a letter to me, the Polish scientists themselves stated that the purpose of their paper was to refute the “Holocaust Deniers” and to prevent Hitler and National Socialism from being whitewashed, *i.e.*, their purpose was *not* to find out the truth! Thus, by their own confession, they used unscientific methods in order to produce desired results for the purpose of achieving certain political goals.

Let me quote Prof. A.R. Butz in this connection, who stated another appropriate metaphor to emphasize the degree of intellectual dishonesty revealed by Markiewicz and his colleagues:⁵⁴¹

“The argument [of Markiewicz et al. for excluding Iron Blue from their analyses], to the extent that it was intelligible enough to be summarized at all, was that they did not understand how the iron-cyanide compounds got to be there, so they decided to ignore them in reaching their conclusions. I don’t understand how the moon got there, so I will ignore all effects associated with it, such as tides. I hope I don’t drown.”

And the amazing thing about Dr. Green is that he – and with him Prof. van Pelt, who relies on Green⁷⁴ – does not only defend Prof. Markiewicz’s behavior in every regard, but he attacks me for my critique against the Polish scientists, while omitting *all the reasons* I gave for

⁵⁴¹ Arthur R. Butz, “Historical Past vs. Political Present,” *JHR*, 19(6) (2000), pp. 12ff.

doing so. To crown this, Dr. Green even defends the fact that Prof. Markiewicz never bothered to address any part of my critique, even though addressing critiques is paramount for scientists. Dr. Green argues:

“Rudolf complains that Markiewicz et al. have not responded to his queries. Why should they do so? What credibility does Rudolf have, that demands they answer his every objection no matter how ill-founded?”

However, since Dr. Green agrees that the Iron Blue detectable in disinfestation walls *is* the result of gassings with Zyklon B, he himself has indirectly admitted that all my objections against Markiewicz’s method of analysis are well-founded, *i.e.*, just the opposite of “ill-founded.”

And why does Dr. Green think I bear no credibility demanding a discussion of any of my arguments? Not because I lack scientific qualifications. No, he thinks I am an abomination because of my views, and because I have been subject to social persecution and political prosecution, leading to the total destruction of my social existence, my reputation, and finally my freedom. Dr. Green even resorts to calling me a “liar,” “obfuscator,” and “hater” because of my different well-founded opinions. And to top it all off: when I *defend* myself against his *ad hominem* attacks, he lambastes me for that as well.⁵⁴² So, whereas he has a right to attack me, I don’t have a right to defend myself?

The scheme is as follows: first, people like Dr. Green attempt to do everything to destroy my reputation by name-calling, persecution, and prosecution, and when they succeed, they claim that there is no need to discuss anything with me anymore, since I do not have any reputation and credibility anyway. This way they can nicely ignore any argument refuting their flawed thesis. And they have the chutzpah to call themselves righteous scientists and to call me a pseudo-scientific liar and obfuscator of the truth.

Dr. Green unconditionally defends the scientific frauds from the Krakow institute, and both get away with it, because in the eyes of the public, both have the “politically correct” “scientific” opinion about Auschwitz. Birds of the same feather flock together.

⁵⁴² Richard J. Green, “Postscript to Chemistry is not the Science: Rudolf’s Character Suicide,” July 2000, www.holocaust-history.org/auschwitz/chemistry/not-the-science/postscript.shtml

8.4.5. Wikipedia – Wiki-Lies

Wikipedia is probably the world's most frequently consulted encyclopedia. In its English language entry about Germar Rudolf one can read:

“However, like Fred Leuchter in the Leuchter report, Rudolf did not discriminate against the formation of iron-based cyanide compounds, which are not a reliable indicator of the presence of cyanide, and his experiment was thus seriously flawed. This report has been critically analyzed by Richard J. Green and Jamie McCarthy from The Holocaust History Project.”

As is demonstrated throughout this book, it is utter nonsense to claim that “iron-based cyanide compounds [...] are not a reliable indicator of the presence of cyanide.” Not even Green has ever made such a nonsensical statement. In fact, Green's and, in extension, Markiewicz's position is that iron-based cyanide compounds are not a reliable indicator of *past homicidal gassings*. In chapters 8.4.2. and 8.4.4. it has been amply demonstrated why this position is untenable.

Any attempt to get this statement corrected or at least amended failed, as such changes were deleted only minutes later. Even an innocuous addition like “Rudolf's findings were eventually published in English in his book, *The Rudolf Report*, where he addresses the science community's response, including Green's criticism,” was deleted by the censors at Wikipedia almost instantly.⁵⁴³ Not even a bibliographic listing of the *Rudolf Report* was tolerated. Hence the Wikipedia entry about Rudolf is on the alarm list of several people who are monitoring every change and who make sure that bias and lies prevail.

8.4.6. Anticipated Values

The only case of the formation of Iron Blue through fumigation with hydrogen cyanide, which is fairly well documented, is the case of damage to churches in Bavaria as cited above.^{24,25} Even today, buildings are fumigated with hydrogen cyanide, yet Iron Blue is rarely formed. The reason for this, however, is quite obvious. Fumigation with hydrogen cyanide is used to kill vermin, such as woodworm, meal moths, corn beetles, or lice. However, a massive case of vermin infestation requiring the use of hydrogen cyanide occurs, in practice, only in buildings which have already been in use for relatively long periods of time, *i.e.*, many

⁵⁴³ In the entry's revision history, see the changes of Sept. 17, 2009 (10:51), which was reverted 91 minutes later, and of May 22, 2010 (17:08), which was undone 74 minutes later.

years. It is therefore to be expected that the interior plaster of such buildings has long since become thoroughly carbonized. Furthermore, the rooms to be fumigated are, as a rule, heated in order to enhance the effectiveness of the hydrogen cyanide (faster evaporation, slower adsorption losses, stimulated metabolism of vermin). Since it is not to be expected, according to the findings presented here, that a perceptible accumulation of cyanides, let alone the formation of Iron Blue, would occur after only one fumigation in warm, dry, and chemically set wall materials, one cannot be surprised that such building damage is the exception rather than the rule.

The damages to the churches in Bavaria are typical exceptions, since the unheated churches, notorious for their humid walls, had been plastered with cement mortar, which is known to remain alkaline for many months, only a few weeks before. These are exactly the conditions which in my view were favorable to the formation of Iron Blue. With increasing setting of the cement plaster over the course of months, the pH value of the masonry in the churches finally dropped, so that the final reaction led to the formation of Iron Blue, which is stable for long periods of time. This final reaction of the adsorbed cyanide into Iron Blue was only completed after approximately two years. The prior stage of this reaction, the formation of considerably paler iron cyanides, could already have been completed or well progressed prior to this.⁵⁴⁴

A comparison with the probable conditions of the disinfestation chambers and alleged homicidal “gas chambers” of the Third Reich is quite informative (see Table 26). The following assumes that both installations (tacitly assuming the existence of the homicidal “gas chambers”) were put into use more or less immediately after their construction, *i.e.*, at a time when the concrete, mortar and plaster were still not entirely set. In addition, they were in near-constant use for one to two years.

That the entire plaster job on the walls of the churches referred to above turned blue even after only one fumigation is explained by the especially (un)favorable circumstances. The alleged “gas chambers” of Crematoria II and III in Birkenau show a striking similarity to this case. These cool and moist cellar rooms were only completed shortly before they were put into service and are then said to have been exposed to

⁵⁴⁴ Incidentally, all the plaster in the church had to be knocked off the walls and replaced, since there was no other way to get rid of the Iron Blue. Communication from Konrad Fischer, head architect during the renovation of the church at that time.

Table 26: Comparison between cases of building damage, morgue and disinfestation chamber

LOCATION PROPERTY	PLASTERING OF CHURCHES	CREMATORIUM II/III MORGUE I	DISINFESTATION BW 5A/B
Iron Content	> 1 Weight.-%	1-2 Weight.-%	0.5-5 Weight.-%
Type of plaster	Lime + Cement	Cement (+lime?)	Lime
Alkalinity	Medium-term high	Medium-to-long-term high	Short-term high
Moisture	Moderately high (hydrophobic plaster, cool, moist church)	High (unheated cellar below ground water table, condensing sweat*)	Moderate (exterior wall) to low (interior room) (heated room)
Time elapsed between plastering and fumigation	A few weeks	Between a few weeks and three months*	(a few weeks?)
Number of fumigations	1	Allegedly $\geq 400^*$, in each case at least one hour	Probably < 400, in each case many hours
CO ₂ content	low	high*	low
Proof of cyanide	Clear	Negative	Clear (0.1-1 weight-%)

* = assuming the correctness of the alleged mass gassing scenarios

hydrogen cyanide on a constant basis, quite in contrast to the church mentioned above, which was only fumigated once.

The other major difference between the two cases is that only the normal atmospheric CO₂ concentration was present in the churches, whereas homicidal “gas chambers” would have had an elevated CO₂ level for the duration of the entire procedure (from the entrance of the victims to the ventilation of the chamber). The exact influence this would have had, if any, is not known. Testing this has always been beyond my own reach, as I could not afford the equipment to do experiments with added CO₂. This is a task for future research.

Finally, the interesting question of which analytical values were really to be expected, if the reported mass gassings with Zyklon B really occurred in the “gas chambers” at Auschwitz, must now be examined within what is possible.

First, consideration will be restricted to the morgues 1 of Crematoria II and III, since sufficient data are only available for these buildings and because it is only here that meaningful samples can be taken, since it is certain that the material is in its original condition.

As a comparative value, let us take two of the samples taken by myself from the interior wall of building 5a: samples no. 12 and 13, with a total cyanide concentration of 2,900 and 3,000 mg/kg, respectively.

The following is a list of individual properties which exert an influence upon the formation of Iron Blue.

1. Properties, which were approximately the same in both installations:
 - The (alleged) operating time (approximately 1 year).⁵⁴⁵
 - The (alleged) frequency of use (a few hundred times),⁵⁴⁶ even if a document quoted in chapter 5.2.3.5. states that shortly after the putting into operation of these hydrogen cyanide disinfestation chambers, a decision was made to stop using them, see. p. 65. It may therefore well be that the cyanide residues to be found in these disinfestation chambers today result from considerably fewer fumigations.
 - The (necessary) application concentration.⁵⁴⁷
 - Both installations were (allegedly) put into operation more or less immediately after completion.⁵⁴⁸
2. Properties that were advantageous to the formation of Iron Blue in the disinfestation chamber:
 - The duration of the fumigation times led, in the disinfestation chamber, to a concentration of cyanide in the masonry between 16% and 30% of saturation; in the case of the homicidal “gas chambers,” however, only to values of between 1.6% and 8% could be reached (factor 2-19).⁵⁴⁹
3. Properties which were advantageous to the formation of Iron Blue in the homicidal “gas chambers”:
 - The morgues possessed cool, moist walls, which have a higher tendency, higher by a factor of 8, to adsorb hydrocyanic than the warm, dry interior walls of the disinfestation chamber under consideration (factor 8).⁵⁵⁰
 - Ceilings and walls of the morgue consisted of cement mortar and/or concrete, which, due to their longer-lasting alkaline proper-

⁵⁴⁵ With regards to the homicidal “gas chambers,” the period between March 1943 and the fall of 1944 is “attested to.” Building 5a was completed in the fall of 1942 (*RGVA*, 502-1-214; acc. to 502-1-22-19, it was completed already by June 20, 1942), but converted to operate with hot air in the summer of 1943 (J.-C. Pressac, *op. cit.* (note 72), pp. 55-58; acc. to *RGVA*, 502-1-24, equipment of BW 5a and 5b with hot air disinfestation facility started on Nov. 1, 1942).

⁵⁴⁶ For the homicidal “gas chambers,” this follows from the alleged victim totals of several hundred thousand victims per chamber; for the delousing installations, this follows from the maximum number of days available in $\frac{3}{4}$ of a year (approximately 270 days).

⁵⁴⁷ See also chapters 7.1. and 7.3.1.3.

⁵⁴⁸ Crematorium II was completed in February/March, after which the gassings are alleged to have begun in mid-March or the end of March. With relation to the delousing installations, we have no data, but one may assume that the building was used as soon as it was completed, even if it must be expected that the delousing chambers could not be used for a while, since, for delousing, it was necessary first to install all the equipment after completion of the building, *i.e.*, undressing rooms, showers, saunas, heating, etc. The same applies, of course, to the crematoria/morgues.

⁵⁴⁹ See also chapters 7.3.2.2.f.

⁵⁵⁰ See also chapters 6.5.1., 6.5.3., 6.7.2.f.

ties and due to their greater specific inner surface area, are able to adsorb and bind hydrogen cyanide for a longer time and more strongly than the cement-poor mortar and plaster of the disinfection wing under consideration. Quantification in this regard is difficult, but a factor in excess of two must be anticipated (factor 2).⁵⁵¹

4. Property with an unknown influence:

- CO₂ content: whereas the disinfection chambers will have had a normal atmospheric concentration (0.33% at that time), the level will have been considerably above that in the morgues as soon as the victims assembled inside until the room was ventilated. As discussed in chapter 6.5.6., the effect of CO₂ on the formation of long-term stable cyanide compounds is not clear. Whereas a high CO₂ does lead to a fast carbonization and thus neutralization of lime mortar, rendering it chemically less active, this is not the case for cement mortar, the material used in the underground morgue. This material is carbonized only very slowly, hence it retains its activity to bind HCN for a longer period of time.

According to these considerations, and leaving aside the yet unknown influence of CO₂, the known factors indicate that rather more iron cyanide would have had to form in the homicidal “gas chambers” than on the interior walls of the disinfection chamber in question ($\frac{8 \times 2}{2 \text{ to } 19} \approx 0.4\text{-}8$). In actual fact, however, the homicidal “gas chambers” contain such low cyanide concentrations that they are neither capable of reproducible detection nor of adequate interpretation, but in any case at least some 150 to 10,000 times lower than those detectable in the walls of the disinfection chambers. It seems unlikely that CO₂ could be the reason for such drastic differences.

Or in plain English: When analyzing wall samples from the alleged “gas chambers” of Crematoria II and III, we ought to expect results which are in the same order of magnitude as the results of samples taken from the walls of the delousing chambers of BW 5a and 5b. What we do find in those “gas chamber” samples, however, is practically nothing. Unless, of course, it turns out that CO₂ really has a dramatic effect in reducing the reactivity of cement mortar to bind cyanides irreversibly.

⁵⁵¹ See also chapters 6.5.2., 6.7.2.f.

8.4.7. Limits of the Chemical Method

The most recent development in the official school of thought tends to modify the marginal conditions for the homicidal mass gassings, even when this stands in shattering contradiction to the statements of eyewitnesses or the technical data.

Whereas it was still the rule, until a few years ago, for the eyewitness testimonies to allege daily, or even continuous, gassings,⁵⁵² today it is occasionally assumed, as a result of the drastic reduction in the number of victims to a maximum of 630,000,⁴⁷² 470,000 to 550,000,⁴⁷³ or even 356,000 gassing victims,⁴⁷⁴ that there were considerably fewer homicidal gassings per “gas chamber” than hitherto believed.

There is furthermore a tendency towards a strong reduction in the alleged quantity of hydrogen cyanide utilized as compared, for example, to the quantities alleged by the eyewitnesses.^{53,58,59}

There is much unfounded fantasizing as to the existence of any ominous Zyklon B introduction devices, which would have permitted the toxic gas to be released through holes in the ceiling into the chamber – holes which, unfortunately, did not and do not exist – and to be removed again following conclusion of the gassings.⁵⁵³

Furthermore, the opinion is occasionally expressed that the homicidal “gas chamber” was sprayed with a water hose after every gassing. This assertion forgets that it would have lasted many hours until the “gas chamber” could have been cleared of bodies (they had to be cremated, which is time-consuming, after all) that the hydrogen cyanide does not merely sit on the surface of the wall, but rather, due to its extremely high diffusion capacity, penetrates deeply into the wall within a few hours, and that a water hose would be of no assistance in this regard, quite apart from the fact that such an action would have had the effect of causing the consequently extremely damp walls to adsorb even more hydrogen cyanide during the next hypothetical gassing. In addition, the samples taken from the ceiling, which was certainly not hosed down, likewise show no reproducible cyanide concentrations.

Yet there are also physical-chemical boundary conditions which can influence the analytical results. It is, for example, not inconceivable that, for whatever reason remaining unknown until the present time, the masonry of the alleged “gas chambers” was not, or only slightly, in-

⁵⁵² According, for example to the testimony of M. Buki in the Frankfurt Auschwitz Trial; see H. Langbein, *Der Auschwitz-Prozeß, op. cit.* (note 480), p. 96.

⁵⁵³ Pressac (note 72) and van Pelt (note 74) are true masters in the composition of such inventions. The court historians either fail to notice or deliberately ignore the fact that these fairy tales are not based upon documents or physical reality.

clined to the formation of Iron Blue, or that possible residues were destroyed for unknown reasons. CO₂ could be one such compound not factored in so far.

The assumptions made in relation to the boundary conditions relating to hypothetical homicidal gassings were naturally subject to particular reserves, since no empirical data were available in this regard. Thus the question of how quickly the hydrogen cyanide contained in Zyklon B could diffuse in hypothetical “gas chambers” and how quickly it could have caused the death of all victims cannot be answered with absolute certainty. The assumptions made here are, of course, generally well-founded, but are not infallible.

All of the above makes prediction with *certainty* of the quantities of cyanide which one might have expected to find in the masonry of the alleged “gas chambers” impossible. The anticipated cyanide values indicated above and the subsequently following, summarized conclusions are therefore only the well-founded conclusions of an expert; under no circumstances do they constitute dogmatic truth. An extensive series of tests, for which neither the time, nor the equipment, nor the money are available to me, would have been necessary under the most varied conditions for a better prediction of the expected values. In view of the importance of the topic, it would perhaps have been proper, after 65 years, for some renowned institute to begin with such investigations at long last.

Matters are different, however, when coming to conclusions based upon architectural and engineering questions. Because the structural fabric of some of the buildings under discussion has remained in its original condition and due to the extensive documentation available about them, we are able to arrive at concrete statements, especially regarding the absence of alleged Zyklon B introduction holes in Crematoria I, II, and III.

9. Conclusions

- ❑ Even according to the statements of pharmacist J.-C. Pressac, who, in the late 80s and early 90s, was promoted as *the* technical Holocaust expert, eyewitness testimonies relating to the engineering of the installations and their capacity are, almost without exception, untenable. But even the corrections to the testimonies considered by Pressac to be necessary do not go far enough to make them credible. In particular, the testimonies relating to the duration of executions in the “gas chambers” (Morgue 1) of Crematoria II and III, as well as the ventilation times after the executions go completely awry. This is because of the over-estimation of the evaporation rate of hydrogen cyanide from the carrier of Zyklon B, as well as the incorrect concept of the effectiveness of the ventilation of the rooms. If the eyewitness testimonies relating to the quantities of Zyklon B used, and at least approximately relating to the rapidity of the execution procedure are to be accepted, then they are incompatible with testimonies, sometimes of the same witnesses, that the victims’ corpses were removed from the “gas chambers” immediately after the executions and without gas masks and protective garments. This is particularly true for those alleged “gas chambers” without ventilation installations (Crematoria IV and V and farmhouses I and II), since working in poorly ventilated “gas chambers” with high concentrations of poison gas is impossible without gas masks. The extreme danger to the sweating workers of the *Sonderkommando*, who are supposed to have worked without protective garments, makes the witnesses untrustworthy. The eyewitness accounts are therefore completely contradictory, illogical, contrary to the laws of nature, and therefore incredible. The witnesses engage in particular contortions when it comes to the cremations (amount and kind of fuel used, speed of cremation, development of flames and smoke), which furthermore fail to accord with the analyses of aerial photography.
- ❑ The alleged installations for the mass murder of human beings are, in Pressac’s judgment, impractical for their purpose, but were, on the contrary, illogically constructed in parts, so that they would not have been suitable as instruments of mass extermination. Once one considers the actual technical requirements, the impression remains of the total inadequacy of the installations in question – which were deficient to the point of uselessness – in gross contradiction to the

technically advanced disinfestation chambers in the immediate vicinity. The facts set forth here with relation to Zyklon B introduction pillars in the ceilings of the "gas chambers" (Morgue 1) of Crematoria I to III strengthen the suspicion of a subsequent manipulation almost to a certainty. These installations would have been even less suitable than Crematoria IV and V. It would have been impossible to introduce the gas into them.

- Due to the proven, enormous environmental resistance of Iron Blue pigment, the slight cyanide traces in alleged homicidal "gas chambers," which are demonstrable in places, but are not reproducible, cannot be explained on the basis of remaining residues of a disintegration process, since even on the weathered exterior side of the disinfestation wing large quantities of cyanide can be found even today. Towards the end of the operating period of the installations, therefore, the cyanide content must have been present in the same order of magnitude as it is today, as well as in the areas which were never exposed to weathering. But the cyanide values of protected areas in the alleged homicidal "gas chambers" are just as low as in places exposed to weathering. Weathering has, therefore, not actually diminished these slight traces. The low cyanide values cannot be explained by fumigation of the premises for vermin, as postulated by Leuchter, since such fumigation would probably have left greater quantities of cyanide in the moist cellars of Crematoria II and III. The cyanide values of the alleged homicidal "gas chambers" lie in the same order of magnitude as the results, among others, of the samples taken by myself from parts of other buildings (hot air disinfestation building 5a, inmate barracks, the washroom of Crematorium I). These values, however, lie so near the detectable threshold that no clear significance can be attributed to them, most importantly due to their lack of reproducibility. From the above, one can safely conclude that *no* cyanide residues capable of interpretation can be found in the walls of the alleged homicidal "gas chambers."

It was further possible to show that, under the conditions of the mass gasings as reported by eyewitnesses in the alleged "gas chambers" of Crematorium II to V, cyanide residues would have been found in similar quantities, coloring the walls blue, as they can be found in the disinfestation wings of building 5a/b. Since no significant quantities of cyanide were found in the alleged homicidal "gas chamber," one must conclude that these installations were exposed to similar conditions as the above mentioned other installations (hot air disin-

festation, inmate barracks, washroom of Crematorium I), *i.e.*, that they most likely were never exposed to any hydrogen cyanide.

Final Conclusions

A. On chemistry

A: The investigation of the formation and stability of cyanide traces in masonry of the indicated structures as well as interpretation of the analytic results of samples of building material from these structures in Auschwitz show:

1. Cyanide reacting in masonry to produce Iron Blue is stable over periods of many centuries. It disintegrates on the same time scale as the masonry itself. Therefore, traces of cyanide should be detectable today in almost undiminished concentrations, regardless of the effects of weather. The outer walls of the delousing chambers BW 5a/b in Birkenau, which are deep blue and contain high concentrations of cyanide, are evidence of this.
2. Under the physically possible conditions of the mass-gassing of humans with hydrogen cyanide, traces of cyanide ought to be found in the same range of concentration in the rooms in question as they are found in the disinfestation structures, and the resulting blue discoloration of the walls should likewise be present.
3. In the walls of the supposed “gas chambers” the concentrations of cyanide remnants are no higher than in any other building taken at random.

Conclusion to A:

On physical-chemical grounds, the mass gassings with hydrogen cyanide (Zyklon B) in the supposed “gas chambers” of Auschwitz claimed by witnesses did not take place.

B: On building technology

The investigation of the events of alleged mass gassings in the indicated rooms claimed by witnesses, from a technical and practical standpoint, including physical-chemical analysis, showed:

1. The extensive documentation on the Auschwitz camp does not contain a single reference to execution “gas chambers”; rather it refutes such suspicions.

2. The supposed main gas chambers of Auschwitz, the morgue hall of the crematorium in the main camp and the morgue cellars I (“gas chambers”) of Crematoria II and III, did not have any means for the introduction of poison gas mixtures. Holes in the roofs visible today were made after the war, and all other cracks are the result of the building’s destruction at the end of the war.
3. The release of lethal quantities of hydrogen cyanide from the Zyklon B carrier requires many multiples of the asserted execution times.
4. Providing the necessary ventilation for the supposed “gas chambers” of Crematoria II and III would have taken many hours, contrary to all witness testimony.
5. It would have been impossible to provide an effective ventilation of the supposed “gas chambers” of Crematoria IV or V or of farmhouses I and II. The corpses could not have been removed from the rooms and carried away by the *Sonderkommando* without protective garments and the use of gas masks with special filters.

Conclusion to B:

The procedures of mass-gassing as attested to by witnesses during their interrogation before various courts of law, as cited in judicial rulings, and as described in scientific and literary publications, in any building of Auschwitz whatsoever, are inconsistent with documentary evidence, technical necessities, and natural scientific law.

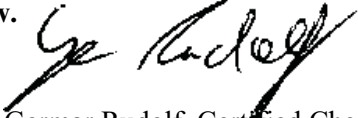

Germar Rudolf, Certified Chemist, in exile, on September 13, 2002.

Edited by Dr. Wolfgang Lambrecht, December 2010.

DECLARATION

The author of this report can refer only to the *existing* eyewitness testimonies and documents, which *alone* are the basis for the widespread historical viewpoint in the matters dealt with here.

If the conviction should nevertheless become prevalent that the eyewitnesses erred in their corresponding testimonies, then an expert can only confirm that there is no longer any basis upon which to draw up an expert opinion, and, in the opinion of this author, there will no longer be any basis upon which court judgments, a method of historiography established by criminal law, or criminal prosecution of certain statements could be based.

10. Acknowledgements

Unfortunately, I cannot thank everyone who was directly or indirectly involved in creating this expert report or who expressed their support. However, I do wish to express my gratitude to the following institutions and individuals:

- ⊗ The late Major General (retired) Otto Ernst Remer, whose forthright public statements were the reasons why this expert report became necessary in the first place.
- ⊗ Mr. Karl Philipp, whose initiative on behalf of MajGen. Remer and whose logistic support enabled me to prepare this report.
- ⊗ Dr. Robert Faurisson for critically reading the first manuscript in late 1991, and supplying me with abundant documentary material.
- ⊗ Certified engineer Winfried Zwerenz for providing rooms and equipment to conduct experiments, as well as useful observations regarding ventilation and cremation techniques.
- ⊗ Certified engineers Gerhard Förster, Emil Lachout, Arnulf Neumaier, Michael Gärtner, Harald Reich, Carl Hermann Christmann, R. Faßbender, and Konrad Fischer for their various support and research contributions.
- ⊗ Certified engineer Walter Lüftl for manifold comments and suggestions on questions of engineering.
- ⊗ Dr. Horst Leipprand and Otto Karl for their indispensable research on the properties of Zyklon B.
- ⊗ John C. Ball for his broader investigations of Allied air photos regarding Auschwitz.
- ⊗ Carlo Mattogno for his extremely detailed and productive critique as well as his excellent archival studies which he allowed me to use and quote extensively.
- ⊗ Friedrich Paul Berg for his very valuable research on executions with hydrogen cyanide in the USA.
- ⊗ Werner Wegner and Jan Markiewicz for their friendly correspondence in.
- ⊗ Dr. Myrosław Dragan for his productive critique regarding the inhalation of hydrogen cyanide by humans and for his instructive cremation experiments.
- ⊗ The late Charles D. Provan for his fruitful, though unfortunately unpublished, critique regarding the alleged Zyklon B introduction holes.

- ⊗ Attorneys Hajo Herrmann, Dr. Günther Herzogenrath-Amelung, Dr. Klaus Göbel, Jürgen Rieger and Dr. Herbert Schaller for their legal support.
- ⊗ Dr. Heinz Knödler, Linda M. Faith, Andrew Fuetterer, Dr. Fredrick Töben for proofreading various versions of this report.
- ⊗ Carlos Porter, Michael Humphrey, and James M. Damon for contributions getting this work translated from German into English.
- ⊗ Historians Dr. Rainer Zitelmann, Dr. Werner Georg Haverbeck, Dr. Hellmuth Diwald, Dr. Emil Schlee, Dr. Robert Hepp, Dr. Ernst Nolte, Dr. Walter Post, and Dr. Joachim Hoffmann for their encouragement.
- ⊗ Mrs. Elda and Dr. Robert H. Countess, who were there for me when I became a refugee and needed friends, who helped me build up *Theses & Dissertations Press* and launch the *Holocaust Handbooks* series. I particularly thank Bob, who discussed many details with me and did the final proofreading of the first edition.
- ⊗ *Forschungs- und Materialprüfungsanstalt* (Research and Material Testing Agency) Baden-Württemberg, Otto Graf Institut, Department 1: Building Materials, Stuttgart, for informative discussions and their permission to use their extensive literature.
- ⊗ *Forschungsinstitut für Pigmente und Lacke e.V.* (Research Institute for Pigments and Varnishes), Stuttgart, for permission to use their library.
- ⊗ *VARTA Batterie AG Research Center*, Kelkheim, for performing mercury penetration tests of building materials.
- ⊗ *Bundesarchiv-Militärarchiv* (German Federal Archive-Military Archive), Freiburg, for information regarding W.W. II era Soviet tank engines.
- ⊗ *Degussa AG* for sending information material on Iron Blue (trade name Vossen-Blau[®]).
- ⊗ *Detia Freyberg GmbH* and *ARED GmbH* for information on Zyklon B.
- ⊗ *Institut Fresenius*, Taunusstein, for providing insights into their procedural and analytic methods, and informative discussions about analytic problems.
- ⊗ *Institut für Umweltanalytik* (Institute for Environmental Analytics), Stuttgart, for assistance in the understanding of experimental control and analyses.
- ⊗ *Zentralrat der Juden in Deutschland* (Central Council of Jews in Germany), which, by its highly inappropriate intervention, encour-

aged my dismissal and assisted in preventing me from finishing my doctoral dissertation, foiling any prospect of pursuing a post-doctoral degree, and liberating me from the duties of a professional career, thus allowing me to dedicate 24 hours a day to revisionism.

- ⊗ The *University of Stuttgart* and the *Max Planck Institute for Solid State Research* in Stuttgart (MPI), which successfully prevented me from wasting my life in the ivory towers of science by denying my PhD and dismissing me without notice. However, I am also grateful that the MPI, through mutual agreement, converted my dismissal to an annulment of contract roughly a year later.
- ⊗ The Stuttgart District Court, the Tübingen County Court, the Böblingen County Court, the Weinheim County Court, the Berlin-Tiergarten County Court, the Munich County Court, the District Court Mannheim, as well as the *Bundesprüfstelle für jugendgefährdende Medien* (German Federal Review Office for Youth-Endangering Media) for trying to drown me in uncounted criminal prosecutions for my revisionist publications, which had the consequence of allowing me to pursue my revisionist publishing activities in exile, undisturbed by the terror of the German authorities.
- ⊗ Lastly, I wish to acknowledge the German and British media for their innumerable inflammatory articles and newscasts, forcing me into seclusion and a more focused devotion to revisionism.

Part II:
Persecution:
Hunting Germar Rudolf

1. What Makes Revisionists?

Bavarian Nostalgia

During the early 1980s, in my last three years at high school, I developed a passion for everything Bavarian: the soccer team *Bayern München*, Lederhosen, the dialect, and, of course, the Bavarian Party, the CSU,⁵⁵⁴ which exists in Bavaria only. I also became a fan of Franz-Josef Strauß, who for many decades was chairman of this party and became kind of a symbol for everything Bavarian. I surely would have joined the CSU, also because of its strong conservative views, but unfortunately this party was open only to those residing in Bavaria, where I never lived.

At that time, I also joined the youth organization of Germany's semi-conservative party CDU,⁵⁵⁵ but was active only a short time, because when my university studies took me to Bonn in 1983, I abandoned all political commitments for the time being.

When I started to study chemistry at the University of Bonn in the fall of 1983, Bonn, then capital of West Germany, was a hotbed of anti-government demonstrations mainly by leftist students. The German federal government, led by the CDU and CSU, had agreed to the stationing of Pershing middle range nuclear weapons in Germany by the U.S. armed forces and also planned a census of the German population. Both infuriated the German left, who was strongly opposed to any foreign military presence in Germany and to any governmental intrusion into the privacy of German citizens.⁵⁵⁶ I, on the other hand, took the position held by the German federal government led by the CDU/CSU, arguing *for* the census and *for* the stationing of U.S. nuclear weapons to deter the Soviets.

However, my involvement was abruptly curbed when CSU chairman Strauß engineered a one billion Deutschmark loan to communist East Germany, a deal that contradicted everything Strauß stood for, in particular, the principle that one should never do business with the totalita-

⁵⁵⁴ *Christlich Soziale Union*, Christian Social Union.

⁵⁵⁵ *Christlich Demokratische Union*, Christian Democratic Union. They actually refused to be called conservative, and rightly so, since only a minority of their members has conservative views, the majority having quite liberal views. The CDU has no section in Bavaria, where the CSU plays its role, though the Bavarian CSU is more conservative than the "Prussian" CDU.

⁵⁵⁶ Today the German government consists of those who protested against such politics in the 70s and 80s, and as was to be expected, they now do even worse: They wage war in Serbia and Afghanistan, and they are increasingly dismantling the Germans' civil rights.

rian powers of the East, unless some reciprocal benefit was forthcoming. The reciprocal benefit here, however, was only imaginary in that East Germany's communist government promised to remove the "robot" machine guns on the intra-German border, which automatically killed or maimed every German trying to pass from totalitarian East Germany to "Golden" West Germany. Subsequently, these atrocious weapons were indeed removed, but this was accompanied by the construction of a second border fence farther inland. As a result, the inner-German border became even more impenetrable. Hence, Strauß' deal did not lead to any humane relief for the East Germans, but instead stabilized East Germany's economy, thus delaying its – as we know today – unavoidable final collapse for a few more years. From today's perspective, my criticism at the time was entirely justified. But at that time, it was the opinion of a separate minority only, a minority subject to ridicule – it was a "peculiar view."

First jail experience

In October 1983, I had joined a Catholic student fraternity, founded in Königsberg (East Prussia) in the late 1800s, but relocated to Bonn after WWII. At the end of WWII, almost the entire German population of East Prussia either fled, was murdered, or expelled by the invading Soviets who divided this old German province in two parts, annexed the northern part and gave the southern part to Poland. In 1984, a "brother" of this fraternity persuaded me to accompany him on a trip to Czechoslovakia in February of that same year. This fraternity brother was a student of Catholic theology and had adopted the cause of the suppressed Catholic Church in the then still Stalinist Czechoslovakia. Also, he had acquaintances there, and his parents were from the Sudetenland, a once purely German border region of Czechia, from where most Sudeten-Germans had been expelled or murdered after WWII by the Czechs. This fraternity brother of mine believed in and fought for the rights both of the small Sudeten-German minority still living in Czechoslovakia and for the expelled Sudeten-Germans, most of whom had resettled in Bavaria and Austria after WWII.

With the knowledge and support of the Catholic Church, we attempted to smuggle theological and political books, as well as a photocopier, to a Catholic congregation in Prague. Our political literature included, for example, a Czech edition of George Orwell's *1984*, which was forbidden in the then Czechoslovakian Socialist Soviet Republic.

Although the books arrived at their destination, the photocopier was discovered at the border and my fraternity brother, another person traveling with us and myself were immediately confined to prison at Pilsen in the west of Czechoslovakia. After two weeks of nervous waiting, without any contact to the outside world, during which I was interrogated twice, I was told I could leave. My fraternity brother, however, was later sentenced to a year's imprisonment. He was forced to remain in jail for ten months until Christmas time 1984, when German Foreign Minister Hans-Dietrich Genscher intervened and managed to get him released early.

Justice, not brute force

For many others, this experience might possibly have convinced them to leave controversial topics well enough alone. For me, it was the opposite. When I find that I have been the victim of injustice, my reaction is to fight until amends are made.

It was at this time that I became familiar with the dark side of the Communist dictatorship. I swore to myself in prison, once I was set free, I would combat the evil of Communism.

During the following year and a half, I became more involved with those who had been the victim of expulsions: firstly, because my father had been expelled from the east German province Silesia, together with millions of German compatriots (after WWII, Silesia was annexed by Poland and is now its southwestern part); secondly, probably as a result of memories of the fraternity brother mentioned above; and thirdly, from a conviction that the expulsion and persecution of East Germans by the communist dictatorships of Czechoslovakia, Yugoslavia, Poland, and the USSR was one of the greatest crimes in history, a crime which ought never be forgotten, trivialized or minimized, approved or justified. Parallels with the arguments invariably made in regards to the persecution of the Jews inevitably come to mind.

First political thoughts

The year 1985 was marked by two events:

First, the so-called Engelhard⁵⁵⁷ Law was discussed and finally enacted, according to which the offense to dispute, diminish, or justify the crimes of the National Socialist regime, or any other tyrannical re-

⁵⁵⁷ Named after the then German Secretary of Justice.

gime, will be prosecuted automatically, without anybody needing to file a complaint. The original intention of those who started this discussion – the leftist Social-Democrats – was to make it easier for the legal system to prosecute “Holocaust deniers,” without the necessity of a complaint by some Jewish individual or organization. Certain segments of Germany’s semi-conservative party – especially those lobbying for the German expellees – demanded that this law should also apply to anyone minimizing or justifying the crimes of other dictatorships, for example, those who minimized or justified the criminal post-war expulsion of Germans from east Germany and eastern Europe.

In this discussion, I vigorously took sides on the wing of the conservatives often disparagingly referred to as the “steel helmet faction.” By then, I had frequently experienced that those working and arguing on behalf of the German expellees are confronted with the argument that the Germans in general and the German expellees in particular have no right to insist on their claims, even if they were supported by international law.

After all, since Germany under Hitler had wanted war and started war, and since so much guilt had accumulated as a result of the “extermination” or “intended extermination” of the Jews and Slavs, any subsequent crimes committed against Germans by the peoples of Eastern Europe must be viewed as mere recompense. One had to take this view for the sake of a peaceful life. But by so doing, crimes, when committed against Germans by non-Germans, are considered to constitute a counterbalance to German crimes against other nationals, and are thus accepted as “fair punishment.” This is common practice, it is a matter of good conduct in Germany to see it this way. But you will be sorry, should it ever enter your mind to turn this argument around and compare and counterbalance German crimes, actual or alleged, with those of other nationalities. This is, of course, *verboten!* In fact, continual reminders of German crimes, whether true or not, were and are still used to suppress any memory of crimes committed against my own people, the Germans, or to discuss justified claims resulting from the Allied crimes.

No doubts about the indisputable

Certainly, it would have been possible to try and dispute these German crimes, actual or alleged, as a means of overcoming the obstacles of discussing the crimes committed against Germans. But this course of

action was not open to me, since I could neither argue nor act against my strongly held convictions. I was a firm believer in the standard historical account of the extermination of the Jews. This approach was therefore closed to me – it did not even occur to me as a theoretical possibility. The only available way was to take the position that two wrongs do not make a right, and no good could ever come of a wrong. This applies to the National Socialist persecution of the Jews as well as to the expulsion of the Germans.

Tackling the *Zeitgeist*

The second significant event of 1985 was my joining a political party called *Republikaner* (not to be confused with the U.S. Republicans). I made contact with this party through my involvement with the youth branch of an organization of Silesian Germans. At that time, these *Republikaners* were relatively unknown and their members were thought of as conservative patriots, but not as a right-wing radicals. I discovered that this party had originated from a split with Bavaria's conservative party CSU. The reason for some members of the CSU to leave this party and form their own was dissatisfaction with the mediation of the billion Deutschmark loan to communist East Germany by CSU chairman Franz-Josef Strauß, as already mentioned. The party appeared to me as a kind of nation-wide CSU – minus the fear and trembling in the face of the Eastern bloc, and minus the marked patronage of offices and blatant corruption which was noticeable already then.

At first, I thought that this was just the party I had long been looking for, at least with respect to German national politics. However, their handling of the subject of immigrants repelled me, because as a Catholic I was very sensitive to programs or ideas that appeared to be motivated by hostility to foreigners.

An anti-fascist climb-down

The year 1986 was marked by two events as well:

First, I came to realize that the *Republikaners*, at least in the Bonn-Siegburg districts, were mostly a collection of hard-core right-wingers who had been expelled from East Germany after WWII. At the only membership meeting that I attended, it was obvious to me that they could not find anything more important to talk about than the question of whether and to what extent West Prussia was German, and whether

territorial claims to it could be asserted. This complete withdrawal from political reality, accompanied by a failure to recognize that which was politically necessary at the time the world was debating the reunion of West and East Germany, contributed to my decision to leave the party.

The most compelling reason for my decision was a recognition that the party included more than a few former members of the right-wing radical party NPD,⁵⁵⁸ with whom I wanted no contact. After a membership of half a year, I left the party in early or middle 1986.

The second event that I wish to discuss here took place in January 1986, at a convention to celebrate the 115th anniversary of the founding of the German Reich in 1871, organized by the student fraternity *Verein Deutscher Studenten* (VDSt, Association of German Students), and held in Frankfurt. It was at this convention that I first learned that the VDSt Frankfurt was a nationalistically oriented student organization. And it was after this celebration that I had a long argument with a student member of this organization who claimed to be a member of the nationalist party NPD. The subject of our argument was the extermination of the Jews. He maintained that the established description did not fit the facts, and that there were not, in reality, six million victims, but three million at most. I was appalled by this manner of argument, and will explain why.

Repulsive numbers juggling

First, there was the natural repugnance aroused by a line of argument which tended merely to diminish a few numbers, although the issue is not really the actual numbers, but the intention behind the deed. My belief at that time was that Hitler had planned to exterminate the Jews, and had done whatever had been necessary to accomplish this goal. The actual “how” and “how many” were of secondary importance.

From the student’s style of argument, it was clear that he had strong political motives for his way of thinking. He spoke of the use of the “Auschwitz bludgeon” against the political right, and in particular, against his party. His mixture of political objectives and scientific argumentation made me skeptical. I could not take his arguments at face value, because I was unable to trust him. I silently reproached him for his political involvement, believing that he was no longer willing or able to distinguish between truth and falsehood, between the justified and the unjustified.

⁵⁵⁸ *Nationaldemokratische Partei Deutschlands*, National Democratic Party of Germany.

I have forgotten his exact arguments and conclusions. Perhaps I do him an injustice, but I still retain a bitter taste of his unbending, politically-motivated way of thinking. It is possible that this is merely an impression I had, because at the time, I thought of all NPD members as extremists with dishonest intentions. It is therefore possible that it wasn't the NPD member who had a distorted view of things, but rather, that I saw him distortedly by my own prejudices. That question will never be answered.

Politics prevents doubt

What can one say today about that event? Although I had dealt with this Holocaust “denier” and was well aware of the reality of the political misuse of the “Auschwitz bludgeon” against the political right or right-wing oriented people, this did not lead to my doubting the truth of the usual historical version of the National Socialist persecution of the Jews. The reason was that I could not, and cannot, take seriously any position maintained for obviously political reasons.

In the years that followed, I devoted myself chiefly to my studies; in 1986, I had entered the demanding graduate phase of my studies with subsequent preparation for the *Diplom* examination.⁵⁵⁹ During this period, I abandoned all political activity and withdrew from my work with German refugee organizations and with my student fraternity. This was due not only to my academic work load, but also because I had had my fill of nonsense and no longer cared about activities which were partially unrealistic and mostly useless.

Turks into the “gas chamber”?

The pressure let up in the year 1989, as I had just completed my *Diplom* examinations and therefore enjoyed some free time for different intellectual pursuits. The same year was also marked by two significant events.

The first event was the elections for the Berlin Chamber of Deputies, during which the *Republikaners* gained their famous (or infamous) entry into the city's parliament. Like most people, I was completely surprised by this outcome, since I had lost almost all contact with this party. But, in contrast to most other people, I had some idea of what the *Republikaners* were, and were not. The horrifying media witch-hunt

⁵⁵⁹ Regarding its difficulty, the German *Diplom* is almost an equivalent to an Anglo-Saxon PhD.

against this party immediately following the electoral success infuriated me. Characteristic of this witch-hunt was the question posed by a journalist on election eve to Bernhard Andres, then party chairman in Berlin, as to whether the *Republikaners* wished to do to the Turks what Hitler had done to the Jews. That was when things turned sour. It was clear to me in the flash of a moment's insight that I would rejoin the *Republikaner* out of pure defiance and democratic solidarity, even if I was displeased by some things about this party. One could take or leave a few isolated party positions as one wished. As long as the party was in compliance with the German constitution, it was entitled to treatment on the basis of equality.

Of course, nothing that has happened since then bears any resemblance to democracy. Party meetings were regularly harassed or prohibited, although Germans were guaranteed the freedom of assembly as a "basic right." The print and electronic news media were instructed to report nothing but negative information about this party, a fact not in conformity with the standards of ethics and the legal duty of the publicly-funded news media to report the news with objectivity.

The establishment parties placed the *Republikaners* beyond the pale of democracy and constitutional politics. It was therefore those establishment parties who had violated the constitutional right of the *Republikaners* to equal treatment, as well as to the freedoms of expression and assembly.

Professional disbarment due to loyalty to the constitution

One of my close friends, a long-time member of Germany's semi-conservative party CDU, had recently completed his studies in civil administration and was assigned to the city government of a large city in Saxony during his period of practical training. He then received orders from his supervisor, a CDU member, to prohibit the planned regional party convention of the *Republikaners*. Since it was his specific duty as a civil servant to respect the provisions of the German constitution, he refused to obey these orders on the grounds that the *Republikaners* were a legally constituted party, the unconstitutionality or undemocratic nature of which has remained unproven. Therefore, in accordance with the principle of equal treatment for political parties, as well as with the rights of free assembly and a respect for the duty of

democratic parties to hold regular meetings of their members, their party convention could not lawfully be prohibited.

The consequence of this disobedience was that my friend was told that he would not be able to complete his period of practical training. To avoid forced termination during this period, my friend agreed to a termination agreement to become effective subsequent to this training. His concomitant attempt to fight the agreement in the Labor Court naturally failed. In Germany, those who defend the constitution are dumped on the street, while those who continually violate the constitution enjoy offices and power while the media cheer them on.

“Reprehensible” German unity

I need to discuss another reason for my rejoining the *Republikaners* in 1989. My belief that one should hold fast to the unity of the German Fatherland has never changed. The left-wing German party SPD⁵⁶⁰ had abandoned the goal of reunification in the mid-70s, while the left-wing radical GRÜNE (Greens) had always supported the division of Germany into two independent states. The small liberal party FDP⁵⁶¹ followed in the mid-80s in their support for two independent German states, and towards the end of the 80s, even within the semi-conservative CDU calls to put off the German reunification forever became louder and louder. In this connection (I believe it was in 1987), I remember the commentary of Dr. Helmut Kohl, then leader of the CDU and German chancellor, on a position paper of a certain CDU Member of Parliament, Bernhard Friedmann, concerning German reunification, which Dr. Kohl described as “blooming nonsense.” After the political sea-change of 1983, when the semi-conservative/liberal CDU/FDP coalition replaced that of the socialist/liberal SPD/FDP government of the decade before, the new government dissolved all governmental departments in charge of administrative preparations for a German reunification. The left wing of the CDU, under Rita Süßmuth, Heiner Geißler and Norbert Blüm, campaigned openly for dual statehood. In the summer of 1989, the Federal Council of the CDU youth organization *Junge Union* (Young Union) took the initiative to recommend the deletion of the political goal of German reunification from the party program of the CDU— just a few months before the Berlin Wall fell and Germany actually was reunified!

⁵⁶⁰ *Sozialdemokratische Partei Deutschlands*, Socialdemocratic Party of Germany.

⁵⁶¹ *Freie Demokratische Partei*, Free Democratic Party.

Now that Germany is reunited, a devastating judgment must be passed upon all the established political parties with regards to their political competence. From the standpoint of the present, the *Republikaners* were the only party, of those involved at the time, with a correct estimation of the historical and political forces, even if they were subsequently booted out by the turncoats of reunification. I was in the party because all the other parties had abandoned, or were about to abandon in an absolutely unconstitutional manner, the principle of reunification, a principle laid down in the preamble to the German constitution.

It is significant also that my membership in the *Republikaners*, which ended in the summer of 1991, was later used by the District Court Stuttgart as an indicator of my political mania – in full knowledge of what I have just described. Nowadays, support for the maintenance of constitutional political principles is deemed reprehensible, if not outright illegal. Further comments are superfluous.

Ready to go into a new era...

The young people that streamed into the *Republikaner* party at that time wanted to do something for German reunification, since this was impossible in almost any other political party. Former members of the CDU, the SPD and the FDP joined, as well as people from right-wing splinter parties and many people who had never been in any party at all. It was a motley group resulting in an unholy chaos. But among us students in Frankfurt, where I completed work for my diploma thesis and later performed my compulsory military service,⁵⁶² this plate of mixed vegetables was intellectually very fruitful. In the newly founded *Republikaner* university organization, we had one former member of the liberal party FDP, one from the socialist party SPD, one from the conservative ecologist party ÖDP,⁵⁶³ three from the semi-conservative CDU, and many who were active for the first time. During this time, we were flooded with new ideas and discussed controversial issues as never before.

In this Frankfurt period, which ended in late 1990, I read nearly 200 books, mostly during my “loafer-service” in the *Bundeswehr*: I read right-wing and left-wing books, books from the middle-of-the-road, and books without any political viewpoint. It was one of the best times I

⁵⁶² In Germany, military service is compulsory for all men physically fit to do so.

⁵⁶³ *Ökologisch Demokratische Partei*, Ecological Democratic Party.

have ever experienced. It was like preparing for an intellectual break-out.

...but instead into the offside

Our interest in involvement with the *Republikaner* party disappeared due to the fact that it was extremely anti-academic, both in its ranks and leadership. We had to let ourselves be mocked and called greenhorns and academic egg-heads by other members, and the work of our high-school organization was torpedoed by the *Republikaner* leadership which led to our resignation. From 1990 onwards, the *Republikaner* party has concerned itself mostly with internal conflicts; since every initiative for constructive work was received with malicious criticism, I resigned in the summer of 1991, about nine months after my relocation to Stuttgart in order to start my PhD studies.

A concentration camp inmate...

Now back to the question of how I became a revisionist. Certainly in the beginning of my second involvement with the *Republikaners*, I was repeatedly confronted with the use of the “Auschwitz bludgeon” used against both “my” party and myself. I have mentioned above the scandalous question of the journalist after the Berlin election, a question which was used continually to suggest that the *Republikaners* – after they had seized power – intended to “gas” the Turkish immigrants residing in Germany. Wouldn’t it have been easy to have introduced the idea of disputing the Holocaust at such a time?

I had a chance to do this in the spring of 1989, when one of my friends, who had left the “liberal” FDP shortly before to join the *Republikaners*, addressed the Holocaust issue in one of our discussions. He recommended that I read the book *Was ist Wahrheit* (“What is Truth”), by the socialist Frenchman, Professor Paul Rassinier.³⁴ This may be regarded as the first fully revisionist book ever published. It deals with the supposed extermination of the Jews from the point of view of a former member of the French Resistance who had been incarcerated by the Germans in several concentration camps during WWII.

The remarkable thing about the book is its author. Since he was interned in several concentration camps as a member of the Resistance and was a pronounced left-winger – before and after WWII, he was a French member of parliament for the leftist socialists – he could not be

accused of wanting to whitewash anything or of having any kind of political agenda. Written in a factual and balanced style, the book was easy to read; we discussed it, and that was all. I felt no need to devote myself further to the subject, either through the examination of further revisionist or establishment literature or through undertaking my own investigations. If there had ever been a political reason for an involvement with Holocaust revisionism, it would have been when I was throwing myself intensively into debating on behalf of the *Republikaners*.

...a neutral Swiss...

The cause of my interest in the Holocaust problem, beginning in the fall of 1989, came from quite another source, one that was only secondarily political and which had nothing to do with the *Republikaner*. In the fall of 1989, I bought the book *Der Nasenring. Im Dickicht der Vergangenheitsbewältigung* (“The Nose Ring – In the Thicket of Coming to Terms with the Past”) by the Swiss political scientist Dr. Armin Mohler.⁵⁶⁴ I had already received an earlier edition of this book as a gift from my mother in the mid-1980s. This earlier edition was the result of an assignment given to Mohler by a semi-official institute of West Germany. Mohler was asked to study how and when German attempts to come to terms with their past – originally a purely moral impetus – had become a weapon in day-to-day political discussion and intrigues.

That “coming to terms with the past” could lend itself to misuse for dirty schemes is obvious. From my own experience, I can think of three notable cases, where prominent German figures were driven out of office and their reputation destroyed by political and media smear campaigns. In such cases, the media and/or competing colleagues either use (allegedly) “brown spots” in the CV of the attacked individuals’ WWII history, or they distort and/or instrumentalize “politically incorrect” statements certain individuals made in public or private about Germany’s WWII past.⁵⁶⁵ Whatever the CV or the statements about the past of the victims of these campaigns are; the treatment which they receive by colleagues and the media must arouse the suspicion that the German past is being used today as a weapon of political intrigue against undesirables in one’s own political party, in other parties, or in general against any unwelcome professional competitor.

⁵⁶⁴ Heitz & Höffkes, Essen 1989.

⁵⁶⁵ The names of those persons are: Hans Filbinger, Philipp Jenninger, and Werner Höfer.

The question of how true the historical picture is that hides behind the “coming to terms with the past” Mohler handled only peripherally in this early edition of his book. His new book, which I read in the fall of 1989, goes into this question very thoroughly and thereby naturally brings up the question of the validity of historical revisionism – something which first became clear to me while reading the book.

That I got hold of this book was due not so much to its contents, which I previously knew nothing about, but more to my interest in the analyses of a Swiss political scientist, someone writing from what I considered to be a neutral position.

...and an apolitical American...

This Swiss author also reported about a study on the alleged “gas chambers” at the Auschwitz concentration camp. This study, said Mohler, had been prepared by an American expert for execution technologies, who had come to the conclusion that there had never been any gassings with poison gas in Auschwitz. One of his main arguments was the absence of traces of the poison gas supposedly used in the walls of those locations identified as homicidal “gas chambers.” Since this was a quite intriguing argument, I decided to order a copy of this study, for which Dr. Mohler even provided an address in his book. Thus were the factors brought together that I needed to compel me to get to the bottom of the problem: the report of an author I held to be politically neutral of a study by an apolitical non-partisan American on a discipline in which I had recently completed my diploma examination: Chemistry.

...enabled me to doubt

At that point, I was ready to put to the test my hitherto held opinion on the correctness of the established Holocaust dogma, because I had been presented with arguments from politically neutral persons that I could examine by means of my technical skill.

In late summer 1989, I received an English copy of the so-called *Leuchter Report*, which I have just mentioned, and I read and translated it into German immediately. But the report did not convince me entirely, because it was inexact at points and contained sloppy errors, as I described extensively in a letter to the editor published in the small right-wing monthly newspaper *Junge Freiheit* in 1990. But the *Leuchter Report* had embedded the thorn of doubt in my heart. I must now ex-

plain what that meant, since therein lies the real reason for my involvement.

Would only morons doubt?

It is generally known that none of the world's religions reproaches its adherents for doubting the faith. Religion teaches us that to doubt is human, and therefore acceptable. One who doubts is not guilty as a result.

After reading the *Leuchter Report*, I began to doubt whether the historically accepted view of the events of the Holocaust was correct. I nevertheless felt guilty, because in western societies we are imbued with our mother's milk that the history of the Holocaust is the purest truth, and those who doubt or deny this are evil or insane: extremists, National Socialists, Jew-haters, ethnic persecutors, weak-minded, morons, idiots, fruitcakes, cranks, crooks, anti-Semites, and so forth.

Yet, through a purely chemical argument, the thorn of doubt had been deeply embedded and I could only get rid of it by plucking it out or trying to forget it. I doubted, and felt guilty for doubting; yet I knew that it is not right to feel guilty for doubting.

From pole star to shooting star

Religions expect their adherents to believe in certain dogmas, but they do not demand doubters to feel guilty. At least the same must apply to science, where doubters should not be expected to feel guilty either. Here I was confronted with chemical-historical questions, and ideally speaking, science knows no dogmas, knows no compulsion to obedience, and no punishments for those who contradict the prevalent paradigm.

I therefore asked myself, why do western societies guard the Holocaust dogma closer than any religion does its own dogmas? The reason is certainly that western societies, and in particular German society, regards the Holocaust as one of their moral foundations. This I have explained elsewhere, in the book *Dissecting the Holocaust*.⁵⁶⁶ The German elites almost uniformly maintain that the health and wealth of the German Republic depend on the observance of the current official description of the Holocaust. In the German Republic, we are raised

⁵⁶⁶ 2nd edition, Theses & Dissertations Press, Chicago, IL, 2003, pp. 49-53.

with the conviction that the Holocaust is the moral pole star of our world-view, with respect to which everything else must be oriented.

That was my own unconscious belief until I began to question the standard historical version of the Holocaust. When these doubts surfaced, I was confronted with the possibility that the pole star might turn out to be only a meteor, that everything which had been held as fundamental truth may in reality be false.

Motivations

Here then are the reasons I have dedicated myself to revisionism:

1. Because of my upbringing, I felt bad merely for doubting. I knew something was wrong with a society when it instills guilt-feelings in its members simply because they dissent. The Holocaust is the one area, and almost the only area, where one is admonished to accept facts blindly; not to think critically. But we are taught to question practically everything else, even that which is kept in high regard, such as the reality of God, or sexual intimacy. We are primed to be docile subjects and kept fearful of any transgressions with respect to the Holocaust. That angered me then and it angers me still.
2. Because of my doubts, my entire outlook on life became unstable. I was no longer certain what was correct or incorrect, who lied and who told the truth. The eternal conflict of good and evil was revived in me. The question where the truth could be found concerning the Holocaust was so important, that I knew I could only recover my peace of mind by finding out for myself, personally, where the truth lay. I wanted to rid myself of uncertainty one way or the other.
3. There is no scientific area in which those who hold dissident opinions are persecuted more mercilessly by the "ruling order" than that of revisionism. That is probably why most people don't want to touch it, and most avoid it by convincing themselves that the subject is not relevant to current problems. But for me, this draconian persecution is the best proof there is that this is a crucial subject, because the powers that be regard it as most important that nobody touches this taboo. Comprehensive and critical research in this area is therefore very important for scientific, political and social reasons.⁵⁶⁷

⁵⁶⁷ See also my paper "Wissenschaft und ethische Verantwortung," in Andreas Molau (ed.), *Opposition für Deutschland*, Druffel-Verlag, Berg am Starnberger See 1995, pp. 260-288.

4. The treatment of revisionism and its proponents in areas of science, journalism, politics and law is a scandal worldwide – it demands redress.

Almost stopped...

Up to the beginning of my PhD studies in the fall of 1990, I had read only two books on the subject: Wilhelm Stäglich's *The Auschwitz Myth*⁴⁵ and the book by Kogon and others entitled *Nazi Mass Murder*.⁴⁶

After reading these books I collected information on the so-called Zündel trial in order to find out what arguments had been made there. I had discovered in winter 1989/1990 that Zündel, who had commissioned the *Leuchter Report*, was an admirer of Adolf Hitler. This revelation had the equivalent effect of a kick in the stomach, because now I had to deal with the possibility that the *Leuchter Report* was not the independent report of an apolitical American technician, but merely the instrument of a German-Canadian Neo-Nazi. But such considerations could not remove the points made by Leuchter and therefore could not remove my doubts about the historical picture.

In other words, I fully realized that a fact-oriented argument remains a fact-oriented argument – and needs to be treated as such by the examining scientist – even if it came from somebody who stated the facts for political reasons.

...but then getting into gear

I began my own research into this area at the beginning of 1991, at first out of pure personal curiosity regarding the question whether the pigment Iron Blue that developed in the walls of the buildings, where gassings with hydrogen cyanide from Zyklon B allegedly had taken place, was sufficiently stable to still be there today. After that had been proved, I concentrated on the question if, when, how, and under what circumstances this pigment could develop in walls of different compositions.

A revisionist had read my letter to the editor of *Junge Freiheit* in 1990, mentioned above, and after a phone conversation, he sent me a list of addresses of persons and organizations – almost all of them unknown to me.

After I had sent out my first research results in spring 1991 to this list, I was contacted by one person on that list, a friend of ret. Major

General Otto Ernst Remer, a retired Wehrmacht officer. At that time, Remer was engaged in publishing political pamphlets, some of which made quite blunt revisionist statements, which had led to several criminal prosecutions against him. Because of this, his friend and the Düsseldorf lawyer Hajo Herrmann, a well-known former *Luftwaffe* fighter pilot who was now Remer's defense attorney, were looking for an expert to support Remer's revisionist claims.

At that time, it even appeared to be possible for me to work jointly with the *Institut für Zeitgeschichte* (Institute for Contemporary History), an official German left-wing historical institute, whose address was on that list as well. However, they never responded to my letters, apparently because they were not interested in the technical-scientific side of the problem.

In summer 1991, I decided to leave the *Republikaner* party. I have already given the reasons for my decision. An additional and decisive motivation was that I did not want my involvement with revisionism to be interpreted politically because of my membership of a party or that my scientific activity in this controversial area would conflict with the political goals or principles of any party.

Sheer horror...

I should mention another reason that may be helpful toward understanding my involvement. Until my first trip to Auschwitz-Birkenau, I had had no exact idea of the condition of the camp's former crematoria, in which the alleged "gas chambers" were located, so I had no idea whether it would actually be useful to undertake technical or chemical research. Before my first trip, I had thoroughly prepared myself as to what I might expect with respect to the material remains at, for example, "gas chambers," if the generally accepted reports of the mass gassings in Birkenau were correct. It was clear to me, for example, if one was to believe the eyewitnesses, that the roofs of the morgues of Crematoria II and III should show three or four holes through which Zyklon B was to have been thrown into the room.

On August 16, 1991, I stood on the roof of Morgue 1 of Crematoria II at Birkenau. This location is commonly regarded as the "gas chamber" where the most mass-murders of the Third Reich are said to have taken place, a roof which was in various stages of collapse and yet still held together and partially rested on supporting columns; a roof in which I could find no trace of these holes, so that I asked myself wheth-

er I lived in a world of madmen. I found myself horribly duped by a judiciary which had never thought it necessary to make any special technical examinations of the alleged crime scene. I had been lied to by all the politicians of the world who to date had failed to assemble even the most minuscule investigation commission. I had been deceived by the innumerable “Holocaust historians” who to date had not deemed it necessary to make any investigation of the camps of Auschwitz or elsewhere, examinations which paleontologists and historians of antiquity have undertaken on the sites of ruins and other remains of ancient settlements. And I felt betrayed by the natural scientists and engineers world-over who swallowed any and every story whatsoever from the “eyewitnesses” without so much as a murmur that the material remains, the supposed crime scenes, and the eyewitness testimony itself should be subjected to some rudimentary scrutiny.

...leads to the collapse of a world-view

On this 16th of August, 1991, my world-view collapsed and I swore to do whatever necessary to advance clarification to this complex of questions. I will only abandon my position when my doubts are confirmed or rejected through convincing scientific arguments in a fair scientific discourse. Use of force will never change this position. On the contrary: it fortifies my conviction that I am right, because only he who lacks arguments must use force. And since I have been chased all over the world ever since by all sorts of government with brute force, I now know that I must be right.

The Eros of Cognition

In time, a further motivation was added to those mentioned above, namely what I call the “Eros of Cognition.” Whoever calls himself a scientist and has not experienced this, is not, in my opinion, a real scientist. The excitement of taking part in decisive scientific research and discoveries, to push things forward which one knows are new and even revolutionary, the consciousness of standing at the forefront and helping direct “whither the ship of discovery goes”— those are things that one must know first-hand, in order to understand what is “Eros of cognition.”

2. The Naiveté of a Young Revisionist

A Fleeting Acquaintance

In February 1991, I attended a seminar in Bad Kissingen put on by a Sudeten-German youth organization – I was not a member but had been invited. Toward the end of the seminar, I got to know another participant of about my age. He suggested that before we departed we pay a visit to Wehrmacht Generalmajor Otto Ernst Remer, who lived in that town.

Remer, I was told, was the person who had suppressed the Putsch of July 20, 1944, against Hitler, and I was told he held fast to his views of that time. Our intended visit would be a little bit like a visit to a museum containing a living political fossil. I was curious, so I agreed and off we went.

To a young man from a bourgeois home who had been fed a steady diet of anti-fascism, the living room of General and Frau Remer was creepy – Hitler busts, military decorations and all kinds of propaganda hand-outs caused a shiver to run down my back. We were given a tour of the house by Frau Remer and then treated to a showing of a video-film that portrayed the events of July 20, 1944, from Remer's viewpoint. Thus "enlightened," after an hour we left for home.⁵⁶⁸

Freedom to Witness

In summer 1991, when I was requested by Remer's attorney to prepare an expert opinion on the "gas chambers" of Auschwitz for a criminal trial against his client, I well knew the client for whom I would be acting. It was clear to me that there was a danger that Remer's political opinions and activities could rub off on "his expert witness," if the wit-

⁵⁶⁸ Moreover, the Remer couple could remember as little from this chance meeting as from the two subsequent occasions on which I met them, when I appeared as an unknown, unimportant person among a crowd. (Summer 1991: On the return from my first Auschwitz trip, I accompanied Karl Philipp on a brief visit during a reception on Remer's 80th birthday. Philipp, who was a friend of Remer, had initially contacted me for an expert report, had driven me to Auschwitz and had helped me there. Later he also assisted me with all kinds of technical and infrastructural/logistical support. Autumn 1992: Dinner of the defense team during the trial against Remer, after the court had refused to accept me as an expert witness.) The Remers came to know me personally only in January 1995, when the Stuttgart District Court went to Spain to interrogate the Remer couple as part of the trial against me on account of the commentary that Remer had added to the report without asking me. Even then in Spain they needed to ask who I was. They got to know me fairly well only after I had fled to Spain in early 1996, where I resided for four months some 50 miles west of Remer's residence in exile.

ness came to a “politically incorrect” conclusion. Why I nevertheless decided to proceed is as follows.

In a state under the rule of law, a witness, including an expert witness, cannot be punished for what he says before the court or for what he presents in writing to the court, in good conscience and to his best understanding.

Also, in civil law an expert witness is only liable if it can be proven that he violated the rules and accepted practices of his profession in producing his report and in so doing caused someone bodily or mental harm.

Therefore, when an expert witness through painstaking effort evaluates all available sources and interprets them in a technically sound manner, in good conscience and to his best understanding, then even if the conclusions of the expert report were wrong he could not be made liable for any gross negligence.

Consequently, he could defend himself at law against any civil disadvantages that resulted from the presentation of a possibly politically incorrect expert report because a witness – here an expert witness – may not be made to suffer for having testified in good conscience and to his best understanding.

Though I could see there were storms threatening to come my way, I looked on them placidly since I believed that having the law on my side gave me the upper hand.

May one publish expert opinions?

It was intended from the beginning that the expert report arising from this request of Remer’s attorney would be published. It is unusual to publish expert reports from judicial proceedings, but it does happen when the subject is of public interest. Expert reports drawn up for several trials against supposed National Socialist war criminals, for example, were later made available to a wide public for educational purposes. The Frankfurt Auschwitz Trial is a prime example of this. The expert reports produced during this trial by scientists at the *Institut für Zeitgeschichte* were later published as a collection.⁵⁶⁹

My report was ready for publication in spring 1992. The original document prepared for the court was enlarged by numerous substantial additions and the layout was improved. In summer 1992, the German publishing houses Ullstein-Langen Müller and von Hase & Köhler

⁵⁶⁹ H. Buchheim *et al.*, *Anatomie des SS-Staates*, Walter, Freiburg 1964.

showed active interest in the project. Dr. Fleißner, head of the Ullstein-Langen Müller publishers, quickly got cold feet due to the controversial nature of the theme, despite initial agreement, but von Hase & Köhler wasted no time presenting me with a signed contract. The problem with this contract was that it did not contain any specification as to when the book should appear. This meant publication could have been put off indefinitely while my hands were tied by my contractual agreement. When I pressed them to fix this they lost interest.

Waiting for the Doctor

Social and legal repression was a hint that the theme was a hot one, even when it was handled in a dry, scientific manner. On the advice of various people, I decided to postpone the publication of the document by a politically right-leaning publisher until after I had received my PhD degree.

In the European right-wing scene, the appearance of my report was awaited with increasing impatience throughout 1992; it was expected that my report would contribute decisively to a breakthrough of historical revisionism.

Various people began to prepare openly for the coming publication. I regarded these activities with mixed feelings and often needed to point out that my doctorate would not be properly completed until many months hence.

At the beginning of 1992, I reckoned that I could be in possession of the much-desired degree in the fall. Because of the workload of my doctoral supervisor Prof. von Schnering, however, I extended this period several times. I ended up waiting five more months to February, 1993, until Prof. von Schnering began to proofread my dissertation.

Various Distribution Activities

I came into conflict with German-Canadian revisionist Ernst Zündel in this time, because in summer 1992, without my knowledge, he gave out copies of the report as prepared for the court in February, 1992. In November, again without my knowledge, he went so far as to translate this outdated version of my report into English. Later he let it be known that he would like to be reimbursed for his translation costs to the amount of \$10,000.

I had a more pleasant experience with an attorney in Austria, Dr. Herbert Schaller. In February, 1993, he asked me if he could have 100 copies of the report to distribute discreetly in Austrian high society. Up to that point, I had made a total of 50 copies of the report by photocopier and glued in color photos by hand, which was an enormous labor. I told the attorney that since my doctoral supervisor had begun to work on my dissertation, I had no time to make 100 copies for him. However, I agreed that he could make copies from the copy he had and could distribute those – on the condition that he do so as discreetly as I myself had done already without accompanying commentary and without publicity propaganda.

As far as I know, Dr. Schaller did make and distribute 100 copies in February or March, 1993. To this day, there has been no public report of his action.

Remer Acts

As fate would have it, the Austrian attorney Dr. Schaller was also one of Otto Ernst Remer's defense attorneys. Remer must have heard about the distribution of my report in Austria. Shortly thereafter, I was informed by one of Remer's friends, and without Remer's knowledge, as I found out later, concerning Remer's intention to do in Germany what his lawyer had done in Austria. According to what I was told, Remer intended to do exactly as the Austrian had done. But because Germany is more than ten times larger than Austria, Remer and his friends intended to do their distribution activity more professionally by having my expert report printed instead of photocopied. Though I knew this could put my PhD degree in jeopardy, I saw no reason to intervene. Naively I thought that Remer would stick to the rules the Austrian had followed, which were perhaps too natural to me to be pointed out specifically: the report must remain unaltered, no additional text, no publicity propaganda is to be made. As we shall see, these rules were not considered natural by Remer and his friends.

The Bull in the China Shop

In March, 1993, with a furious publicity campaign, Remer announced as a measure of self-defense that he was going to publish and distribute that piece of exculpatory evidence that he was not permitted to present to the court, because the Holocaust is assumed to be self-evident.⁵⁷⁰ Thereby Remer broke the first unconditional rule for the protection of my doctoral title, namely that there be no accompanying publicity propaganda. Thinking that this writing would only circulate in Remer's circle of supporters, I paid little attention. When I received a phone call from a journalist of a west German radio station, informing me that some of those advertising sheets had surfaced at the University of Cologne, the situation changed. Soon the management of the Fresenius Institute was on the telephone asking me what was in the report – the Fresenius Institute had analyzed the masonry samples from Auschwitz for me. They hinted that they might consider joining me in taking legal action against Remer. An hour later the institute's attorney was threatening me with legal action. Remer had become a bull in the china shop.

Between a Rock and a Hard Place

My situation was precarious. At the request of an attorney, I had prepared an expert opinion to be used in the defense of his client. The conclusion of the report was potentially capable of reducing the culpability of said client with respect to the criminality of some of his factual assertions. I intended to publish the report a few months after completing my doctoral work anyway. Now the client took the step of publishing the report at a time that was uncomfortably early and, what was worse and unexpected, with an unhealthy press campaign. Should I now take him to court after having helped him in court? Should I take him to court for doing what I intended to do myself in a few months, though

⁵⁷⁰ Chapter 244 of the German Criminal Code provides that the court may reject evidence on the grounds of "common knowledge" or complete unsuitability. This happens mostly in "Holocaust" cases, and, indeed, without examination of the submitted evidence in order to determine whether it is actually unsuitable or whether it may be able to defeat "common knowledge," which it might do if it were superior to evidence previously submitted. In trials against revisionists and also against supposed "National Socialist criminals," exculpatory evidence is de facto verboten, a classic indication of a show trial.

with a smaller or different press campaign?⁵⁷¹ After all, I had been informed in advance and did not intervene then. The only thing that had changed was Remer's public relation activities.

The Industrious Additions

As if Remer's industrious publicity campaign were not enough, in April 1993, as my expert report was handed out for the first time, I learned that a one-page foreword and a five-page appendix consisting of a description of Remer's criminal trial had been added to my report.⁵⁷² I was not the least bit interested in whether or not the added commentary was criminally relevant. I only glanced at the foreword and took no notice of the trial description added after the end of my report. I was aggravated in that Remer had expanded and thus altered the text without authorization. Never mind what was in the commentary – it did not have my approval and that was aggravating enough. But now that this report of mine had been printed, what could I do about it? I thought that it was obvious that I could not be held responsible for something whose addition to my report I had had no knowledge of, not to mention that I had neither given my agreement to it nor had I participated in its preparation. So why should I care whether the content of Remer's commentary was criminal? As a matter of fact, I basically ignored Remer's comments. So it happened that I perused Remer's commentary for the first time at the end of 1994, fully one and three quarters of a year afterward, after my own criminal indictment because of that commentary.

The Hot Potato

In any case, in early 1993, I was concerned only about my doctoral work. This also was due to a passage in Remer's appendix, which my doctoral supervisor held under my nose shortly after he – as all professors of chemistry in Germany – had received his copy. In the above-mentioned report on Remer's criminal trial, I had been mentioned in connection with the Max Planck Institute for Solid State Research in Stuttgart. Though I was preparing my PhD thesis in theoretical crystallography at this institute, my research about the "gas chambers" of Auschwitz and my subsequent activities as an expert witness had nothing to do with this governmental research institute. It was my private

⁵⁷¹ My hesitation in taking legal measures against Remer was later used by the court as an indication of my complicity with him.

⁵⁷² See Part II, chapter 5.1., for the text Remer had added.

activity. However, the fact that I was referred to in Remer's appendix as an "expert from the Max Planck Institute" had the consequence that the German news media and scientific, legal, and political circles unleashed a storm over the Max Planck Institute and demanded to have my head. At the insistence of the institute, I consulted an attorney specializing in copyright law. He, however, made it clear to me that no "serious" attorney would touch such a hot potato, both from conviction and for the sake of his reputation. Also, it was not clear whether I had any ground of action against Remer, since the copyright had probably gone to him because he had ordered and paid for the report as I had admitted, although I was only paid expenses.

The question of the copyright to the report has never been cleared up. The Remers always held the position that they have the copyright to the report because they paid for it, and that they can do with it as they please. There was a contractual agreement set to paper, but unfortunately I lost my copy as a result of house searches and changes of abode, and the Remers could not find their copy after their flight to Spain, so that the actual contents of the document cannot be determined. I remember only that I was promised to be reimbursed for expenses that I incurred through the production of the report, and that in turn I was supposed to publish my expert report, but no time limit was given for that. The copyright was not discussed.

Also, the Remers have silently accepted that since June 1993, without consulting them, I have on my own determined where, when, and how my report is to appear in each of several languages – German, English, French and Dutch.

Thousands of Dollars – for Nothing

Left out in the rain, as it were, in mid-April 1993, I tried to divert Herr Remer. At the start of May, I finally succeeded in persuading him to curtail his distribution activities because of the reprisals I was experiencing.

Aside from any legal aspect of Remer's commentary, I would like to make a few observations. First, Remer's remarks were composed in a style that would insult any average anti-fascist citizen – and that would be about 95% of the population. One could well assume for that reason alone that most recipients of this version of the report would toss it into the wastebasket unread.

Not only that, but Remer had done something that would cause nearly all his recipients who possessed a spark of pride to consign the piece to the fire. In his foreword on the inside front cover, he attacked our leading politicians, media people, and jurists with the words, “These liars need to be driven from their sinecure fortresses.”

At the same time, Remer sent this version of my report to exactly these leading politicians, media people, and jurists, and apparently believed he could achieve some success thereby. It is certain that to send a piece of writing to someone in which he is criticized and threatened is a useless exercise. Remer’s defense action must have cost him thousands of dollars – all for nothing.

In the Talons of Justice

After I had stopped Remer’s defense action, the legal process ran its course. It was my thinking that no one could touch me for something I had not done. But the State’s Attorney had to investigate, since many of those to whom Remer had sent his copies had filed criminal complaints against him and against me: the German Society of Chemists, many state attorneys and chief state attorneys, judges and presidents of district courts and federal courts, left-wing party representatives from various parliaments, professors of various disciplines from universities throughout Germany, and on and on and on. Not to mention that there were continual inquiries from Tel Aviv that persist even today.

Strangely, the state attorneys were active only against me. They made inquiries about Remer, but saw no need to search his house. With respect to Remer, they were satisfied to push papers around. With respect to me, over the following years they searched my house three times and took away everything that was not nailed down. Apparently, German justice did not consider Remer to be dangerous. The Remer problem, they probably thought, would solve itself biologically. My case, however, they decided, needed extra effort.

The End of Illusions

The trial, which lasted from the end of 1994 to the middle of 1995, destroyed what remained of my illusions about the rule of law in Germany. I have described this in Part II, chapter 4: “Flaws of the State Under the Rule of Law.” On January 19, 1996, the Federal General Attorney determined that I was to spend 14 months behind bars, not for

my report but for Remer's commentary. The Federal Supreme Court concurred with this sentence in a decision on March 7, 1996 (Ref. 1 StR 18/96). On Remer's commentary, the District Court of Stuttgart stated in passing sentence (Ref. 17 KLS 83/94, S. 115):

"Although the preface and epilogue did not explicitly accuse the Jews of fabricating the descriptions of the Holocaust for political and material benefits, in the view of the court the Remer version of the report had the purpose of suggesting this and thereby arousing hostility toward the Jews. This follows from the fact that the reader, believing the claims of the report to be correct and influenced by the tendentious comments and rhetoric, would come to the conclusion that the surviving Jews as the most important witnesses of events, surviving relatives as directly affected and Jewish researchers must have intentionally concocted false reports on the Holocaust."

According to the court, then, Remer's remarks were not punishable by themselves; only together with my report a reader so inclined could "read between the lines" and would supposedly be led to hostility toward the Jews, and that is morally indefensible because it must be clear that everyone ought to be "a friend of the Jews."

Therefore, not only was I punished for a crime I had not committed, but for one which no one had committed.

This would have made some sense, at least, if Remer had foregone his commentary and I had been sentenced for my report and not for somebody else's commentary, but that was not the case.

In Exile

On May 7, 1996, the criminal trial against me and others for the publication of the book *Grundlagen zur Zeitgeschichte*⁵⁷³ (for this, see Part II, chapter 5.2.) began before the County Court of Tübingen. The sentence that could be imposed by such a court was one to four years imprisonment. Since I had already been sentenced to 14 months of imprisonment without probation, the sentence for me this time would probably not be less than two years – also without probation. Also, the public prosecutor of Tübingen was answerable to the General Prosecutor's Office in Stuttgart, and who knows to whom they are answerable. From the beginning, the following dicta overshadowed the trial:

"The moral foundation of this republic is at stake."⁵⁷⁴

⁵⁷³ See the English translation *Dissecting the Holocaust*, *op. cit.* (note 24), pp. 563-566.

⁵⁷⁴ *Die Zeit*, Dec. 31, 1993, p. 51.

*“All democracies have a basis, a cornerstone. For France it is 1789, for Germany it is Auschwitz.”*⁵⁷⁵

In its sentence, the Tübingen County Court decided the book *Grundlagen zur Zeitgeschichte* should be withdrawn from circulation, effectively annihilated and that the author and publisher should be punished. This, after prominent German historians had submitted to the court expert opinions to the effect that the book held to scientific standards and that therefore the authors, editor, publisher, sellers, printer and purchasers were owed the right of freedom of science and the right of freedom of expression (see Part II, chapter 5.2.).⁵⁷⁶ It did not help:

“The Non-Jew Must Burn!”

Since I was the editor of the book *Grundlagen zur Zeitgeschichte*, a warrant for my arrest was issued and I fled the country. In view of all this I hope one may forgive and understand my reasons that I took my family and went into exile: After a brief stay in southern Spain in spring 1996, we moved to England a few months later. A busy young father had better things to do than breathe jail-house air.⁵⁷⁷

Hindsight is Insight

Today, nine years after these events, I know that it is precisely the serious, scientific revisionist work that the establishment considers threatening, since one cannot fight a professionally written work with cat-calls and jeers. Unlike shallow pamphlets, it must be taken seriously. Patrick Bahners stated the establishment view in the highly respected German daily *Frankfurter Allgemeine Zeitung*:⁵⁷⁸

“The state protects the freedom of science. It recognizes the scientist not by the result, but by correct form. [...] But it can be seen that the intention to agitate can be recognized not only by errors of form that separate beer hall talk from scientific undertaking. On the contrary agitation that is perfect in form is the most perfidious. [...] But for those who survived Auschwitz it can hardly be a slighting insult when an expert using phony reasoning tells him there never was a mortal danger.

Also the state is mocked here. If Deckert’s [a German revisionist] ‘Views about the Holocaust’ were correct, the Federal Republic was founded on a lie. Every presidential address, every minute of silence, every

⁵⁷⁵ German Federal Foreign Minister Joschka Fischer in *Süddeutschen Zeitung*, acc. to *Rheinischer Merkur*, April 16, 1999.

⁵⁷⁶ Ref. 4 Ls 15 Js 1535/95.

⁵⁷⁷ Unfortunately, my then wife took my two children and left me in January 1999, initiating divorce proceedings in early 2000. I got remarried to a U.S. citizen in 2004, though.

⁵⁷⁸ “Objektive Selbsterstörung,” *Frankfurter Allgemeine Zeitung*, August 15, 1994, p. 21.

history book would be a lie. When he denies the murder of Jews, he repudiates the legitimacy of the Federal Republic.”

However, Bahnners proceeds from false premises.

First, Bahnners does not make clear how an intention to agitate can be recognized, if not by errors of form. It is stated in the German constitution that science is free without restriction. Decisions of the German Federal Constitutional Court have stated that science is defined by formal rules alone and not by content. These decisions are in agreement with fundamental theoretical works on the nature of scientific knowledge. If Bahnners thinks differently, he is anti-constitutional, anti-scientific, and anti-human rights.

Secondly, there are no experts who assert that the survivors of Auschwitz were “never in mortal danger.” Bahnners warms up the calculated lie that revisionists would present Auschwitz as a vacation resort without danger to life or limb and generally characterize the National Socialist persecution of the Jews as harmless to the Jews. Either Bahnners doesn’t know what he’s talking about – in which case he should stay away from the keyboard – or he himself is agitating against others with different opinions, in which case the *Frankfurter Allgemeine Zeitung* should not allow Bahnners to soil its reputation.

Thirdly, Bahnners’ conception that the legitimacy of the Federal Republic of Germany is based on the unconditional recognition of the established version of the National Socialist persecution and extermination of the Jews is absurd and utterly false. If the Federal Republic of Germany were actually founded on this historical detail, it would be a dire weakness, because every state that bases its existence on a version of history enforced under pains and penalties must sooner or later come to grief.

Certainly, the formal foundations of the legitimacy of the German Republic are very different – human rights, civil rights, acceptance by the people of the state, international recognition, political, historical and cultural identity and continuity with preceding German states – and there is no need to accept the harsh judgment of Bahnners and some of his colleagues.

Pseudo-legal Contortions

However, it was made clear in 1996 by the Ministry of Justice of Baden-Württemberg that in the future Germany’s judicial system will adopt Bahnners’ viewpoint, namely that revisionist works of a scientific

nature constitute incitement to hatred and must therefore be burned. In its answer to a question relating to the seizure of scientific revisionist books of Grabert Verlag it stated:⁵⁷⁹

“Legal intervention is not constitutionally excluded even when it is clear that the case involves a work of science or research. Article 5, Para. 3, Cl. 1 of the Fundamental Law contains no expressed prohibition of limits. In constitutional law it is recognized that even freedoms that are granted without expressed conditions have limits. Such limits might come from the fundamental rights of third parties or from other constitutionally protected goods. In these cases there must be a comparison of the competing claims of the equally constitutionally protected interests with the purpose of optimizing these claims. There must be a particular examination of the case making use of the method of proportionality. (Decisions of the Federal Constitutional Court (BVerfGE) 67, 213, 228; 77, 240, 253; 81, 278, 292ff.; 83, 130, 143) When these constitutional requirements are met, in special cases use of appropriate measures is consistent with freedom of science or of research.”

The assertion of the minister of justice that even a scientific work can be seized when the fundamental rights of others are involved is completely false, and the decisions of the German Federal Constitutional Court cited here are misleading. It is true that no fundamental right can be guaranteed unconditionally, and when there is a conflict with other fundamental rights that an optimal compromise of interests must be found by means of the principle of proportionality. However, this limitation of fundamental rights pertaining to the freedom of science can never extend to the determination of what theses may be studied and to which conclusions one may come.

Only the means by which research is conducted is subject to limitations, since research may not employ methods that compromise the rights of others – such as experiments on humans or endangering the environment. If it is forbidden to science to formulate new theses or to attempt to refute existing theories, however controversial these attempts and their conclusions might be, or if it is forbidden to science to use certain arguments or to come to certain conclusions, or to publish scientific conclusions in order to subject them to indispensable public scrutiny and scientific criticism, then one throws the fundamental right to freedom of scientific research entirely out the window. The critical examination of standing theories and paradigms through serious attempts

⁵⁷⁹ Dr. Ulrich Goll, ref. 4104 – III/185, Sept. 23, 1996; cf. IDN, “‘Appell der 500’ vor Landtag,” *Deutschland in Geschichte und Gegenwart* 44(4) (1996), pp. 9f.; VHO, “Zur Wissenschaftsfreiheit in Deutschland,” *VffG* 1(1) (1997), pp. 34-37.

to refute them, and the publication thereof, is the heart of science, or even of human knowledge in general.⁵⁸⁰

The Consequences

The declaration of the Ministry of Justice given above is clearly unconstitutional, and one may hope that the German Federal Constitutional Court will say so at some point in the case of *Grundlagen zur Zeitgeschichte*. Of course, it is not likely to do so under present conditions, since in a similar case of Federal book-burning in the early 1980s, the German Federal Constitutional Court itself made a statement in accord with the Ministry of Justice's statement above.⁵⁸¹

Therefore one cannot avoid the conclusion that the present situation in Germany is as follows:

1. With respect to the core of the Holocaust claim – gas chambers, the National Socialists' intention to annihilate the Jews, and the carrying out of such a program – there can be only one predetermined conclusion under penalty of law.
2. The most important condition to the free pursuit of science would then be suspended, that which states: Every thesis must be subjected to the strictest attempts at refutation and must be refutable in theory and in practice. Neither may any conclusion of scientific research be prescribed nor proscribed (cf. Article 3(3) of German Basic Law).
3. The fundamental dignity of humans that sets us apart from animals lies in the fact that we do not take our sensory impressions as being identical to objective reality, but that we doubt and can resolve our doubts through intellectual activity – research. This factor of human dignity is suspended in Germany in this particular field. (cf. Article 1, of German Basic Law).

It remains an open question what one is to do with Article 20(4) of the German Basic Law which states:

“All Germans have the right of resistance to anyone who attempts to overthrow this provision if no other means avail.”

⁵⁸⁰ Cf. Karl R. Popper, *Objective Knowledge*, 4th ed., Clarendon Press, Oxford 1979, p. 24f.

⁵⁸¹ On Wilhelm Stäglich, *op. cit.* (note 45): German Federal Constitutional Court, ref., ref. 1 BvR 408f./83, reprinted in: Wigbert Grabert, *Geschichtsbetrachtung als Wagnis*, Grabert, Tübingen 1984, pp. 287ff.

3. Fleeing from England

The names of some individuals have been changed for privacy reasons.

A World Collapses

October 29 is my birthday. Due to the permanent threat of further persecution and extradition from Britain to Germany, my (first) wife left me in January 1999 with our two kids and returned to Germany, where I couldn't follow her. She couldn't cope with this lifestyle anymore. She had permanent nightmares and was very nervous, even had panic attacks. Later in 1999, she even started divorce procedures, which was totally unexpected, because we originally had agreed to try to get together again in a few years, if Britain refused to act against me. So, my 35th birthday, the first for seven years without my beloved wife and without the most gorgeous kids in the world, would at the same time be the most depressing one I ever had in my life. But, hey, there was light at the end of tunnel: my still-wife promised that she and the kids would visit me on this occasion. And my two siblings had announced a few days before that they would drop in the weekend after my birthday. So things weren't all that bad after all.

It is October 15th, 1999, and I follow my usual business. I had several orders collected over the last week, which needed to be sent off, so I decided to drive to Tony Hancock's printing company in Uckfield, which does a nice mailing service for me, and get rid of the packages. While preparing my departure, I get a phone call from Mrs. Corrine Hancock, Tony's wife, urging me to call the guys in Uckfield. For security reasons, they neither know where I live nor have my phone number. They always have to contact a third person out of any political or police focus, or Corrine, who is the only one of these people who is not and has never been into politics, but who is interested in me on a mere personal level, and therefore I consider her to be reliable. Safe is safe.

So I call the guys. I get Howard on the line, my best friend who helps me whenever he can. He collects my mail from the PO Box in Hastings, and I use his residential address for my services: bank, insurance, tax, to keep up the system's illusion that I am really there. Howard forgets to greet me. That isn't his style:

“Someone from the media is after you. The guy left a message at my place. He must have found out where you are officially registered,” he tells me. I am shocked.

“What? What did he say?”

“First, he left a message on the answering machine, asking you to call him. But then he must have decided to pop in. He left a handwritten note under my door saying that he wanted to contact you.”

“Damn. Do you have his name?”

“Yeap. A certain Hastings.”

“Hastings? In Hastings? Or is that his name?”

“That’s his name”

“That’s strange. He *claims* that this is his name. And for which station or paper is he researching?”

“The Sunday Telegraph, he claims. I got his number. You better get up here, so that we can discuss this.”

“Yes, alright, I am already on my way. Wanted to come anyway. See you.”

“See you.”

Damn. Now they tracked me down. Must be a repercussion of the Cincinnati Real History Conference from end of September. That was my first public appearance since 1994 or so, and David Irving was so reckless as to mention that I currently reside in England when he introduced me to the audience. And that was probably enough for the media to get going. Anyway, pack your stuff together boy, and get to Uckfield as quickly as you can!

So I collect my bits and pieces, jump into my car and drive up the bridle way leading from the Crowlink settlement where I live up to the main road in Friston, over the cattle grids and the speed bumps at 30 miles per hour. The shock absorbers at the front are already gone, so don’t worry now, this is urgent. Let’s hope that the cows and sheep to the left don’t jump on my car, and that none are hiding behind a shrub, getting scared to death when I rush by.

No casualties this time. And down it goes from Friston to Jevington. This road drives like a runaway train. My kids always liked the feeling in the stomach when the car almost jumped over the road waves. My wife hated it. Through the chestnut alley I drive, rushing through Jevington and further on through Filching right into Wannock, a road so narrow and curvy that any truck or bus on the other side is a guaranteed death certificate with that speed (40-50 mph). Why am I doing that? Alright, I know and love this road as no second, but I had a couple of

“almost” cases before, so why risk it! Slow down, man! You are still a father, and your kids will miss you! So I calm down a bit.

As soon as I am out on the A22 towards Uckfield, I lose patience again. Did I ever have any? They forgot to build that into my genes, I guess. Anyway, I break a couple more English traffic rules, but I am not caught, as usual. They are very lax with speed control here. I really like it.

Half an hour later at the printers in Uckfield, Howard gives me the phone number of that Mr. Hastings and repeats what that guy told him.

“He called again this morning, and I talked to him,” Howard explains.

“How long did you talk to him? And what did you tell him?”

“Well, we had a nice chat for some 20 minutes. I told him that you don’t live here and that I am just collecting...”

“What did you?”

“I told him that you don’t...”

“How dare you? I mean, I don’t want you to lie, but why the hell did you tell him anything in the first place?”

“Well I thought that is no big deal...”

“Listen, these guys aren’t stupid. They can think that if I am not there, I must be somewhere else, and then they start sniffing around again!”

“Hey, I am doing all this because I like you. I don’t have to do it and I don’t need that sort of tone.”

“Sorry. I am just excited and scared.”

“That’s alright. Well, I told him that you live in Tunbridge Wells”

“In Tunbridge Wells?”

“Yes.”

“Why?”

“It just came to my mind.”

“I used to have fine lunches in Tunbridge once a month with my friend Robert. That’s now ruined, too. Oh well. And he bought that?”

“Apparently.”

“Uhh. At least something. And the other 18 minutes of your conversation?”

“That’s about it.”

“Jesus Christ. Please, Howard, the next time, please don’t say anything to anybody. Just take messages for me, would you?”

“Alright. How did he find out about my address and your being registered there in the first place?”

“Well, I guess it is on the Internet. I entered the street address as the registrant’s address of my website with InterNic. Pretty stupid. I guess I’ll change that now.”

“That would be nice indeed. I am not eager to get more of these guys, either.”

Tony joins us in the office and warns me:

“Hi Germar. The Sunday Telegraph is just the weekend edition of the Daily Telegraph. I think you know that, don’t you?”

“Hi. No, but now I do. So that is the famous German-hating newspaper renowned for their atrocity propaganda during both wars, yes?”

“Exactly. Don’t expect fairness. You better not get involved with them.”

“Well, what am I supposed to do? He is on my track, right?”

“Yes.”

“He is going to publish something, right?”

“Yes, but don’t think you can influence what he actually writes!”

“Well, one thing’s for sure: If I don’t try, I won’t. Let me talk to him and see what he is up to. Can I use your phone? I didn’t want to use mine.”

“Yes, go ahead.”

I quickly get through to this Chris Hastings. He wants to meet me as soon as possible, since he is going to publish something on Sunday anyway. I hate this rush. I tell him that I would call him back in ten minutes, and hang up.

“And now what?” I ask Tony.

“Well, if you go, make sure he doesn’t get you in trouble.”

“How long does it take to get to Victoria from here by train?”

“It depends on when the train leaves.”

“Can we figure that out?”

“Sure, call Southern Railways. Their number is here in the Yellow Pages.”

So I do, and it turns out that I will need roughly an hour.

“I shall give him, let’s say, three hours from now, that is 3 o’clock in the afternoon, claiming that I will need that long to get there: That’ll make him think into the wrong direction. And I’ll give him a wrong platform where we will meet. And no photos!”

So it is arranged. I tell him that I will see him at platform ten, where I claim to arrive. In fact, the train I come in arrives more than an hour earlier at platform 17 or so. I nervously kill more than an hour by restlessly walking from one end of Victoria to the other, during which time

I notice that I am unshaven and wear my sweat pants. Fine setup for a star photo session, I think. I hope that he respects my wish to not be photographed, though I don't trust him. Finally, at 3 o'clock, I go to the exit of platform 10, and to my amazement I realize that trains from Tunbridge Wells arrive there. What a great shot! Someone else is waiting there, too. I approach him, but he is alienated by my approach. That wasn't the one. Some five minutes later he stands in front of me, extending his hand to greet me. A short guy, a bit stocky, perhaps my age. Well, admittedly, I take myself as a norm, and I shouldn't do it. So, he is normal, and I am tall and slender.

We agree to sit down in this uncomfortable cafeteria in Victoria, and we get ourselves something to drink. He turns out to be a year younger than I am. He says he just got the job at the *Telegraph*, and that this is his first big story. Oh dear, I think to myself, and I am going to be the fair game for it. He needs success. He needs to impress his employer. That promises to become funny.

We spend three and a half hours talking about god and the world. I tell him my entire story. He lets my words flow, only here and there asking a few simple questions. I tell him the story of my persecution, and about the deterioration of human rights in Germany in general. He allows me to go into details. I am somehow happy to have somebody from the media who listens. What can happen, really? By experiencing me the way I am and the way I argue, he must notice that I am not the evil neo-Nazi as which I am usually portrayed by the mainstream media. I hope he does. He does not even try to make any notes, strange enough. However, he appears to be a nice guy. But that is perhaps what all journalists need to be to have success. Nobody talks openly to assholes. I get some questions answered, too. He found out via the Internet that I was a registered citizen for a year in Pevensy Bay. The voters' data are publicly accessible, he explains. The current owner of the house where I used to live gave him the name of the estate agent who sold it to him, and this agent gave him the name of my former landlady. But none of them knew where I had moved. I tell Hastings repeatedly that I wouldn't tell him anything about where I live now. He understands and gives up.

No traces lead to my new residence. Well done, Germar! At least that works!

At the end he calls his girl friend to pick him up. We say good bye, and I pretend to go back to platform 10. But I make sure that he really leaves before going back to my train to Uckfield.

On Sunday evening I get another phone call from Corrine. The *Telegraph* article was out. She urges me to come to her place. So I jump into my car and drive the 40 miles westward to Hove. I am welcomed at the Hancock' residence, and Corrine gives me the newspaper article.

"Tony tried to hide that from me," she says.

"No, I didn't" he intervenes.

"Yes, you did! You took the newspaper away and hid it!"

"Would you do me the favor and let me read it first, before we start an argument?" I throw in.

The article's main purpose is to slander me as a neo-Nazi and to collect public voices to press for my extradition.

"At least he swallowed Howard's story about my living in Tunbridge," I notice. "And this picture of mine is so bad that nobody can identify me. That is good, too. Somebody must have taken it from a distant place at the very moment when Hastings and I shook hands."

Corrine is in a real bad mood. She is suspicious that her husband is trying to hide that trouble is ahead. He had done that frequently in the past, as she had told me before.

"What sort of links did you forge with right-wing extremists?" she asks me.

"Well, I guess I was too honest to Hastings," I respond. "He asked me if I had been in contact with any persons on the political right."

"And, what did you tell him?"

"The truth. I mean, that I met David Irving, this was not part of it, since I don't consider David to be part of any political movement. Irving was simply a part of my coming to the UK, and I told Hastings how and why I came here, and how David was involved in it."

In late May 1996, roughly two months after I had fled Germany to Spain, I learned that the Spaniards were about to introduce an anti-revisionist law as well. Hence, I told my wife that I would prefer to settle with the entire family in England instead of Spain, where no such laws seem to be planned. She was glad to hear that, as neither of us spoke Spanish, and Spain was culturally a bit too distant for her. So I started seeking a way out of Spain into England. David Irving, the world-renowned British historian, was the only person in the UK I knew at least remotely. I had met him in Germany in 1991 during a convention where he spoke, and at this occasion I had given him an early version of my expert report, so he knew my name. I called him from Estepona at the Costa del Sol, where I lived with friends during

that time, and he agreed to see me. He gave me a description of how to get to his place from Heathrow.

When I got to London in early June 1996, he didn't have any time for me, though, so all I did was actually baby-sit his daughter while he left that evening to see somebody. I had to stay at a cheap hotel behind Victoria Station during the three days I stayed in London, trying to figure out if I could finish my PhD in England, which I still intended then. Later, in fall 1996, while residing in Pevensey Bay, I accompanied David as a co-driver in a lorry on one of his book distribution tours through Southeast England. We had a big fight about my map-reading skills, since I led him in the wrong direction at one point, but when he took over control, he screwed up even worse, so I had to help him to get back on track. When we made it just in the nick of time to the shipping company he had an appointment with, he apologized for his bad behavior. During this tour Irving also asked me if I would agree to appear as a witness during his pending trial against Deborah Lipstadt, proving that revisionists are the victims of severe societal persecution and prosecution. He didn't want to have me as an expert witness, though, as he intended to discuss only persecution in court, but not history. I told him that I would be happy to be of service, but I never heard back from him about this matter.

"And what is this about the National Front and the British National Party?" Corrine doesn't like all these right-wing stuff. She despises it.

"I told Hastings that in 1998 I learned about a British censorship case against a guy named Nick Griffin. You know the Griffin case, don't you?"

"No, I don't know anything about these guys, and I am not even sure if I want to," Corrine rushes to declare.

"Well, Griffin had published an article in his 'Rune' magazine in which he somehow denied the Holocaust, and furthermore he was accused of inciting racial hatred against blacks. Since I was very interested in British legislation and jurisdiction about Holocaust revisionism, and what sort of 'incitement racial hatred' is considered to be a crime, I wanted to learn more about it. My own fate could depend on it. And last but not least, my historical journal is devoted to fighting censorship. Since I wanted to write about that case, I needed to get more information. I got in touch with Griffin via email. I didn't know anything about his involvement in politics. All I knew was that he was associated with the BNP. He said he had heard about my case, and he invited me to his place in Wales. That was in February 1999. My family had just left me

the month before, and in this period I had terrible nightmares about losing my kids and wife. I was a bit desperate to get in touch with other human beings and to get distracted from my misery, so I took that opportunity to get out of my loneliness. I actually had a nice stay at Griffin's house. We spoke a lot about his family and personal fate, the ethnic and language situation in Wales, and of course about Holocaust revisionism and censorship in England. It was there that I learned about his leading role in the BNP and that he was about to challenge the leader of the party. That is what I told Hastings."

"And the National Front?"⁵⁸² Corrine insists.

"Well, I cannot remember anything about that. As a matter of fact, I do not even know if I ever have been in touch with anybody from the NF. Hastings must have just added it. Or I dropped the name Martin Webster in some context."

I first met big, fat, nice and gay Martin Webster (pardon me, Martin) incidentally at Tony's printing company while he was doing some printing business there, and later again as a visitor at Tony's place. I don't know anything about his background. All I have is a faint memory that he might be or have been involved in some right-wing stuff, as many people are or were who turn up at Tony's place. I had a nice bicycle tour with Martin down to Oxford one Saturday, during which we talked about anything but politics and his inverted sexual orientation, which is no secret to anyone.

"I can't believe that you were that naïve! You shouldn't have told him anything about that. What does a bicycle tour have to do with politics?" Corrine asks. She somehow likes Martin Webster.

"I am just telling the truth! And I am not going to start lying just because of assholes like Hastings."

"It is not about lying," Tony says, "it is about being careful and staying silent where it is better to do so."

"Anyway, this is over now. I cannot undo it. I talked to Hastings for three and a half hours about human rights, censorship, persecution, and the only thing he has to say about it is 'NAZI', and how I forged links to right-wingers."

Corrine, Tony, and I agree to simply wait and see what would happen. In the meanwhile, my email box is overflowing with messages coming in from friends all over the world who received the *Telegraph* article by email. David Irving goes ballistic. He threatens that something serious will happen if the authorities touch me. I don't know what

⁵⁸² A British radical right-wing group about which I know next to nothing.

he means by that. He doesn't have any means to threaten anybody. But at least it is a nice sign of solidarity, and I appreciate that. He was not always that supportive. Apparently he fears that if they go after me, he is going to be next.

David Botsford from the Libertarian Alliance says I should take care of myself. He offers me his house as a refuge, should things get dangerous. I never met the guy, but we had a nice time working together to update and translate one of his works about historiography and censorship. We noticed during this year of co-operation that we think quite similarly. Nice to see all these guys offering their help.

In the meantime the media in Germany jump on the bandwagon and publish the *Telegraph* story: "Neo-Nazi," "Racist," "Fascist," "anti-Semite." I start hating myself for being such a devil incarnate as they portray me. How can humans be so mean to denigrate others totally without even knowing them?

My wife gets worried whether they might come and stay in the first place. She fears that I have to dive away again. I tell her:

"Don't worry. It is business as usual here. Nothing happens. This is just the blown up story of a young journalist with profile neurosis. He needed a story to impress his employer, and it is always easy success to drive a 'Nazi-sow' through town. So, this time I am the sow, but I think things will calm down quickly."

Though it is the end of October, the weather is still pretty nice. This summer was extremely warm and dry, and it seems as if it doesn't want to end. Sunshine still dominates. I have my daily 15 mile bicycle ride through juicy pastures full of cows and sheep, enjoying the most beautiful views over England's most scenic costal area in the South Downs, the Seven Sisters. Each time I try to improve my personal record, and I am proud to have reduced the time I need from an initial 65 minutes down to 45 minutes. Each time I do this tour, I feel great. Unfortunately, on Thursday before my family arrives, I get a flat tire, and so I cannot ride until this is repaired. Since I don't want to lose time while my family is there, I postpone it until afterwards. Little did I know then that this would be the last time I would have this absolutely fantastic bicycle tour, and that I would miss this experience of nature, landscape, and my own physical strength most of all.⁵⁸³

Anyway, on Friday I pick up my family from Heathrow airport. We have a wonderful time together. On Saturday, my birthday, we visit

⁵⁸³ Until I got the chance to return to the same place in summer 2009, doing the same, well, similar tour almost every day for another year.

Hastings Castle and the Smugglers' Cave. The kids are in heaven, and so is daddy. We all spend the night together in my gigantic imperial bed, and no night can be more relaxing than those where I can hold my daughter's and son's hand while they fall asleep. Or is it the other way around? Who cares...

On Sunday morning I get another distress call from Corrine:

"They have another story about you in the *Telegraph*. You need to see this. It's getting serious now. Get here as quickly as you can. Rush, rush!" she urges me. She scares me.

I tell my wife, and her jaw drops down. Now it is about reacting quickly. She says that I can drop her and the kids off at Schumacher's, a German family and friends of ours living a few miles away in Stone Cross. No need for me to visit them with my family. I agree. So we pack our stuff, I drop them off at Schumacher's and I drive down to Hancock's place. The atmosphere in Hancock's house is icy. No nice welcome, no smiles, no hugs as I usually get. They show me the article, and I start to read:⁵⁸⁴

"Germany pursues Rudolf extradition"

I cannot swallow anymore.

"A FUGITIVE from justice and traced to Britain by The Telegraph is now facing the threat of extradition."

Senior officials at the German embassy in London have confirmed that moves are underway to have Gernar Rudolf returned to Germany..."

And so it goes on. I knew since 1997 that things were critical, since I had been sentenced for something that – strictly formally speaking – does exist as an offense in Britain, too. A lawyer told me as early as 1997 that things didn't look too good for me. I simply hoped that Britain, with its tradition of free speech and anti-German politics, wouldn't bend to German orders. I was wrong.

"So what?" I ask Tony.

"We should plan ahead," he replies.

"I figure that they are searching for me, if not now, then tomorrow or in a week or so."

"It doesn't look good. First of all you need to get out of your place immediately. You need an apartment at a place where nobody knows you," Tony suggests.

"I don't think that they react that quickly. I live there under a different identity. It will take them months to figure that out, if they succeed

⁵⁸⁴ This article and other documents connected to my persecution are posted on at www.germarrudolf.com/persecute/docs/index.html

at all. After all, I haven't committed a single crime in this country. They have more important things to do than hunting ghosts."

"And what if the estate agent remembers you, or if they start showing pictures of you in the media and asking the population to help searching you? Or if they tap phone lines and your Internet server? If they really want to find you, they will find you," Tony objects.

"This is only a worst case scenario. I don't think I am that important to them," I try to calm him down.

"Germar, we can help you out of this. But, Germar, look me in the eyes," Corrine says. There she goes again, I think.

"You know that I like you as a person," she continues. "I am going to offer you my help, but I need to be sure that you don't lie to me. Look into my eyes! – Alright. I asked you that before, and I ask you again: Have you ever been involved in any neo-Nazi stuff?"

"I told you that before. No, I haven't," I reply.

"Can you swear that you didn't?" she insists.

"Yes I can," I confirm, "and I do it herewith again. You know the story. You know why I am in trouble. It is about the comments that Wolfgang added to my report about which he didn't inform me. And even these comments weren't Nazi. They were just emotional, uncontrolled and stupid. All the stuff that I published was strictly scientific."

"I can't read German, so I have to trust you," Corrine responds. "I hate this Nazi pig Wolfgang. He destroyed your life, and he got us in trouble before."⁵⁸⁵

"It isn't that easy," I object.

"Yes it is. Everybody makes mistakes, but in contrast to you he never apologized. He just blames it on others and gets mad if you confront him about his misbehaviors, bad manners, and mistakes."

"What does this have to do with our problem," Tony interferes.

"A lot, because Wolfgang is our problem here. Listen, Germar! Should I ever find out that you lied to me, that you were indeed involved in any Nazi stuff, I shall not hesitate to give all the information I have about you to the police. Do you hear me? – Now, if you are right, and I hope and believe you are, than you deserve our help. You know that I like you. You are not one of these Nazi bastards with whom Tony associates. So I'll help you. I'll risk all I have to get you out of this

⁵⁸⁵ I quote Corrine using the words she actually spoke, and at the same time I distance myself from her in this regard. Wolfgang did not deserve such words. It is apparently a result of bad behavior on Corrine's part. I apologize to Wolfgang that I did not defend his reputation during this exchange by starting a fight with Corrine. The only thing that was on my mind at that time was to save my own skin.

mess. I'll lie for you the dirtiest lies you've ever heard. Look into my eyes! If *you* lied to me, you are going to be in trouble, I promise you!"

That is Corrine live. It took me two years to figure out that this sort of behavior is her way of expressing positive sentiments for other people. Tony is a very indulgent guy. Even though his wife is frequently swearing at him, he just stands there and smiles. I wonder what he thinks during such moments.

"You can sleep here tonight." Corrine offers.

"Alright. Thank you. But I need to get back to my place, spend the rest of the day with my kids, make an arrangement with my wife for tomorrow to bring her and the kids to the airport, and get some important documents and my computer. So I'll be back in the evening, or so. Is that alright?"

"Ok. We'll be here waiting for you."

"Alright. Thanks. Bye."

"Bye."

I get into my car and sit there silently for a moment, trying to recover from Corrine's sermon. Then I drive back home in order to get my toilet bag, pyjamas, sleeping bag, my computer and several other important things. When approaching the parking lot at the top of the hill on my way down home, however, I see a blue BMW parked there senselessly with two middle-aged gentlemen sitting in it, looking around. As soon as I pass, they start their car and follow. I panic and drive down the paved way riddled with speed-pumps at 40 miles per hour. My poor Renault Clio. They don't follow that quickly. I quickly get to my place, collect the most important stuff, and drive back. I cannot see their car anywhere. Perhaps I am only paranoid.

I pick up my family at Schumachers', and we spend the rest of the afternoon at Fort Fun in Eastbourne, which is an indoor playground. I tell my wife about the BMW, and she asks if it wouldn't be better if she and the kids drove back in a taxi, but I insist in being their chauffeur. I try to forget the circumstances of my current existence. At Fort Fun we meet former neighbors from our time together in East Dean, including a former girlfriend of my daughter Tamara. The kids have fun together. Tamara drops back into her now broken English. Just one year ago she was perfectly bilingual. Merely ten months in Germany, and most of it is gone. Kay, my son, has forgotten almost everything. He was not even three years old when his mother brought him to Germany. He doesn't understand a word of English. But Tamara remembers quickly, including the nice East Sussex accent. "Noi" they say for no, exactly the same

as the Swabian do, the south-western German region where my kids grow up now. How quickly they learn, forget, and remember languages! And while the children play, the parents pretend that nothing had happened...

Around dinner time I drive the family back to Crowlink, telling the kids that I cannot stay with them tonight. This time my wife has to get them their dinner and bring them to bed. She is used to it from Germany, but nevertheless she is a bit disappointed, but worries about me predominate. I hope the kids don't ask where daddy is this night. Didn't they come all these hundreds of miles to listen to his bedtime stories and to fall asleep with him? It hurts to even think about disappointing the kids – and me, admittedly.

As soon as the kids have closed the car door, I drive back to Uckfield. I realize only after my arrival that I forgot my wallet. Damn, the most important thing. So back I drive. The weather has adjusted to the situation. A strong wind blows from the west. Even though it is dark, I don't dare to drive down the normal way to my place. Who knows who is waiting there for me. So I drive down a different road, park my car at the end of a bridle way at Birling Gap, and walk over pastures, approaching my place from the rear. The wind is so strong that on top of the three hills of the famous Seven Sisters which I have to pass on my way, I have to bend all the way over in order to keep my balance. White balls of sea spume the size of a fist are blown up the cliffs and all over the Downs. What a perfect adaptation of weather to mood!

In the little valley into which Crowlink is nestled everything is peaceful, though. I knock on the patio door, and after a while my wife opens. I ask her about the kids, and she says that everything is fine. They are asleep already. They weren't too happy that I wasn't there, but they didn't seem to be upset about it. I tell her about the wallet. She laughs.

“If your head weren't attached to your neck, you would forget that one, too, wouldn't you?”

I smile and give her a kiss on her cheek. We agree upon a time when I would pick up her and the kids the next morning, as her flight leaves around lunch time. I tell her that she should have everything ready to be dumped into the trunk so that we can make a blitz start. My instructions, through which a lot of nervousness and anxiety shines through, makes her feel uneasy, too.

“Shouldn't I rather take a taxi bringing us to a meeting point where no one expects us?”

“I don’t think that there is any real danger,” I try to explain. “I just want to do everything to minimize risks. That’s all. So don’t worry. It’ll work out.”

We give each other a long-lasting hug.

“Take good care of yourself.”

My wife’s voice is filled with sorrow.

I leave again through the patio, and while climbing over the fence, get stuck with my black jeans on a rusty nail. Rrrrutssshhhh. That was it! No blood at least, just fabrics. Now that I have to keep all my penies together, I start wrecking my clothes. Great!

Back I walk over the pastures to my car, and swiftly I drive to Uckfield. Somehow, I am not too happy to sleep at Tony’s place. Wouldn’t the police find out that his printing company plays a major role in my business affairs? And wouldn’t they look at his place first to find information about my whereabouts? I cannot but think that I am coming from rain to drain.

I park my car around seven corners. I am sure they know my car’s number plate and will look for it. It shouldn’t be close to Tony’s house. So I have to walk quite a bit to get there, carrying my important papers, the overnight bag, and my pyjamas, but I leave my computer in the car (which makes me nervous). Corrine welcomes me and leads me into the attic where they have a sofa that can be transformed into a kind of bed. I hate these pieces of furniture. In most cases I have some back pain the next morning after having slept on such devices. And the blanket and pillows I get look crappy, too. But I am in no position to complain about such unimportant things. The first thing I do is find out where I could possibly hide or escape unnoticed, should Police come: Out of the roof window opening to the back yard one can easily climb onto the roof and from there down into the yard. I really am paranoid. But only the paranoid survive...

The night passes by without any particular events, except that I don’t sleep very well. I get up very early, still before dawn. Tony is just about to leave for work. He says he is going to listen around if somebody can hide me for a while until I can leave. He opines that from now on I ought to live in apartments rented out to me by reliable friends, not by some unknown third party. These friends could then help me to build up a new identity. This alone would guarantee that no one else would really know who I am and where I come from. Well, isn’t this a comforting perspective, I think to myself. So I will dig myself in even deeper into English soil...

I have my breakfast an hour later with Corrine. We sit in what is perhaps the dirtiest kitchen in the world. I still haven't lost my German attitude towards cleanliness and tidiness...

Half an hour later I am on my way back to Crowlink to pick up my family. When approaching the cattle grids that I have to pass to get to this remote settlement, I wonder what has become of that strange BMW. Just as I turn into the cul-de-sac leading to my place, I see it parked on a neighbor's parking lot. Uhhh, they are just visitors who didn't know the way! So they followed me yesterday not because they wanted to handcuff me, but because I lead the way into the lost world of Crowlink. A big sign on the fence at the cattle grid reminds people that no cars are allowed beyond this point, and who wants to drive into a cow pasture anyway? So most people cannot even imagine that there are houses hiding in the valley behind a dense wall of trees. This place is indeed great for all people who want to be totally cut off from the world. There is no mobile phone signal in this valley, and only very few radio and TV stations can be received in poor quality. When I got an ISDN line installed at my place, British Telecom did not even know where it is. They had a hard time finding their own equipment...

I get out of the car and meet my neighbor Andrew who is working on his car.

"Hello Michael, how are you doing" he asks me.

"Thank you, fine. And you."

"Fine, thanks."

So he hasn't read the *Telegraph* article, or at least he wasn't able to identify me with their help. My pseudonym is still safe.

I tell my wife about the BMW, and she sighs in relief. We take all the time we need to get the stuff into the car. Then we drive to the local train station and take the train to London. The kids are all excited. Riding a train is something special for them, even more so than flying. Times change! In London we make our way through the underground system and by bus to the zoo. The zoo, however, turns out to be rather disappointing, which may also be a result of the advanced season. Many animals are no longer outside. But also in other regards this zoo seems to be inappropriately tiny for a city of ten million people. My wife claims that the Wilhelma zoo in Stuttgart is much nicer. But the kids like it here anyway. Around 3 pm we have to leave toward the airport. We wait in vain for half an hour at the bus stop. In order to avoid arriving late at the airport, I decide to get a taxi to the next underground station. I take Kay onto my shoulders, a rucksack onto my back, and

two luggage bags into my hands and rush ahead. My wife and Tamara have problems following my pace. I swiftly find my way through the confusing London underground system from one line to another, stairs up, stairs down, left tunnel, right tube, onto the Northern Line southbound, change at Leicester Square, stairs up, left turn, stairs down, onto the Piccadilly Line, westbound. Everything has to go fast, and I drag my totally confused family behind me who have lost their orientation. While changing to the Piccadilly Line out west toward Heathrow, my wife says in desperation:

“How do you know we are right? Where are we in the first place? I would be completely lost here if I didn’t have you.”

“Well, I simply have understood how the system works. Just trust me. We don’t have time for long explanations.”

Only after we have sat down in the underground train to Heathrow, can we settle down, and I find time to explain her how the London underground system is organized and why I know my way around it. It is simply experience. On this 45 minute train ride out to Heathrow I explain to my wife that for security reasons I am not going to go with her to the check-in counter. I shall stay in the background, observing what is going on, while she checks in.

“I understand,” she replies.

“I don’t think there is any real danger,” I continue, “but there is a theoretical possibility that they know you are here and when you leave. They could know, if they have access to the airline data. I don’t have to remind you that in 1995 they handcuffed Günter Deckert right at the gateway when he returned to Germany from his two weeks’ vacation on the Canary Islands. So they definitely can do such things.”

Günter Deckert was prosecuted in Germany because in 1991 he had translated a “Holocaust-denying” speech held by the U.S. citizen Fred Leuchter, an execution technology expert who, in 1989, prepared an expert report about the alleged gas chambers of Auschwitz and Majdanek. Leuchter had concluded in his report, and summarized in his speech, that there were no such gas chambers. Deckert was eventually sentenced to two years for his translation. His leaving the country during his ongoing legal proceedings was interpreted by the German court as an attempt by Deckert to flee the country – stupidly enough. If he really intended so, he would not have returned.

I have a talent for scaring my own wife to death. I always tell her about the odds of what I am doing and the probability that something might go wrong, as well as about the implications. It is simply in my

genes. I hardly ever lie. I am bad at it. My wife quickly figured that out only a few months after we first met. She can recognize it at the tip of my nose when I try to hide something – Pinocchio. Everybody can do that after a short while. I am perhaps the worst liar in the world. In most cases, I do not even try to hide things, but instead demonstratively expose them. That has always gotten me into big, big trouble, even as an infant when dealing with my sometimes quite violent father, as my mother used to tell me.

At Heathrow Airport I indeed stay in the background while my wife checks in. I see the irritation in the faces of my kids who have lost sight of me and are now looking around for me. I try to prevent them from spotting me, as it might have bad consequences if they call my name and run over to me. It pains me to see the kids so confused.

And indeed, there is trouble ahead. The lady at the counter takes my wife's tickets and leaves for more than 5, 10 minutes. I get nervous. But it turns out that it was just a reservation problem. They get it sorted out, and as soon as my wife, who has lost sight of me, has checked in her luggage, she takes her carry-on luggage and the kids by her hands and walks over toward the security gates. When my wife is back in the crowd of people, I join her and help her carry her baggage. We spend some 30 minutes together in a restaurant before going to the departure door.

“Would you do me the favor and try not to cry when we say good bye?” my wife begs. “Otherwise we are all going to cry in the departure hall, and the kids will be in a terrible mood during the flight.”

“I'll try my best.” I really will. But then, when we give each other hugs, my eyes get wet. I manage to suppress more tears.

“Bye daddy.” I fail to suppress, but regain control. And I lose it right now while I am typing this.

“Hurry on, I lose control,” I urge my wife. She understands and passes the X-ray check without looking back. I turn around, not looking back either, going straight back to my car.

Preparing the Flight

On my way back to Uckfield I try to concentrate on the tasks ahead. As early as June 1999, during a journey across the United States, I researched possibilities to emigrate to the U.S. By that time I had learned that revisionism can have success only if presented in the world language English. I therefore decided that I would try to make this success

happen by working from within the U.S. Since my family has left me for good, there is nothing left that forces me to stay in England. Every corner, every road, even every store and supermarket there evokes painful memories of my family. Apart from that, the United States has this divine invention called freedom of speech, that is: the First Amendment. Is it therefore not logical to try to make my way to the country of infinite possibilities?

During my second visit to the U.S. end of September 1999 I managed to get an offer by a small publishing company called Theses & Dissertations Press, owned by Dr. Robert Countess, to work as their editor. I decided back then to emigrate to the U.S. It all depended only on immigration formalities, which could last for many months or even years, to be sure. But now, after the witch hunt against me has started in England, things look different. I can no longer wait until I receive a working visa or a green card. Tony and I decide instead that I would simply travel to the U.S. with a visitor visa waiver. Everything else would evolve later.

Back at Tony's place, Corrine informs me that Tony wants me to come to Uckfield to discuss things further. So I don't hesitate a second, turn around on my heels and drive up to Uckfield. I won't drive to Tony's printing company directly, though. Perhaps they are watching out for me. So I leave the car at the Tesco parking lot and walk down the main street instead of the side road leading to Tony's factory. I try to get into the factory lot from the back. I never went that way, did not even know that one can get access from the back side. But I am lucky: all doors and gates in fences are open. Safe is safe...

"Hi, Germar. How were things at Heathrow?" Tony greets me.

"Not too bad. We did it fast and painless, almost."

"Graham offered his help. You can stay with him in his house in Henfield for a couple of weeks if you like."

"Oh, is he in?," I ask Tony.

"Yes, doing his work. It's too noisy right now in there, but I'll tell him to finish that job and come here to discuss things with you."

"Thanks. Is Howard in, too?"

"No, he'll be around tomorrow."

Graham Jones is Tony's only professional printer, the jewel of his staff, and the only one not involved in any politics. So I wonder what makes him offer his help. We make it short. He gives me his address and phone number, and a description on how to get to his place. He says he'll be in at about six in the evening, so I shouldn't be there any earlier.

er, since he lives alone. I can stay in one of the empty rooms of his sons who are at university, he suggests. I tell him that I would need to bring my complete computer equipment to his place in order to keep my business going for the next couple of days.

“Is that alright with you?” I ask him

“How much stuff is it?,” he asks in return.

“You never saw a PC, huh?” I tease him. “It all fits on a medium size desk. So it’s not a big deal. I just need to have a telephone socket close to it or an extension leading to the next socket.”

He agrees to this, though I see a worry in his face that I might screw up his household.

“Don’t worry,” I try to comfort him. “I work silently in an orderly manner all day, and you will not even notice that I am there. And thank you very much for your help!”

I promise to be at his place early that night. I leave shortly afterwards, drive down to my rental apartment in order to pack all the stuff together that I would need for the next couple of days: clothes, food, paperwork needed to continue my work, and of course the computer equipment. It takes longer than I thought. At dusk I leave for Graham’s residence. After getting lost once in the dark, I make it to his place at around 7 pm. He already expects me and helps me to unload my car and carry the stuff into his son’s bedroom.

After having sorted my stuff, I join Graham in his living room. He is very polite and even switches off his TV when I enter. That is not normally the case when you visit English households!

“May I ask you why you offered your help? I mean, you don’t know me, do you?”

“Well, I have seen you frequently at Tony’s factory, and you don’t seem to be a bad guy deserving that sort of trouble,” Graham explains.

“Are you somehow politically involved in anything?,” I am curious to find out.

“No, I have no political agenda whatsoever.”

“How then did you get involved in Tony’s printing business?”

Graham then tells me his story of how he was searching for a new job after he left a position where he had been absolutely unhappy as a professional printer. So he applied for several jobs, and one of them happened to be Tony’s company.

“But that is a third world printer with totally outdated machinery, swamped in dirt and rubbish, and entangled in total organizational chaos. How can you volunteer to work there?”

As harsh as this judgment sounds, it stems from Tony himself. He himself stated once, he needs an arson or a flood every once in a while in order to have a good reason to muck out his factory.

“That’s true,” replies Graham, “but I am the only professional there, I can realize my own ideas, I am almost in a position of being my own boss. And I can get my favorite fish prints printed and marketed. Fish and fishing is my real hobby, you know, so it came in quite handy.”

Now I feel that it is up to me to tell him my story.

“Do you know at all why I am in this mess?” I ask Graham.

“Not really. I heard bits and pieces. Tony explained to me once that Wolfgang has added something to your report without informing you.”

“That’s right. Now that you offered your help, are you curious to hear more about it? You should at least know the reason why even you might get in trouble now,” I tell him with a smile on my face.

He is curious, and so I spend the next couple hours telling him my story.

“But why didn’t you tell the court the entire truth about who actually did all of this, if not you?” Graham asks me toward the end.

“You mean I should have betrayed the real ‘culprit’? It was certainly stupid what he did. But if you look at it objectively, it is nothing that anyone would deserve to be put in prison for.”

“But you were sentenced for it.”

“Yes, but I was so naïve to think that a German court wouldn’t sentence someone for something he obviously didn’t do. I assume that the court which sentenced me had a strong inkling as to who the real ‘culprit’ was. But they had no conclusive evidence against Wolfgang. What they found during the first house raid against me in September 1993 was a lot of circumstantial evidence pointing at the real ‘culprit’, who at that time was the central figure in German revisionist publishing activities acting from behind the scenes. It was also obvious that Wolfgang was a good friend of mine.

They launched a huge house search campaign against Wolfgang in August 1994. They searched eight places all over Germany where they thought he was hiding stuff. But for some strange reason, we were warned by someone inside the *Bundeskriminalamt*, which is Germany’s equivalent of the FBI. So you see, we can count on having supporters hiding somewhere inside the system. Consequently, this gigantic house search action was a total failure.

I figured that the trial against me was their last attempt to get at Wolfgang by forcing me to betray him, or by forcing him to confess in

order to avoid that I, as an innocent father of two infants, would be sent to prison. That failed, too.

Make no mistake: Wolfgang would have gotten the maximum sentence, for sure, that is: five years in prison, because distributing my expert report was only one point on the long list of thought crimes he would have been indicted for. If anyone was obliged to tell the truth about what had happened with my Expert Report, then it was Wolfgang himself. But by so doing he would have incriminated himself massively, so you really cannot expect him to make such a sacrifice. Be that as it may. At the end of it all, none of us went to jail, and everybody else involved in these matters got away as well. We all keep publishing for revisionism. So what's the point?

Even though I certainly do not agree with everything my friend wrote and published – and I really was mad at him for his additions to my report – I would never betray anyone in free speech matters that would lead to his imprisonment. It is that simple. I don't want anyone to denounce me for what I said or wrote, so I am not entitled to denounce others either.”

Graham is much more comfortable with my being in his house after I told him my story. People get excited and intrigued by such stories that almost sound like a spy or conspiracy novel. Being a small, not too endangered part in these adventures is something they really appreciate, provided they don't get into hot water...

During the next two weeks I organize all the things that need to be done: Doing my correspondence, filling orders, getting the book “Giant with Feet of Clay” and the issue 4/1999 of my German magazine to the printer, and last but not least shutting down my second identity at the settlement I call my home. Howard is a big help there. He rents a van, and we drive all my property up to Uckfield and store it temporarily in a shipping container on the lot of Tony's factory, waiting to be shipped to wherever I might go. Howard agrees to be my officially employed packing and mailing clerk and to get co-signatory status for my British bank accounts in order to do all the business that needs to be done. This way I can keep up the illusion to everyone – authorities as well as customers – that I am still in Britain. The only problem will be that correspondence has to be forwarded in a time-consuming way.

While filing the co-signatory form, the clerk at my bank's branch is friendly as usual:

“Hi, Mr. Scheerer! How can we help you today?”

It makes me feel at home when people know me by name and don't call me a Nazi. I will miss that. My small storage room I rented for my books and journals needs to be cleaned out, too. I hope the guy there hasn't heard about the *Sunday Telegraph* affair either.

"How are you doing today, Germar?" I am greeted. That is like pouring balm on my wounds. At least I don't appear as a monster to him – or he simply didn't hear about the *Telegraph* smear campaign. So I introduce Howard to the owner of the storage company as the guy who will deal with him from now on.

In the meanwhile, my siblings cancel their visit for the following weekend, which they had planned on the occasion of my 35th birthday. They had been informed by my wife about the mess I am in. I am sorry about that. I would have needed some distraction, but they are probably absolutely right about it. So my siblings won't need the bed & breakfast place I had reserved for them with my dear old friend John Ryder-Smith in Jevington. John is a nice fellow of more than 70 years of age who had become a close friend of ours, especially of my wife. I do not want to upset him with my own problems, so I wonder how I explain that to him. It was already hard on him to see that my wife left me and went back to Germany with my kids.

Graham tells me the next day that his mother will visit him at the very same weekend my siblings had originally planned to come: Hence I could not stay at Graham's place during these days, because he would not want his mother to ask any questions. So I drive over to John's place and tell him that my siblings will spend the upcoming weekend nights at my place, since they prefer a double bed (what John might think about that one?), and that I will use his room for that weekend instead. This way I get out of Graham's house for the weekend, and John won't get worried about my collapsing world and won't ask any funny questions...

That reminds me that I have another appointment for that weekend which I totally forgot. Marc Dufour, a French revisionist writer, wants to visit me to discuss his upcoming book *Die Lüge spricht zwanzig Sprachen* (The Lie Speaks Twenty Languages), which he had offered me for publication. He already bought the Channel Tunnel ticket. He is going to be pissed. I call him from a public phone and tell him that I cannot see him. He is upset, indeed. I cannot explain to him exactly why I cannot see him, so I have no way of placating his ire. Anyway, it had to be done.

Tony and Howard promise to get the shipping of my property going as soon as I inform them where to send it. I give Tony a check over £3,000 which I ask him to deposit *after* I left the country. In return, we agree that he will give me £3,000 in cash the evening before I leave, about which I will inform him two days in advance. This way I get enough money for the journey without triggering any alarm bells in the bank. You never know...

Next I have to figure out which way to leave this country. England, I really love you, I don't want to leave you. But you apparently don't love me. You hate me. I have understood, though I know that you wouldn't do so if only you would listen. It makes me already homesick to just think about leaving.

Leaving the country by plane is too dangerous. When I left Britain in June 1999 for a two week lecture tour to the States, the officer at Heathrow Airport checking the passports took mine and hesitated.

"You are a German citizen, right?" he asked me.

"Yes. Why?"

"Why do you start your journey here in London?"

"Because I live here in England."

"Where do you live?" he persisted.

"In Eastbourne."

"Do you have any British identity?"

"Mpff – I only have my Social Security Card."

"Alright, give me that."

I handed it to him, and off he went, vanishing for some two minutes behind a door. My heart beat faster and faster, I started sweating. That was the first time since I had fled Germany that I was subject to passport control. What would happen? And idiot me told him that I live in Eastbourne. Don't you know that your Social Security Card is registered with Howard's address in Hastings? Oh, boy! There was trouble ahead!

The guy returned, gave me back my passport and social security card, and said everything was alright.

Pooooohhhhh.

Remembering these frightening minutes, I figure that a single entry in some sort of database that those security guys use to check identities might be enough to cause a different outcome the next time. It also would not be wise to leave an obvious trail by having my name on the passenger list of a flight from London to the U.S. So I better not leave from a British airport. Crossing the channel isn't an option either, be-

cause passport controls are pretty strict there, too. The only option is Ireland, indeed. Independent southern Ireland. Crossing the Irish Sea on a ferry shouldn't be a big deal, and since southern Ireland has no security problem as Northern Ireland has, I think that passport controls for passengers of a ferry should be quite lax.

Graham tells me that there are tickets available at railway stations that include the ferry fare. So while doing some business in Eastbourne I go to the local train station in order to get information about this. Most important, however, is the question: Do I have to give them my real identity when buying a ticket? I don't want to appear in any database as having left Britain towards Ireland. So that would be crucial. Since I don't want to risk anything, I leave all identification papers at Graham's place. It turns out that I indeed have to give my name and address, but I don't have to prove my identity with any kind of ID. What a relief. So I purchase a one-way ticket to Dublin in the name of my false second identity: Michael Martin. Everything is fine.

Next I clear and clean my rental apartment, so that Howard has only little work to do once my rental agreement runs out in January 2001. After this work is done, I leave my settlement for good. The sun is about to set and pours its golden beams over the pastures. Even the sheep look golden. I really do not want to leave. Isn't this just a bad nightmare? Can't someone wake me up?

I get out of the car, and sit down on a bench right at the fence near the cattle grid to watch the sun set a last time over my home. I will be terribly homesick. Look at this! Burn this colorful view into your memory. This is the last time you will ever see this.⁵⁸⁶ It will be rare soul food for many years to come in foreign countries...

It is Thursday evening. My train leaves on Saturday, the 13th of November. I decide to have a last dinner in the Tiger Inn of East Dean, my favorite place to go. While standing at the bar ordering my food, I notice a young couple and a middle aged woman talking with heavy German accent, the two women talking entirely in German together. I decided to join them, just for the sake of not sitting around alone. I speak to them in English. The young guy is obviously English, but the young lady is German, and the older lady, her mother, too. Both Germans don't notice that I am German. The English guy notices my accent, but can't get it sorted, though he is engaged to a German. I let them guess

⁵⁸⁶ Well, it turns out that I did return – 9 years later, to live in Eastbourne right next to these wonderful Downs for an entire year. But I never went to that particular spot in the Downs. I feared the emotions this would evoke.

what my native language is, and when I reveal it, the girls are stunned that I was able to follow their secret conversation all the time. I like these games. I was pretty bad at English in school. I finished with an E. And now, not even all English people would recognize my accent anymore. Anyway, this evening was successfully filled with something other than sorrow and pain.

The next day I finish the last bits and pieces and try to get things ready to go. In the evening, when getting all things ready, I notice that my passport isn't where I thought I put it last. I am totally upset and scared: Where is my passport?

I reopen and search every box that I packed (at least that is what I think I do). I turn every piece of paper upside down. Nothing. It is gone.

When Graham returns from work, I tell him the bad news. He calls Tony to cancel the meeting we had agreed upon to hand over the £3,000. Together we try to remember all the steps I took.

The next morning I go to Tony's place, telling him about my lost passport. We all search his house. Maybe I lost it there. Nothing.

I drive to my empty rental apartment to see if it is there. Nothing.

Did I lose it on the pastures the night I walked through the storm? No, that cannot be, as I definitely had it at Graham's place.

Did I lose it in the inn when carelessly throwing my windbreaker on the bench with the heap of all the other jackets? Or did I lose it at the Beachy Head restaurant the other day? All inquiries at these places lead to nothing. Where is that damn thing!

Tom Acton, the fourth guy of Tony's printing company, cheers me up that weekend by inviting me for a long walk around Devil's Dyke north of Brighton, and for a badminton game. He beats me. I have been out of practice for over ten years now, so no wonder I couldn't cope with him. He tells me that he is practicing secretly because Tony has been inviting him for several months to join his badminton group, and he wants to surprise him with a gigantic performance when he eventually joins this group as a greenhorn. You will do it, Tom! I had no problems beating Tony and his friends even with the bad shape I am in now, so you will certainly beat them all!

Not giving up on searching for my passport, I decide to simultaneously try to get a new, replacement passport from the German embassy in London. I gather all the information I need. It turns out that I can get a provisional passport in a few days. However, a proper passport requires some six weeks to be done, but it can be sent registered mail to a street address. So on Monday I have some passport photos made. I

haven't shaved myself for almost two weeks now, so the portraits look pretty terrible. I still have a German plug on my shaver, and Graham doesn't have an adapter for it, so I cannot do anything about it. Anyway, it'll do. The photos just resemble me the way I look now!

I get on a train to London Victoria and then make my way by the London tube to the German embassy. I enter the building with a sick feeling in my stomach. I quickly get the forms I need and fill them out. Then I hand them over to one of the clerks at the counter. She enters my details into her computer.

Let's see what happens.

She hesitates, looks closely at her screen. She puts my application down and comes back to the counter:

"Would you please sit down for awhile, Mr. Scheerer?"

"Why? What is wrong?"

"There is a problem. I have to check this first with my boss. Please sit down over there and wait awhile, would you?"

I smell a trap. I pretend to sit down. She looks at me, sees me sitting down, then goes out the door. I jump up from my seat, and out the door I go. You better not go back to German territory anymore, not even to an embassy! They have you in their system!

I cross the street and head for the next underground entrance. A big black limousine stops in front of me, blocking my way. I almost start to run. It turns out that the guy is just looking for an address. I cannot help him, though. I probably wouldn't, even if I could. I quickly get into the underground and vanish. Get me out of here!

As soon as I am back in Brighton, I look for the first public telephone and call the embassy. I manage to get through and get hold of the lady that dealt with me. I apologize to her that I couldn't wait and ask if she had found out what was wrong.

"There is a passport refusal ground in your record" she explains.

"What does that mean?" I ask.

"That means that there is some reason why the German authorities would not issue a new passport for you."

"What sort of reason is it, can you tell me that?"

"No, I am afraid not. Our records don't say anything about that."

She is probably right. It isn't her fault. She might really be ignorant. Well, I am not, but I certainly wouldn't tell her. So I hang up and get back to Graham's house. What else can be done? Perhaps I do not even have to leave Britain? Perhaps they cannot extradite me at all for legal reasons? How about getting some legal advice for a change? Already in

1997 I had been in touch with a lawyer who was experienced in similar cases. He is familiar with my case and might even have learned from the media what is going on. So I call him from a public phone. It turns out that he is already aware of my situation, as he had seen the *Telegraph* articles.

“So what do you think is most likely going to happen if they find me?” I ask him.

“European extradition law has massively changed during the last years. As I understand it, you were sentenced for a crime in Germany that formally is a crime in Britain, too, with similar punishment. Under such circumstances, citizens of the EU are subject to immediate extradition without any further legal ado.”

“But the crime I allegedly committed would never lead to any prosecution in Britain, not to mention to a verdict,” I retort.

“That is certainly true, but you won’t get a single British judge to listen to you. Your case is to be handled on a mere executive level. The justice system does not even get involved. At least I consider it 99.9% likely that nobody will listen to what you have to say. You have no right to be heard legally.”

“So there is no hope whatsoever?”

“No, I am afraid not.”

“Thank you for your advice.”

Was that the end of the story?

In the meantime, everybody is searching feverishly for my passport, but nothing turns up anywhere. Graham even makes an inquiry at local police stations, asking in general for lost German IDs handed in, but not a single one has been found. It would have scared me if they had one. It could be the perfect trap. I ask Howard that he may eventually try to get my unused ticket to Dublin reimbursed, which he promises to do. Due to the delay of my departure, I at least manage to correct some more errors in the forthcoming book. The proofs I get on Wednesday for “Giant with Feet of Clay” have a totally screwed up Table of Contents. Good that I could fix that...

Now a new plan is given out: I shall leave for Ireland, hiding there under a new fake identity, hoping that they won’t search for me there for years to come. Even if I cannot reach the U.S. for lack of a passport, Ireland certainly is a safer place to be than England, not only because they are not looking for me there, but also because Ireland refuses to extradite individuals accused of having committed “thought crimes” – Sinn Fein and the IRA being the reason for that. I already got in touch

with a friend there who is willing to give me shelter for a few weeks until I find a place to stay, and who wants to help me build up a new identity by guaranteeing for tenancy agreement and bank account.

On Thursday night I finish my last correspondence and figure that on Friday I might get things sorted for a departure to Ireland on a different ferry, this time with my car. So I open a box in which I am collecting recent correspondence that I dealt with at Graham's place, in order to add the new correspondence to it.

I don't believe my eyes: My passport is patiently sitting in there, grinning at me!

When Graham comes home, I tell him the good news, but urge him not to tell anyone. If there is a leak in the system, this disinformation would serve wonderfully on my behalf.

"This is ingenious! Did you plan this right from the start? Was it all a big show?" he asks totally overwhelmed.

"No, it was unfortunately real. I really was at the end of my wits. I stupidly packed the passport and stamps and all other stuff into that last box that I kept open for the last documents that I wanted to collect. It never occurred to me that I could have been so stupid and include the passport in there. After all, I would need to have it with me all the time, not hidden in a box in Tony's container waiting to be shipped. At any rate, it comes in quite handy that everybody thinks I lost my passport. I even told David Irving about it. I am sure this bad news already has gone around the globe. And even the German authorities believe that I sit in a trap. Let them think this is true."

"That is perfect!" Graham said.

In the Land of Infinite Impossibilities

The next day, Friday the 19th Nov, 1999, Graham informs Tony that I would leave on Saturday. This is the signal for him to get the £3,000 and to meet me that night. I go to the Eastbourne train station to get a new ticket for Dublin, and this time nothing will stop me! (Hopefully)

I meet Tony at 8 pm at an Italian restaurant in Hove. He gives me the money and invites me to my last dinner in England. We spend some nice hours together talking about all sorts of things.

Where would I be without these friends?

My train leaves Saturday early in the morning from Eastbourne. I get out of Graham's house well before he gets up. I take a different route through Alfriston, Litlington and East Dean in order to see at least a

part of my beloved home for a final good bye. I park my car near the train station. Howard will eventually use a second key to try to sell it to the local Renault dealer.

The journey to the ferry harbor of Pembroke via London on the train is absolutely relaxing compared to the last three weeks. I hum a Carpenter song which I love while the train is leaving Eastbourne:

"I beg your pardon. I never promised you a rose garden. Along with the sunshine, there's gonna be a little rain sometimes."

Well, such is life!

In the ferry port I have to hand over my luggage – just one bag – to a guy, and enter a coach. Being separated from almost everything I now possess makes me nervous. Don't screw it up, guys! I need my clothes! That's all I have! The bus drives right into the belly of the ferry – the right one, I hope. We don't need to get hold of our baggage. They do it all for us. Why is it that I don't trust them?

Of course nobody controls our IDs when leaving Britain's coast, but it makes me relax to actually see that it really doesn't happen. The journey is quiet, boring. What would you expect? I try to flirt a bit with one of the girls at the delicatessen counter. That is about all the excitement you can find here, I guess. The movies they show don't interest me. I cannot sleep either, so I just sit around and stare into the Irish Sea and let my thoughts wander around: First the coastal line of England disappears in the distance, a coast that had become home, and then, after some two hours, the Irish coast approaches.

Regarding ID control, it is of course different when arriving in Ireland, but it is nothing more than a guy taking a glance at my passport. No scanners or computers anywhere in sight. That is the difference between airports and ferry ports! I like it!

"Where do you come from?" the guy asks me. What sort of question is that?

"From England, of course. I mean, the entire ferry came from England, didn't it?"

Perhaps he wanted to know where I live, but the answer to that wouldn't have been any different. Anyway, he doesn't care and lets me pass. It takes a few minutes before I receive my bag, and a few more to find a bus driving to downtown Dublin. It turns out that the ferry port is at the far south of the city, whereas the airport is in the north. I get on a bus to downtown Dublin, and from there on a bus to the airport. It is already after 6 pm when I arrive there, and none of the airline counters offering direct flights to the States are open. I have to come again to-

morrow, some lady tells me. They would open at 8 am. What a disappointment. I wanted to get out of here as quickly as I can. But since nobody knows that I am here, it doesn't really matter.

I ask a taxi driver where I can best spend the night. He is a nice guy and tells me that prices are lowest in a certain area close to downtown and that he'll drop me off there. So I enter his van, and while driving to what turns out to be a youth hostel, we have a nice chat about the English, the Irish, and the Germans and their relations to one another.

At the youth hostel I have to deposit my ID card, which I don't like to see, and my details are being entered into a computer, which I hate to see. But I am quite sure that no hotline leads from this cheap youth hostel to London or Berlin. It is just that I hate to leave traces.

After eating some of my food supply, I decide to have a walk through downtown Dublin. We are approaching Christmas, and so the town has its usual Christmas decorations everywhere. However, I am a bit disappointed about this city. But I don't have to stay here, so why bother...

I spend the night together with some ten guys in a large dormitory, and I get up at around 5:30 in the morning, take a shower, have my breakfast, get my ID back from the clerk, and head for the airport in a taxi. I am too early and have to wait until the ticket counters open. It turns out to be not all that easy to get a ticket for today, Sunday, the 21st, but I manage to get one for roughly 1,000 Irish Pounds. Destination: Huntsville, Alabama. Right into Robert Countess' place. He wants to have me as an employee for his publishing business, so he will have to cope with my sudden arrival, even though I haven't said a word to anyone that I am coming.

As a matter of fact, my flight first goes from Dublin to Shannon, where we all have to leave the plane in order to pass through U.S. immigration and come back aboard afterwards. That is strange. I didn't know that they even do this abroad. So be it. Perhaps it is a huge advantage, because if anything goes wrong with the U.S. Immigration Services, then they don't have to deport me. They just dump me in Ireland, and that would be my second choice anyway. Getting caught in New York or Atlanta would be much worse. Any deportation to Europe, with the authorities there being informed about it, would certainly end with my incarceration. So, thank you Jesus!

I have to fill in the usual I-94W visa waiver form. I know that this is not the way to enter the States when getting employment. I had some fights with Bob Countess about it. Already in October he got in touch

with an immigration lawyer, and she claimed that I can come with a visa waiver and that it can be adjusted. I didn't believe it, because I remember from my first two times I filled in this I-94W form that it stated that one cannot be employed in the U.S. when entering the States with such a waiver, and that any adjustment is expressly excluded. But Dr. Countess insisted that he asked that lady twice, and she allegedly confirmed twice that it can be done. Anyway, I don't have much of a choice right now, and if it turns out that it cannot be adjusted, we have to find other solutions.

The immigration officer looks at me in my sweat pants and at my ticket.

"You have only a one way ticket. We cannot permit your entry with just a one way ticket. You need a return flight."

Sh... What do I reply to that?

"Yes, but I do not yet know when I am going to return. That is why I didn't book a return flight." I tell him.

"What is the purpose of your journey?" he asks.

"I am about to expand into the U.S. market and want to open a kind of business branch of my publishing company there. It'll take some time, and I will have to travel a lot."

He looks at me in my casual clothes and my unshaven face, and doesn't seem to really believe me. I certainly don't look like a business man who is expanding his company on a world-wide scale. However, that is what I really want to do and what my business with Bob Countess is all about. And finally, I really want to return to England's sunshine coast, once they let me...

The border official murmurs, makes his stamps in my passport, and says something like:

"You'd better get a return ticket next time you fly to the U.S."

Well, I like return tickets that work, but any return ticket to Europe is not going to work for me, I am afraid...

And off we go! Hallelujah! I made it!

The flight to New York is as boring as all flights are, and I need to wait several hours for my connecting flight to Huntsville. I arrive there at 9 pm local time. Bob Countess is already in bed at that time, so it doesn't make sense to call him. I call Craig Cox instead, a friend of Bob with whom I stayed already in June and September 1999 during my two lecture trips. He and his wife Suzan are certainly up at that time. But... they don't answer the phone. I try it again, and after a while I get through.

“Hello?”

“Hi Craig, it’s me, Germar”

“Oh, how are you doing?”

“Fine, thanks. Listen, I am here at Huntsville airport.”

“Oh, really? So you made it, huh? I didn’t know that you were coming!”

“Well, that was the purpose of the whole exercise, wasn’t it? Anyway, yes, I made it. May I ask you if I can stay the night at your place, and if you could pick me up here, please?”

“Sure. My home shall be your home. I’ll be at the airport in half an hour. Does Bob know you are here?”

“No. Nobody knows. You are the first I’ve told. You know, I didn’t want to bother Bob, as he is certainly already sleeping.”

“That’s fine with me. You are really welcome here. You can even stay longer, if you wish.”

“Thanks. And don’t tell anyone yet!”

“Sure. See you.”

“Bye.”

Craig comes some 30 minutes later, and we drive to his place. Suzan welcomes me in her friendly way that really makes you feel welcome. I have seen these guys only twice for not too long, but that sufficed to make it a real friendship. I know I can count on them.

Craig calls Bob the next morning and tells him about a big surprise that is waiting at his place for Bob to be picked up. He doesn’t tell Bob what it is, though Bob urges him to explain.

A few hours later, Bob drops in with his VW New Beetle and is really surprised to see me waiting for him. We have a nice drive back to his place, during which I tell him about how I again absconded the European Thought Police. I ask him if he would allow me to get in touch with Linda Faith, a lady I met in Cincinnati at Irving’s Real History Conference in September this year. “Certainly,” he agrees. I shouldn’t even ask.

I have been in email contact with Linda for several months while still in Britain, and I hope to find more than just a friend in her. Since I don’t know where to stay, I decide to call her and ask her if I can visit her. She is surprised to hear my voice and is happy to meet me, but urges me to wait until the coming weekend when her kids are at her father’s place, so that she has time for me. So it is arranged. I get a plane ticket for the next Saturday, returning Sunday.

Bob informs me that he has dumped this lady lawyer, which appeared to be not very competent, and has found another immigration lawyer in Birmingham, Alabama, a guy from Bangladesh who made a good impression on him. We shall visit him next week.

On Saturday I fly to Cincinnati, where Linda picks me up at the airport. She invites me for lunch at LaRosa's Pizzeria. I take the opportunity to ask her if she would be interested in being employed by Theses & Dissertations Press, Bob's publishing firm that I am supposed to become the director of, once my working visa is granted. She is really enthusiastic about it and more than happy to say yes. After lunch, Linda decides to show me her house, which she is currently trying to sell. So we get back into her car and drive a few miles. While approaching the house, she slows down and gets nervous.

"Oh my gosh, police everywhere"

"Some four or five cars," I quickly count.

"You must know that I have trouble with my son Paul. He is on medication for schizophrenia and has absconded from the hospital where he was supposed to stay by police order," Linda explains.

"So the police are here because of him?" I ask.

"Almost for certain. Look, that is my house. They are all around that house!"

Linda drives by very slowly. Suddenly one of the police officers gets suspicious about the slowly passing car and goes after us. In a second we are surrounded by some ten cops, some of them pointing their guns at us.

"Oh my gosh, they are aiming at you!" Linda says.

"Get your hands up," one of the police officers shouts, but somehow I do not believe that they mean me. They cannot. Why should they? So I open the door in order to ask them what this was all about, which really is a big mistake. These cops are extremely nervous and excited. They interpret my move as a threat. One officer points a gun right in my face, another drags me out of the car and pushes me face down into the grass. A third one handcuffs me. That's it...

Everybody is totally excited, especially Linda who desperately tries to convince the police officers that this is not the guy they are looking for.

"This is not my son. You got the wrong guy. Please let him go!" Linda is extremely upset.

“Who are you?” they ask her. They pull me up from the lawn, and Linda identifies herself, explaining that the one they are most likely looking for, Paul, is her son.

“But this is not my son. This is a visitor, a friend of mine who just arrived in the U.S.!”

“Ma’am, don’t get excited, stay back and wait until we have checked his identity. If you are right with what you are saying, then there is no reason to be upset.”

I am shivering. The entire neighborhood is now gaping. I tell the cops that my passport is in the jacket on the backseat of Linda’s car. They get it, and one officer gets in his car to check my passport. Another officer talks via a phone to someone, getting information about the guy they are looking for. They are informed that Paul has tattoos on his arms. So they quickly lift my sleeves, just to see that there is nothing.

“That’s not the guy. We got the wrong guy. That’s not him.”

The officer checking my passport gets out and just says “Nothing. He is clean.”

The officers take off my handcuffs and apologize for this.

“Well, having the usual prejudices about this country, this is pretty much what one expects to experience, isn’t it? It was a nice adventure, at least,” I tell them with a broad smile on my face.

Back in the car, Linda apologizes:

“Oh my gosh. You made it out of beleaguered Europe into the States to avoid being arrested, and I almost screwed it all up. I am so sorry for that.”

Welcome to America!

At least now I know that there is nothing on U.S. records. You always have to see the positive sides of things.

The Chase has Begun

My move abroad, using several diversions and distractions like an animal that has to deceive its predator, took some time. A few days only after I left England, two gentlemen appear at my official Hastings address, where I have claimed to live since 1997. They tell my friend Howard that they are looking for me. Howard, however, can tell them only that he does not know where I am (which is fortunately true) and that he only takes care of my incoming mail. It is strange that these two gentlemen are quite satisfied with this explanation. But perhaps they already know that they cannot expect any more details from Howard.

After all, I have not committed any crime according to British law, so they cannot do anything against my operating my legal business from underground with the help of friends.

Things are quite complicated initially, however. Our new mail forwarding system is rather sophisticated for security reasons, and it takes many weeks before the mail finally reaches me. It thus happens that some requests of my customers are not being taken care of in due time, which upsets some of them. If only I could tell them about the circumstances under which I am forced to work!

During all this upheaval, David tries to contact me. He wants me to assess an expert report that his opponents filed for his upcoming libel suit against Deborah Lipstadt. For security reasons I had to cancel all my British internet accounts, and it took a while for me to find a way to get access to the Internet again without risking that the British or German authorities could track down the location of my telephone socket. It so happens that Irving receives my comments only shortly before he cross-examines the most important expert witness, Prof. van Pelt. Irving's libel suit probably suffers tremendously due to that. Some friends suggest that this was perhaps the reason why they started that witch hunt against me at exactly this time. They want to cripple David Irving's means to conduct his case properly. Perhaps there is some truth to it. In an article in the *Los Angeles Times* of Jan. 7, 2000, Kim Murphy states in a rather fair article about revisionism that I could very well appear as an expert witness on behalf of David Irving. Maybe the thought of that made certain groups panic. But who of them knows that Irving never even intended to present me as an expert witness...

On Jan. 16, 2000, right at the start of the Irving trial, Chris Hastings from the *Sunday Telegraph* brags about his alleged triumph of having successfully slain the evil dragon – even if it is only an innocent, powerless young man:

"Neo-Nazi accused of 'racial hatred' goes on the run

[...] Germany has issued an international arrest warrant for Gernar Rudolf, who fled to England to escape a prison sentence for inciting racial hatred."

Not quite yet, Mr. Hastings, because the arrest warrant issued, which makes him so happy, is not the same as the actual execution of it! But the language is rather clear: a manhunt for a dissident in the "free" western world.

The manhunt turned completely into hysteria with a BBC report about me on March 28, 2000, which was repeated the day after by the

south English regional TV station ITV at 23:20. Six or seven photographs of mine were shown during the report which had been taken from my website www.vho.org. The public was warned to beware of this “Nazi sympathizer.” Mr. Michael Whine of the British Jewish Board of Deputies was pleased to appear before the cameras and announce that regarding me, England was dealing with a “new breed of dangerous Nazis.”

To understand the full extent of this witch hunt, one must realize what the British audience most likely considers to be a “new breed of dangerous Nazis”: In 1999 two severe bomb explosions in London killed many people. Most of the victims were members of colored ethnic minorities and homosexuals. The media claimed – prematurely, as usual – that “dangerous Neo-Nazis” were responsible for these bombs. Not even a year later, the BBC called me a “new breed of dangerous Nazis” hiding in the area of Hastings. What would the average Englishman have thought when watching this? A mass-murdering criminal running around with lethal weapons?

The local press chimed in once more with “Escaped Neo-Nazi still hiding in Hastings [...] he [...] was still being hunted.” (*The Hastings and St. Leonards Observer*, March 31, 2000). Obviously, the powers that be are striving to familiarize the local populace with my likeness and condition them to be afraid of me. It wants them to complain to the police about the desperado in their midst.

But did anyone really care? Well, on May 22, 1999, the British House of Commons felt obliged to briefly mention my case. The busy Labour member Andrew Dismore had asked the Secretary of State for the British Home Department during a session on prevention of crimes [sic!] to make a statement about my case. Although the home secretary’s response was not long, it was very clear nevertheless:⁵⁸⁷

“The Government are aware of the reports in some quarters that Mr. Rudolf may be in the United Kingdom. The police have also been informed of the allegations against Mr. Rudolf.”

This indicates clearly that my case has found attention in the highest circles, which assume that the police will solve that issue – with handcuffs, with what else...

Each year the Stephen Roth Institute of the University of Tel Aviv compiles a report on alleged anti-Semitism around the world. Following typical Jewish persecutorial paranoia, historical revisionism is listed in

⁵⁸⁷ www.parliament.the-stationery-office.co.uk/pa/cm199900/cmhansrd/cm000522/text/00522w13.htm#00522w13.html_sbhd1.

that report as well. Since the year 1999/2000, the section about German revisionism of this report is about one individual only: GERMAR RUDOLF. For decades now, the reports of the German Agency for the Protection of the Constitution list historical revisionism as an act directed at undermining the German state, an outrageous claim indeed. The report of 2003 states that I am the only revisionist left over in the entire world that does any work worth mentioning: "Only [...] GERMAR RUDOLF continued his activities as before."

Change of Scene

End of July 2000. All attempts to get a working visa in the U.S. have failed. I have left the U.S. to avoid trouble with the immigration services and have temporarily settled in Rosarito, Baja California, Mexico. I have rented a little house next to the home of Bradley Smith, head of the Committee for Open Debate on the Holocaust. From here I am planning my next move: to apply for political asylum in the U.S. It will be a desperate last attempt to get in.

During my 10 weeks' stay in Mexico, Bradley and I become close friends. In August I book a flight to Iceland via New York. Although Iceland is only associated to the European Union, it makes me nervous to have to show my passport when leaving the airport, but nothing happens.

The wind blows cold in Iceland's capital, chasing the clouds across the sky, and the sun struggles to keep temperatures within an acceptable range, even though it is August, just a few days after my mother's 59th birthday. She has come to see me, together with my ex-wife and my two small children. We meet in the middle between Europe and Mexico, where the continents divide and the earth's innermost is turned outside. By that time I have gone through an ordeal of persecution and prosecution because the powers that be could not let me get away with my knowledge and skills. And as it lies in my nature, I have not caved in, but resistance and pressure have made me even more resilient. The young student of days past has turned into a scientist of the most upsetting sort: I do my research where many powerful people do not want me to, and I publish the results of other peoples' and my own research that many authorities want to see censored. I have decided long time ago to abandon my splendid career chances of becoming a professor for crystallography, and to pursue what I see as the greatest of all adventures instead: to boldly go intellectually where no-one has gone before, just

because no-one wants to allow me to go there. Ostracized, slandered, prosecuted, sentenced, deprived of my academic title, kicked out of home, job, clubs, avoided by “friends” and even parts of my family, and finally also abandoned by my own wife, I now live abroad, on a different continent, all bridges burnt behind me. Looking back at the path of destruction my activities caused in my life, but also the havoc I have wreaked and still wreak as a one-man-show on a national as well as international level, my mother finally agrees:

“Yes, you are right, it is of tremendous relevance, but still, I cannot accept as a mother that one of my children puts itself in harm’s way.”

I am stunned by this late confession that my mother has been dishonest or misjudging:

“Now, after eight years, I have the first honest statement out of your mouth that I can accept. Was it so hard? I understand that it is the duty of a mother to keep her children out of danger, but mom, I am well over thirty now. I am responsible for myself, don’t you think? You know very well how I react when someone wants to force me to act against my will. You know me better. Whether it is my father who wanted to break my will or the German authorities that threaten me with incarceration for doubting the indubitable, it is the same thing. So why did you oppose me with these stupid dogmatic paradoxical statements? It drove me even deeper into it!”

They walk along Reykjavik’s beach promenade, and she goes on:

“I accuse myself for having raised you with this extreme moral outlook. Do you always have to be so honest and do you always have to tell the entire truth? Can’t you lie once in a while, or at least tell only part of the truth, if you know that your environment doesn’t want to hear the truth? As a boy you were always looking for a reason to understand why your father treated you so harshly and often unjustly. I told you about how he and his family were treated unjustly after the war, and I think that this is what caught your attention, looking for injustice done to your family, to your tribe, to your nation ever after. You are an extremist when it comes to justice, and you won’t stop until justice is done. I think I put you on the wrong track when blaming the unjust treatment you received from your father on him and his family having been ethnically cleansed from East Germany.”

I feel that I have to intervene; though there might be something to it, it surely isn’t all her fault.

“Until I turned 19, I had no desire to do any historical studies, not to mention research. I actually hated history at school. So I think you are

basically off the hook here. This impulse came from elsewhere. It came from the East German student fraternity I was a member of, from being held back in a Czech prison, from the insights into the power games in German society using falsified German history as a weapon. And I also think that my extreme sense of justice and my sincerity and honesty, combined with my strong will, are something that lies within my nature. I do not believe that things would have turned out differently even if I had not had your Catholic morals around for most of my life.”

A few days later we part, not knowing that the next time I will see my son will be in summer 2004, and my daughter a year later, when she will be almost 11 years old.

Two months later, in October 2000, I apply for political asylum in the U.S. And this will be the last time I will ever trust authorities again.

INS # A 78 66 00 16, Case Pending.⁵⁸⁸

⁵⁸⁸ This case was closed in early 2006: Asylum rejected; dissident deported to Germany and promptly imprisoned, thereafter kept in custody for a new indictment, tried, sentenced and again imprisoned; finally release on July 5, 2009, but I am skipping ahead...

4. Flaws of a State under the Rule of Law

Introduction

Where politics and the *Zeitgeist* exert heavy pressure on justice, one must expect that unjust judgments will be handed down on purpose. For this there is no need either for a state with a constitution which is openly contrary to the rule of law or a condition similar to civil war. With respect to normal prosecutions of criminals, the legal procedures of nations observing the rule of law and those not observing the rule of law are similar. Only in politically motivated prosecutions will it show whether or not judges follow the rule of law, that is, whether they can be forced by trial procedures not to deviate from it. For some time there has been a discussion as to how far the character of the Federal Republic of Germany, as a nation observing the rule of law, has been endangered by certain phenomena of the *Zeitgeist*.

One case in particular caused severe accusations from many sides of the German society, so that the political distortions within the German legal system have indeed reached such a degree that even legal experts are seriously troubled: In 1991, Günter Deckert, then leader of the German nationalistic party NPD (Nationaldemokratische Partei Deutschlands), organized a convention where Fred. A. Leuchter, a U.S. expert for execution technologies, lectured about his technical and chemical research regarding the alleged “gas chambers” of Auschwitz. Deckert translated his speech for the audience into German. He was subsequently prosecuted for this and eventually sentenced to 12 months on probation. Following a huge media-outcry and massive intervention of national as well as international politicians, Deckert was put on trial again – at a different court with different judges – and sentenced to two years without probation.

His first judge, Dr. Rainer Orlet, was threatened to be prosecuted for violating the law – his sentence was considered to have been too mild – but was eventually only forced to retire.⁵⁸⁹ Deckert’s publication about this affair,⁵⁹⁰ together with other “thought crimes” like writing naughty letters to Jewish representatives and selling prohibited revisionist literature – were prosecuted as well and, together with his first conviction,

⁵⁸⁹ See G. Herzogenrath-Amelung, *Expert Report*, www.germarrudolf.com/persecute/docs/ListPos93_e.pdf.

⁵⁹⁰ Günther Anntohn (= Günter Deckert), Henri Roques, *Der Fall Günter Deckert*, DAGD/Germania Verlag, Weinheim 1995 (District Court Mannheim, ref. (13) 5 Ns 67/96).

led to an accumulated prison term of more than five years. Eventually, even his defense lawyer Ludwig Bock was prosecuted and sentenced for too vigorously defending Deckert by asking for permission to introduce revisionist evidence. This was considered criminal behavior because Bock allegedly indicated with this that he identifies himself with revisionist thoughts.⁵⁹¹ In a similar case, the late German right-wing defense lawyer Jürgen Rieger was put on trial in 2000, because during the proceedings against one of his clients in summer 1996, he had filed a motion to introduce me as an expert witness as evidence for the fact that his client's revisionist claims were well founded. Though Rieger was initially acquitted by the Hamburg District Court,⁵⁹² the German Federal Supreme Court subsequently overturned this verdict, demanding the sentencing and punishment of every lawyer who dares to ask for, or introduce, evidence challenging the common "knowledge" about the Holocaust.⁵⁹³ Thus, it is clear that every judge who dares to hand out lenient sentences to revisionists at least risks an abrupt end of his career, and defense lawyers trying to defend their clients effectively may themselves be prosecuted for that.

In what follows, I shall show by my own experience which indicates that the rule of law in the German state has many flaws that make it easy for the judicial system in general and the judges in particular to deliberately make bad decisions uncorrectable, because they have the appearance of being decided according to the rule of law.

Again and again in various sorts of company I encounter the same disbelieving astonishment as to the state of the German criminal justice system at the beginning of the prosecution avalanche against me. Despite my lack of formal qualification, I believe I have been called upon to raise my voice on this subject, since the numerous formal defects of the German legal system have apparently not been dealt with by those with the professional competence to do so.

Since I am no legal expert but only one who has been self-educated on the subject through painful experience, I hope readers will excuse my ineptness of expression. If I make frequent reference here to my trial

⁵⁹¹ *VfjG* 3(2) (1999), p. 208. As a consequence of his prosecution, Bock subsequently changed his defense strategy, and when assigned to defend the Australian revisionist Dr. Fredrick Töben in November 1999, he remained completely silent in order to prevent further prosecutions, hence rendering any defense of Dr. Töben impossible.

⁵⁹² *Hamburger Morgenpost*, Nov. 14, 2000; see "Verteidiger Rieger siegt in Verfahren wegen 'unzulässiger Verteidigung,'" *VfjG* 4(3&4) (2000), p. 457.

⁵⁹³ German Federal Supreme Court, BGH, ref. 5 StR 485/01; see German daily press from April 11, 2002 (*taz*, *Bild*, *Frankfurter Rundschau*, *Stuttgarter Zeitung*, *Frankfurter Allgemeine Zeitung*, all on page 2!).

before the District Court of Stuttgart (ref. 17 KLS 83/94), it is because these examples serve to indicate major problems in the German system of government and its judicial system.

No Word-For-Word Record

Until the end of the 1970s, a record of the proceedings was kept during German criminal trials, in which the statements of witnesses and responses of the defendants were set down. The contents of this record were never relevant for an appeal or revision. For example, if in the record it said “The witness said A,” but in the decision the court stated “The witness said B,” the assertion in the decision would be taken as the fact and that in the record would be considered meaningless.

In the course of a change in the German criminal law at the end of the 70s, the duty to make entries in the record of the proceedings was removed for reasons of economy for all courts higher than the county courts. What appears now in German trial records is something like “The witness made statements on the subject” or “The defendant made a declaration.” The substance of what was said cannot be found there and it can no longer be proven by documentation when the court uses statements incorrectly.⁵⁹⁴

In other nations observing the rule of law, such as the United States, Canada, Australia, or Austria, word-by-word transcripts of the proceedings are prepared.

The anti-justice consequences of the present German system can easily be imagined, and I will briefly illustrate it with three examples from my own trial.

1. The issue in this trial was whether or not I had participated in the distribution of a version of my expert report with added commentary by Generalmajor O.E. Remer in April 1993. The court was interested in, among other things, how Remer had come into possession of that par-

⁵⁹⁴ There is always the possibility that the defense can hire its own stenographer to record the proceedings and type them up later. Then there would have to be a motion to insert this record into the record of the proceedings. Motions of this sort are always denied because the German Code of Criminal Procedures does not provide any rules for such records. In order to defeat the usual refusal of the court to accept such a motion on the grounds that the transcript is factually incorrect, the motion would have to be made either before the dismissal of the witness or immediately after the response of the defendant or the defense attorney. Thereby the doubts of the court could be allayed through questioning of the witnesses or the defendant. Although the record of the statements can be entered into the record of the proceedings with the (denied) motion in this way, they will still be irrelevant in appeals and revision procedures. Considering the expense to the defendant in time and money of such an effort over the course of, say, a thirty-day trial with twenty witnesses, it should be clear how impractical this scenario is.

ticular version of my report which he used for producing his printed version. In the trial I had stated that Remer had probably received it from his attorney Hajo Herrmann. The court was more than eager to nail me as a liar, so they were trying to make Hajo Herrmann concede that he never sent a copy of this particular version to his client. Remer had reproduced the “second version of the 3rd edition” of my report, which the court called version “F2.”⁵⁹⁵ In the trial report made by an observer, the questioning of Herrmann on December 6, 1994, ran somewhat as follows:

“Then the witness Hajo Herrmann, year-of-birth 1913, was questioned. He confirmed that in the summer of 1991 he had assigned the preparation of the expert report to the defendant (Germar Rudolf). The witness states that he had received every version of the expert report from the defendant and had sent a copy of each to his client Remer. Later the witness stated that he did not know whether he had received another expert report in November or December 1992. When the judge inquired about it further he said that he could almost exclude this. He also did not believe that he had provided Remer with a new version of the expert report during the appeal to the Federal Supreme Court. Later, Herrmann said that the first version of the 3rd edition sent in November 1992 was the last that he had received. When the defendant (Germar Rudolf) interrogated Herrmann (which the judge at first objected to) whether the witness thought that the arrangement of the chapters of the first version of the 3rd edition was correct, the witness remembered that he had requested a change by telephone. At that point the witness decided that he must have received the second version of the 3rd edition that had been changed due to his request [this was the version called “F2” by the court, which Remer used to produce his published version]. Herrmann could also not exclude that Remer might have obtained documentation with new versions of the expert report during the appeal to the Federal Supreme Court. He said he had submitted the expert report both during the appeal to the District Court and during the appeal to the Federal Supreme Court. At this moment, the presiding judge interjected that the expert report was not to be found in the records of either of these proceedings. Made aware of the error of his statement, the witness said that due to the voluminous material in the numerous trials in which he was involved he was not able to pay such particular attention to any one document, hence he could not remember every single one. In the course of time he had been involved in 12 to 15 trials in which he used Rudolf’s expert report, in addition to all his other trials. For him, the witness, the expert re-

⁵⁹⁵ The first edition was mailed out in some 15 copies in January 1992, the second in February 1992, the first version of the third edition in November 1992, and a slightly revised version of this edition (second version) in December 1992, each numbering some 20-50 copies only.

port of the defendant was just one document among many others and so he was not able to remember details.”

What can be seen from this is that the witness Herrmann was basically confused and could not remember details about which version he had sent to whom and when. But at least Herrmann remembered clearly that he had requested changes to the expert report, so he concluded logically that I must have sent him copies of this rearranged version; after all, I had prepared this version on his request. The court, however, described the statements of the witness on page 199 as follows:

“The taking of evidence has shown on the other hand that attorney Herrmann never, and in any case not during 1992 nor in the first quarter of 1993, had come into possession of draft ‘F2’ and that he did not send it to Remer. The witness Herrmann affirmed that the draft ‘F1’ was the last version of the ‘expert report’ that had come to him, and in addition he could not say when he came into possession of this version. In the rest, he believably reported that he had had no further contact with Remer after the trial in Schweinfurt on Oct. 22, 1992, due to the ‘expert report.’ He could not remember having sent a copy of the ‘expert report’ to Remer in December 1992.”

The difference between the two texts is obvious: The independent observer reported that Herrmann did revise his initial statement after I made him remember that it was Herrmann himself who made me prepare this particular version “F2,” which leads to the logical conclusion that he did, of course, receive at least one copy of this version he had specifically demanded. But the court simply “forgot” about this detail. From its own faulty reasoning, the court concluded on page 202f.:

“The fact that the defendant knowingly spread an untrue account of how the Remer operation came about is a particularly clear indication that he was involved in the Remer operation.”

2. The court was also eager to try to prove that I did tell my sister about Remer’s commentary before Remer had even started to distribute my report, which would have been possible only if I had been involved in the production of said commentary. The first copies of my report mailed out by Remer arrived at their destinations briefly after Easter 1993. If I had told my sister already before Easter about these comments, then this would put a “nail into my coffin.” According to the above-mentioned independent observer, the sister of the defendant made the following statement on January 24, 1995:

“The sister of the defendant states that she learned from her brother during a visit shortly before Easter 1993 (April 10-12, 1993), that Remer had joined a racist and anti-Semitic commentary to the expert report, which

he had obtained from his attorney, and distributed it against his will. In this connection there was talk [between my sister and me] of a measure against Remer at one time. The inquiry, whether her brother described the Remer operation as a threatening event or as a completed happening, she could not answer because she could not remember. It was possible that the operation had already happened. Actually she had spoken with her brother on this subject numerous times since there had been telephone communications between them once a fortnight. Under intensive questioning by the court about details of content and chronology of the events at that time, the witness appeared stressed and appreciably abashed. On inquiry of her brother she said she could no longer remember exactly when she had heard what news from her brother on this subject. She could only describe her overall impression.”

The court described this witness statement as follows (p. 210):

“Moreover the sister of the defendant said he had expressed to her already in Easter 1993 (April 11/12, 1993) the intention to follow the Remer version with an ‘authorized’ version. The reason he had given was that Remer had scattered racist expressions through the ‘expert report.’ But in his testimony the defendant says he saw the Remer version first from his doctoral supervisor on 16th April 1993 and first knew of the Remer additions at that time. The fact that he referred to Remer’s ‘racist expressions’ previous to this is a further indication that the defendant had knowledge of the Remer operation beforehand.”

However, according to the independent observer, my sister thought “it was possible” that Remer’s mail-out had already taken place before Easter 1993, which is clearly incorrect – all copies of Remer’s version were mailed to their recipients only after April 15, 1993. This proves that my sister’s memory was wrong regarding the chronology, which is also supported by her own statements under intensive inquiry both by the judges and by me that she simply could not remember when she had heard what from me. The fact that the witness could no longer remember the exact chronology was duly omitted by the court for obvious reasons. Who of us can remember, down to the exact day, what we heard from our siblings two years ago? But for the court, this was a major stepping stone to its verdict.

3. Another way to prove me a liar was the court’s attempt to prove that my statements regarding contacts with the Remer couple were a lie. By showing that I was hiding my contacts to Remers, they sought to prove that I was in fact involved in their plot to hide the truth from the court. On my contacts with O.E. Remer, the independent observer wrote the following on the trial day November 11, 1994:

“At that point he [the defendant] mentioned among other things his four meetings with O. E. Remer, of which the last took place at the beginning of May 1993. At this time, he had negotiated a declaration of injunction with Remer through an intermediary. The intermediary had rephrased it and given it to him, the defendant. Shortly thereafter, Remer had signed it in the presence of the intermediary and himself. When asked, why he had not handled the declaration of injunction himself, the defendant explained he had not had any contact with Remer and did not desire to do so.”

For January 24, 1995, one reads there:

“Next was introduced an application form to participate at a revisionist gathering in Roding in summer 1991, organized by O. E. Remer, which had been filled out by the defendant but not sent in. The defendant said he had been interested in the proceedings because of the announced participants Prof. R. Faurisson and Dr. W. Stäglich. In any case, he was not there, which is also proved by the fact that he had not sent in the application form. He had not noticed at the time that Remer directed the proceedings.

The defense attorney said that he had himself participated in this gathering but could not remember that he had seen his present client there.”

But the court portrayed both happenings, which it interpreted as evidence of my lack of credibility, as follows (p. 148ff.):

“For one thing he [the defendant] took part in the closed revisionist proceedings called by Remer on 29 June 1991 [in Roding], in which Remer gave the welcoming address (p. 49). The copy of the filled out application form that was found at his house shows that. The defendant has not contested this. [...]

In addition, he finally admitted to have stopped by Remer’s place in Bad Kissingen on May 2, 1993, together with Philipp in connection with the completion of the declaration of injunction (p. 124). The defendant at first attempted to disguise this contact. In his first response during the trial, when talking about how this declaration evolved, he said he had communicated with Remer ‘through an intermediary’ after the latter had not responded to his written warnings. This intermediary had worked out the text of the declaration with Remer and had given it to him. As reason for having made use of an intermediary he said he did not want to have direct contact with Remer.

The defendant attempted to deliberately misrepresent his attitude to Remer in other cases as well. The above-mentioned letter of the defendant to attorney Herrmann on Dec. 20, 1993, shows this. [...] At the same time the defendant described [in this letter] the supposedly only three meetings with Remer. [...]

It is noteworthy that his letter to attorney Herrmann deliberately describes his relation to Remer incompletely by leaving out both of these events [revisionist gathering in Roding and arranging publication of the

brochure *Die Zeit lügt!*,⁵⁹⁶]. *The chamber is convinced from this that it does not reflect the true relations and the actual opinion of the defendant on Remer, but was written expressly for the purpose of misleading the investigation process.*”

Since the original of the application form to the revisionist gathering in Roding had been introduced as evidence during the trial and not a copy, as the court falsely claims in its written verdict, it is easy to see that I was not present at the gathering in Roding. In a later publication, my defense lawyer confirmed the report of the independent observer and criticized the court harshly for this rather odd mistake.⁵⁹⁷ One can see even further that the report of the independent observer is correct with respect to my responses. If one considers that Remer was absolutely not involved in arranging the publication of the brochure *Die Zeit lügt!*, i.e., that it did not lead to any correspondence or meetings between Remer and me (not even the court claimed that), that it was not me who decided to put Remer’s name and publishing house on the imprint of the brochure,⁵⁹⁸ and that in the letters and statements quoted by

⁵⁹⁶ “The (German weekly) Time lies!”, edited by O.E. Remer, Verlag Remer Heipke, Bad Kissingen 1992; revised in G. Rudolf. C. Mattogno, *op. cit.* (note 58), pp. 71-112.

⁵⁹⁷ G. Herzogenrath-Amelung, *op. cit.* (note 589), pp. 186f.

⁵⁹⁸ This brochure was mainly written by me (under four pen names), but made fit for publication by Karl Philipp, who made some changes to it and chose Remer as editor and publisher to protect me legally (which worked). As far as I know, Remer was not involved in the actual production of the brochure, and I was never involved in its distribution. Therefore, no link ever existed between my writing the brochure – without any intention to do it for Remer – and the fact that Philipp put Remer’s name on it (probably even without Remer knowing it) after I had finished my writings. True, I never complained about it, but there was, realistically seen, no other way than Philipp’s way to have this brochure published swiftly – which was necessary since it was a reaction to a series of articles in a weekly newspaper – and I did not intend to reveal my pen names to anybody anyway, so why bother?

It should be mentioned in this context that this brochure still causes me some trouble in that my use of four pen names for it (Dipl.-Ing. Hans Karl Westphal, engineer; Dr. Werner Kretschmer, barrister, Dr. Christian Konrad, historian, Dr. Dr. Rainer Scholz, chemist and pharmacologist), all of them pretending to have a different academic degree, led to the accusation of dishonesty and attempted confidence trickery (see, e.g., www.holocaust-history.org/auschwitz/chemistry/not-the-science/). The background of these pen names was not an attempt to impress people with phony doctorates, though I must admit that it can have this effect. I therefore wish to set the record straight by repeating what I stated already elsewhere (www.vho.org/GB/c/GR/CharacterAssassins.html):

The brochure *Die Zeit lügt!* was the first revisionist publication I was involved in. It was a reply to two lengthy articles of a certain Till Bastian published in summer 1991 in the German weekly *Die Zeit* (no. 39, Sept. 18, 1992, p. 104, and no. 40, Sept. 25, 1992, p. 90). This brochure is the fairest writing about the Holocaust controversy that ever appeared, simply for the reason that both articles of Bastian were reprinted *in their entirety*, and discussed afterwards. The reader always has the means to check both points of view. Nobody else has ever done that before or since – on either side of this discussion.

Nowhere in that brochure is reference made to the special expertise and qualifications of the authors given – simply because these names were added after the brochure was written – nor would the claims and arguments brought forward in this brochure require the qualifications of

the court I was always writing and speaking about actual dealings with Remer – there was none in connection with the brochure *Die Zeit lügt!* – it must be asked: who lacks credibility here?

A large number of similar cases could be shown in which the court made observations on the statements of mine or of witnesses that differ from the trial report. Since the differing interpretations of the court were always disadvantageous for me, the question must be raised whether we are supposed to believe that these errors were made unintentionally.

Hiding the Purpose of Evidence

It appears possible that in German courts, the written judgment will suddenly present evidence as the main proof of guilt which had remained in the background during the proceedings of the trial, in that the court reinterprets it in a way that had not been mentioned during the proceedings. In this way, it is impossible for the defense to bring in evidence to refute evidence which at first appears to be harmless since no one can tell what evidence the court will use as proof of what fact.

When the defense attorney wants to introduce a piece of evidence, he must always provide a reason for it so that the court can decide on the request. On the other hand, this rule does not seem to apply to the court itself.

Here is one example of that. The court interpreted certain publication details of the original version of the Rudolf expert report used by Remer in his version as well as of the version without comments pub-

these experts. Though it was certainly incorrect to do this, I would like to explain why it was done, as it was certainly not done in order to claim qualifications that are actually not present. Let me therefore be a bit more detailed.

In spring and summer 1992, I was called by several defense lawyers as an expert witness in several trials imposed on revisionists in Germany (Udo Walendy, District Court Bielefeld, February 1992; Gerd Honsik, Upper District Court Munich, March 1992; David Irving, County Court Munich, May 1992; Detscher, County Court Munich, July 1992; Max Wahl, District Court Munich, July 1992). In these trials – as in all trials against revisionists – the judges rejected any evidence presented by the defense, including all expert witnesses. In one case, I had to learn that a chemist (me) was rejected because he was neither a toxicologist nor a historian, an engineer (Leuchter) was rejected because he was neither a chemist nor a historian, and a historian (Prof. Haverbeck) was rejected because he was neither a chemist nor an engineer. My conclusions were that one obviously had to be at the same time an engineer, a chemist, a toxicologist, a historian and perhaps even a barrister to be accepted as an expert witness at a German court of law. The legal process being so perverted in Germany, I decided to mock it with a parody by inventing a person with all these features, but then Karl Philipp and I realized that this would be a bit unrealistic, so we split that person into many. That is the background. I think it is both tragic – for the victims of those German kangaroo trials – as well as funny – for the neutral observer to see the desperate attempts of German judges to keep any evidence out – , but the reader does, of course, not have to agree with me on that.

lished by me a few months later as proof that Remer's distribution activities of his version and the subsequent publication of my authorized version were one single operation planned in advance. As one of the main proofs for this the court pointed to the fact that in the draft of my expert report produced in November 1992 (version F2), Prof. R. Faurisson had not been mentioned in the acknowledgements at the end of the report. He had first been expressly thanked in the authorized version of my expert report published in July 1993 on the inner cover. According to the court, this allegedly proves that the authorized version was planned already in November 1992 (decision, pp. 93, 208ff. Don't try to find logic in it. There is none.). It did not enter the judges' minds that I had deleted the acknowledgement to Faurisson from the November 1992 version simply because I feared to be rejected as an expert witness, should any court recognize that I had been in contact and on good terms with the world's leading revisionist, and not because I already planned to thank Faurisson later in a prominent place in the authorized version. The whole argument spun around this point about the acknowledgement, which first surfaced in the decision and was based on different versions of the expert report that had been introduced as evidence, had never been mentioned even peripherally in the 29 days of the trial proceedings, so that the defense was unable to bring in any evidence to counter this supposed evidence proving the guilt of the defendant.

Introduction of Evidence After the Verbal Decision

It is doubtful whether the introduction of evidence following the trial is admissible. Nevertheless, the District Court of Stuttgart used exactly this method in order to portray me as untrustworthy. As supposed proof that I had manipulated witnesses, on page 170f. of its decision the court stated:

"Further, during a search of his living quarters on March 27, 1995, which took place in the context of an investigation conducted by the state attorney of Tübingen on the book 'Grundlagen zur Zeitgeschichte,' another computer belonging to the defendant was found on which there was an answer list that concerned the interrogation of the witness Dill by the court, as the defendant himself declared in the trial."

First, the description of the court is misleading, since I had only declared that my computer had been seized, but not that an answer list had been found on it. This document had been mentioned by the court in the trial but it had not been introduced as evidence in the trial. For this reason, the defense attorney did not think it necessary to produce evidence

to oppose this imputation, which might have explained that the item was not an answer list intended for use in an upcoming questioning of a witness. In fact, it was a detailed record I had prepared about what Dill was asked and what he answered when he appeared for the first time in front of the court, and this list was prepared *after* this interrogation, hence could not be used to manipulate this witness at all.

Refusal of Foreign Witnesses Without Reason

In the middle of the 1980s, the German criminal justice system was altered so that motions could effectively be denied to hear the testimony of foreign witnesses in their own country. In the course of the trial concerning Remer's distribution of my report, it became obvious that several foreign revisionists had participated in the operation indirectly or directly. Since these revisionists faced the possibility of arrest if they traveled to Germany, due to their revisionist activity, they would have had to give their testimony outside the country. Because of the reformulation of the German law, however, it was possible for the court in the final phase of the trial to deny numerous motions of the defense that were intended to hear the testimony of foreign witnesses outside the country on key questions. The effect this can have on the judgment is obvious.

Prevention of Appeal

In criminal proceedings caused by crimes that are considered by the German authorities to have caused major violations of law and order, the trial is held immediately on the district court level, *i.e.*, on what normally is supposed to be the appeal level (the first level is the county court). In such cases, the defendant has only one trial during which evidence can be presented, that is, there is no appeal possible to the verdict of this court! Only a so-called application for a revision of the verdict with the German Federal Supreme Court is possible, but such an application can only criticize errors of form (matters of law). The factual assertions of the deciding court, *i.e.*, description and evaluation of evidence (matters of fact), will not be discussed anymore. Furthermore, it is usually the case that applications for a revision will be denied by the German Federal Supreme Court, if the defense is the only party to request it.

Whoever determines, and on whatever basis, whether or not law and order have been seriously violated by an offender, must remain open. But such a serious violation seems to be always given, if the offense involves massive attacks on political taboos. In such cases – where the defendant’s entire existence is at stake – he has no possibility of reopening the taking of evidence in an appeal.

The fact that recent attempts were made in Germany to deny an appeal even for trials of minor misdemeanors held before county courts for the sake of relieving the workload of the courts, shows how little room for maneuver is left to him who gets caught up in the wheels of German justice.

The Arbitrary Evaluation of Evidence

Even if a court has introduced evidence in the course of a trial that made its delicately constructed bridge of circumstantial evidence to collapse by refuting it, this is no reason not to impose a sentence. Here is an example.

In my case, the court had come up with the idea that, already in October 1992, I had planned Remer’s distribution activities of his version and the subsequent publication of my authorized version as one single operation planned in advance (decision pp. 207ff.).

At the same time, on Feb. 16, 1995, the court introduced a letter of mine to the then director of the Institute for Historical Review, dated May 22, 1993, from which it was clear that up to the end of May 1993, a month after the end of Remer’s distribution operation, I still did not know where I could publish my authorized version of the expert report, which indisputably contradicted the court’s thesis that I was already planning to publish the authorized version at the same time as I was allegedly helping to plan the Remer operation.

Here is a second example of the court’s logic-free evaluation of the evidence. In its written verdict, the court conceded that I intended to get the attention of the lay public for my expert report (decision pp. 23f., 108f., 210), so that I had paid attention that there was no reason for the general public to suspect any lack of technical merit and reputation, *e.g.*, by including political comments (decision pp. 17ff., 196f., 218). This was supported by the evidence as a whole and in particular by the documents introduced on June 13, 1995, which were a series of letters that I had written to various persons between 1991 and 1993, all clearly stating that I did not want any political or polemic comments included

in or associated with my expert report. However, if one was to follow this logic, one has to assume that I would have sent out – or agreed to the distribution of – a version of my expert report which confined itself to technical discussion but would *never* have sent out one such as the Remer version with its polemical/political commentary. In the decision the court can escape this logical contradiction only by claiming that I had miscalculated the effect of Remer’s commentary (p. 228).

Incriminating Mitigating Evidence

Having arrived at a verdict in this way, the tens of pieces of exonerating evidence – documents and witnesses – that my lawyer had introduced served the court as evidence of my “criminal energy,” since, according to the court, this exonerating evidence was all partly made up (decision pp. 13, 22, 65, 118-126, 131, 175, 192) and served only to deceive the court:

“The culpability of the defendant is even greater when one takes note of the high criminal energy with which the crime was committed. The defendant acted on the basis of a calculated and highly refined strategy carried out in a hidden manner that was chosen beforehand with great deliberation, involved numerous deceptions and manipulations and was therefore very difficult to penetrate.” (decision p. 237)

Which leads to the court’s conclusion:

“The sentence of imprisonment is not subject to probation, by sec. 56 of the Criminal Code (StGB).” (decision p. 238)

since:

“On the contrary, [the crime of the defendant] as described, because of the calculated and refined and clandestine manner in which it was carried out, should be seen as particularly grave.” (decision p. 240)

Conclusions

Given the present circumstances of the criminal justice system in the Federal Republic of Germany, when a judge or a panel of judges intends to render an unjust verdict, they will have no difficulty in doing so as long as they are assured there is no organized public resistance from the media, academia, the police, or the churches.

The statements of witnesses and defendants may be manipulated at will. Evidence may be interpreted any which way in the decision or may be brought in after the process is over. Submitted evidence may be

passed over without mention and use of foreign witnesses may be denied arbitrarily.

Exculpatory evidence may be discredited as a deceptive maneuver of the defendant and serve as evidence that the defendant is particularly deserving of punishment. A second trial to try to correct these measures can be denied in case of public necessity. The evaluation of evidence is bound neither by the evidence introduced nor by logic.

The question, how these conditions can be overcome so that further misuse can be reduced as much as possible, needs to be answered by honest jurists and politicians.

Closing Remarks

The court based its refusal to allow for a probation of the sentence of imprisonment not only on my supposedly high “criminal energy,” but also on the fact that I did not seem to have a favorable social prognosis, since I had not only not repudiated my revisionist views, but defended them even more vehemently and kept propagandizing them. As proof for this the court pointed to the book *Grundlagen zur Zeitgeschichte*,⁵⁹⁹ edited by me under a pen name, which had come onto the market just at the beginning of this trial, as well as to the almost-complete book *Auschwitz: Nackte Fakten*⁶⁰⁰ found on my computer during a house search conducted in March 1995, *i.e.*, right in the middle of the ongoing proceedings.

With this, a fact was used to harden my punishment that had not even been determined to be a criminal offense in a legally binding decision by a German court in the first place, as was a work which had not yet been published and which therefore could not even theoretically have been a crime. By German law, it is admissible for a German criminal court to take account of the opinions of the defendant – here my historical revisionist opinions – in the weighing of punishment. Through this back-door, the trial against me was turned into a political trial.⁶⁰¹

⁵⁹⁹ Engl.: *Dissecting the Holocaust*, *op. cit.* (note 24).

⁶⁰⁰ Engl.: G. Rudolf (ed.), *Auschwitz: Plain Facts*, *op. cit.* (note 96).

⁶⁰¹ This article was completed after the house search of the small Berlin publishing house *Verlag der Freunde* at the end of November 1995 (triggered by a revisionist article of mine they had published), when it had become clear that the documentation of my trial intended to be published by this publisher could not appear; taken from *Staatsbriefe* 1/1996, Verlag Castel del Monte, Postfach 14 06 28, 80456 Munich, pp. 4-8.

5. Rudolf's "Thought Crimes"

5.1. The First Crime: Remer's Commentary

Reprinted below is the commentary of retired Major General Otto Ernst Remer, which he included in his version of the Rudolf expert report, as it was printed on pages 109a to 114 of the court decision against Gernar Rudolf.⁶⁰² After reading this chapter 11 so far, readers should be in a position to judge whether this commentary was sufficient cause to sentence expert witness Gernar Rudolf to 14 months of incarceration, had he agreed to the inclusion of these commentaries, which he had not, though the Great State Security Chamber of the District Court of Stuttgart disregarded the evidence and said he did.

On Jan. 19, 1996, the German attorney general demanded that Gernar Rudolf should spend 14 months behind bars for nothing other than this commentary. The German Federal Supreme Court concurred with this demand in a decision on March 7, 1996 (ref.: 1 StR 18/96).

In addition to these judicial issues, there were other problems with Remer's commentary. In his preface printed on the inside front cover, under the caption "To all friends, countrymen ..." he attacked our leading politicians, media people and jurists harshly with the words, "These liars need to be driven from their spoils fortresses." At the same time, Remer mailed this version to exactly these leading politicians, media people and jurists. It is certain that to send such a piece of writing to these leading politicians, media people and jurists was entirely useless – though it must have cost many thousand DM.

Remer attached a comprehensive five-page article on the October 1992 trial, in which Remer himself had been sentenced to a 22 months prison term for denying the Holocaust and other things. This article was written by a close friend of Remer who had attended Remer's trial. It basically summarizes the major events of this trial, like a description of various pieces of evidence presented by the two defense lawyers, their rejection by the court, and the final pleadings of the public prosecutor and Remer's defense attorneys. The Rudolf Report had been prepared for this and for other trials.

In the trial against expert witness Rudolf, the District Court of Stuttgart took exception against this article, which had been entitled "Justice

⁶⁰² For this version, the text of Remer's comments were retyped, trying to keep the layout as close to the original as possible. The original German version of this is available online at www.vho.org/D/Kardinal/Remer.html.

in Germany 1992.” For example, they criticized that the quotation from the Foreign Office saying that it was known that there were no gas chambers in Auschwitz (p. I) was incomplete, as the ellipses showed. The quoted German official Dr. Scheel had stated later in his letter that the gas chambers had been located in the Birkenau camp which was 3 km to the west. Thus he had not denied the existence of gas chambers in the complex Auschwitz-Birkenau, as the quotation suggested, but only with respect the main camp Auschwitz. This determination of the court is correct and demonstrates that Remer’s friend misconstrued documents to mislead the public. However, it should be pointed out that the statement of the Foreign Office that there had been no gas chambers in Auschwitz contradicts many witnesses, such as Pery S. Broad or Rudolf Höß. If these witnesses were wrong with their statements about the main camp Auschwitz, how can we be certain that other witnesses to other camps were not just as wrong? How can it be that under such circumstances to doubt the existence of gas chambers in other camps, or even to dispute their existence, is a criminal offense?

The District Court of Stuttgart also commented that the “Comparison of official figures on the number of those killed in the gas chambers in Auschwitz” (p. II) was insulting and constituted incitement to racial hatred. But in the meantime, quite official and well reputed sources have added even lower figures to this list of massively differing numbers: in 1993 and 1994, the French pharmacist Jean-Claude Pressac claims between 630,000 and 470,000 “gas chamber” victims, and in 2002, a German mainstream journalist reduced the death toll of the Auschwitz “gas chambers” down to as little as 356,000.⁶⁰³ One could certainly agree to the view that any number of victims which is too high or too low can have an insulting effect on some people or can incite to hatred against others. However, it was not Remer who had put these widely differing figures into the world, among which only one can be correct at best – and all others potentially inciting to racial hatred.

Also, Remer’s statement that the Frankfurt Auschwitz trial had determined that there were only 45,510 deaths in the gas chambers was not strictly true. In 1965, the Frankfurt Jury Court had sentenced some of the former camp staff on grounds of murder of a certain number of people by poison gas, and for other reasons. All told, it repaid 45,510 gas chamber murders in that it found some defendants guilty of having killed or contributed to the murder of a certain number of inmates. As to the question, how many prisoners had been killed by poison gas in

⁶⁰³ See notes 472-474.

Auschwitz all in all, the court had given no answer and did not have the duty to do so. The determination of the total count of victims is properly a scientific question. That having been said, this would also mean that the Stuttgart Court did not have the duty nor the competence either to make a judgment about the total death toll of Auschwitz, that is, it should not have criticized others for asking questions and having different views in this regard.

It remains true that German justice has judicially determined a figure of 45,510 gas chamber deaths, no more, no less, and that anything more is a scientific question and not a question of criminal justice. It must be asked then, why one should proceed against people with threats of criminal penalty and use of the magic formula “common knowledge,” who do nothing else but to assert that counts of victims as high as several hundred thousand or even several millions are greatly exaggerated, particularly since several well-known mainstream authors do make similar statements. Only that can be judicially claimed to be “common knowledge” which has been determined to be so in court on examination of evidence. With respect to the number of victims of the gas chambers of Auschwitz, that has not been done.

In the written basis for the decision, as proof of their assertion that the epilogue of the Remer version had deliberately created the impression that the Holocaust was used by Jews to exploit Germany, the court gave this one example (decision, p. 235):

“This applies especially to the reprinting of a letter claimed to have been written by a Jew on May 2, 1991 (p. IV of the epilogue, p. 113 above). Together with the assertion that the Holocaust was an invention of the Jews, this deliberately inflames hatred against the Jews.”

In the epilogue in a display box one sees that Remer has quoted a letter with a sender’s address in Israel, in which the writer inquires about financial reparations based on the claim that his uncle was allegedly gassed in the concentration camp at Dachau. That this letter was written by a Jew is not mentioned anywhere, nor is there any reference to the religious affiliation of this person in this article. There is also no assertion in Remer’s (or his friend’s) comments “that the Holocaust was an invention of the Jews,” quite contrary to what the court claims. All that Remer’s friend did was to juxtapose the letter from Israel with a letter from the City of Dachau, in which the latter clarifies that there had never been any homicidal gassings in the concentration camp at Dachau.

The court had not examined whether or not this letter existed, therefore, on the principle “*In dubio pro reo*,” it had to assume that it did exist. In fact, not just Remer but also many other activists had photocopies of the letter which Remer’s friend had reproduced in the appendix to Remer’s version. It is a fact that there is a large number of statements from witnesses attesting to homicidal gassing in Dachau, but it is also well known that both the official Dachau Concentration Camp Museum as well as the City of Dachau clearly state that there were never any homicidal gassings in this concentration camp.⁶⁰⁴

These well-recognized facts were given with the documents published or quoted by Remer (or his friend), which cannot be a crime. In his commentary on this letter, Remer points out that false witness statements like the one quoted here, attesting to his uncle’s death in a Dachau gas chamber, serve as a basis for “common knowledge” in Germany. Nowhere did he make the claim that anybody had lied for purposes of material enrichment. It is the court that is to blame for the charge that the reader would get the impression from these two reproduced documents, implying that Jews had invented a lie for the purpose of exploiting Germany.

That even Jews sometimes make false statements about the period between 1945 and 1993 cannot be disputed. This was particularly clear in the criminal trial of John Demjanjuk in Jerusalem. The trial ended with an acquittal for the defendant, since even the Israeli court could not shut its eyes to the flood of false documents and false witness testimony.⁶⁰⁵ Fortunately, in this case also, Jewish personalities turned against the flood of untruths that appeared in this trial.⁶⁰⁶

That the same untrustworthy witnesses who appeared in this Jerusalem trial had made similar (incredible) statements in trials in Germany and elsewhere, did not affect their credibility in the eyes of the German court, of course.

In addition, an advertising blitz of the German Jew Aze Brauner and his friends on May 6, 1995, in the German daily newspapers *Frankfurter Allgemeine Zeitung* and *Süddeutsche Zeitung*, rehashed the old lies about soap made of the fat of Jews and lampshades made of human skin. These claims have been repudiated even by the Holocaust Insti-

⁶⁰⁴ There are, of course, other sources contradicting this, see Reinhold Schwertfeger (=Germar Rudolf), “Gab es Gaskammern im Altreich?,” *VjffG*, 5(4) (2001), pp. 446-449.

⁶⁰⁵ Cf. the summarizing article of Arnulf Neumaier, *op. cit.* (note 456).

⁶⁰⁶ Asides from note 605 compare the book of Demjanjuk’s defense lawyer: Yoram Sheftel, *The Demjanjuk Affair. The Rise and Fall of the Show Trial*, Victor Gollancz, London 1994.

tute Yad-Vashem of Jerusalem.⁶⁰⁷ But this did not serve to make our jurists consider that not everything a Jew says about the years 1933 to 1945 is necessarily true.

Even the recently reconfirmed information that the Jew Ilya Ehrenburg, who was Stalin's chief propagandist, was one of the worst deceivers and liars in questions of the supposed National Socialist annihilation of the Jews⁶⁰⁸ does not appear to impress anyone in Germany. On the contrary, the Federal German justice system seems to opine that a Jew always tells the truth and that a non-Jew who accuses a Jew of reporting falsehoods or even lies belongs in jail.⁶⁰⁹

In the decision of the 17th Criminal Chamber of the District Court Stuttgart, there is this discussion on Remer's preface and epilogue (p. 115):

"Although preface and epilogue do not expressly accuse the Jews of having invented the accounts on the Holocaust particularly to gain political and material advantages,"

– read: although the crime of which Germar Rudolf was accused of had not been committed...

"in the eyes of this court the purpose of the Remer-Version of the 'Expert Report' is nevertheless to suggest this"

– read: the judges can read the mind and intention of the defendant...

"and hence to stir up hostile emotions against the Jews. Provided that the claims of the 'Expert Report' are correct,"

– the court did nothing to find out whether or not Rudolf's Expert Report is correct, so it had to assume that it indeed is correct...

"this arises already from the fact that the reader, among others due to the tendentious statements and attitude, had to come to the conclusion that the [...] Jews must have consciously forged the accounts on the Holocaust."

– read: even if the Expert Report is correct, the publisher has to make sure that his readers don't think wrongly, or he will be punished for that, and the judges know the effect of this publication on the reader even without having any evidence for it.

⁶⁰⁷ Shmuel Krakowski, archives director of Yad Vashem, and Professor Yehuda Bauer finally admitted in 1990 that "the Nazis never made soap from human fat," *The Jerusalem Post International Edition*, May 5, 1990; see *JHR* 11(2) (1991) pp. 217-227.

⁶⁰⁸ Joachim Hoffmann, *Stalins Vernichtungskrieg*, Verlag für Wehrwissenschaften, Munich 1995; Engl.: *Stalin's War of Extermination 1941-1945*, Theses & Dissertations Press, Capshaw, AL, 2001.

⁶⁰⁹ As such Helge Grabitz, *NS-Prozesse – Psychogramme der Beteiligten*, 2nd ed., C.F. Müller, Heidelberg 1986, pp. 64-90.

This meant the expert witness was not only punished for a crime that he had not committed, but also for one that no one had committed in the first place. The crime was invented by the court – they ignored the facts and fantasized about what may be written between the lines!

Even though this was Rudolf's first conviction, this sentence could not, according to the court, be suspended (p. 239):

*“if only because no positive social prognosis can be made for the defendant (§56 para. 1. Penal Code), who is to be categorized as a **fanatical, politically motivated criminal**. During and despite of the current trial, the defendant did publish more ‘revisionist’ works or prepared them, **which once again proves his views**. These, too, use the same strategy of apparent **objectivity** to deny the Holocaust. For example, in fall 1994 the book ‘Grundlagen zur Zeitgeschichte’ [=Dissecting the Holocaust, August 2000] appeared, and the book against Pressac was prepared. The court has therefore no doubt that, in regard of the laws mentioned, the defendant is not willing to be a law-abiding citizen.”* (emphasis added)

Here the court openly admits that it sentenced Rudolf to a prison term because of his scholarly convictions which allegedly render him an incorrigible criminal. No more proof is needed to show that Rudolf is politically persecuted in Germany.

Furthermore, the court uses publications, which it had called “scholarly” at the beginning of the verdict and which at that time had not yet finally been declared illegal by any court decision, to justify a prison term without probation.

By the time the judges handed down their verdict in June 1995, Rudolf had published three books. About the first, Rudolf's Expert Report on chemical and technical details of the alleged gas chambers of Auschwitz, the verdict states at page 23:

“This work, the basis of his publishing activities, is essentially written in a scholarly style. It addresses a chemical detail (the problem of hydrocyanic acid) and does not make any general political conclusions.”

In general, the verdict says about Rudolf's three main works (*Expert Report, Vorlesungen zur Zeitgeschichte, Grundlagen zur Zeitgeschichte*):

“They are characterized by a scholarly attitude with reference to his expertise as a scientifically trained chemist. Tone and form are generally held in a way, as if they were interested only in the matter. Additionally, intensive discussions of details, tables and graphs as well as voluminous references to literature are meant to give the impression of an unbiased and open-minded scholarship. This is primarily true for the three large publications of the defendant.” (p. 23 of verdict)

About *Grundlagen zur Zeitgeschichte* – now published in English under *Dissecting the Holocaust* – the verdict says, it includes “a maximum appearance of objectivity” (p. 26), which later was confirmed by two German mainstream historians in expert reports they wrote in support of Rudolf’s scholarly work. Of course, the court had to insert the word “appearance,” to cast doubt on the quality of these works, because otherwise it could not possibly have sentenced Rudolf.

Considering the contempt and hate this verdict shows against Gernar Rudolf, such words of open endorsement cannot be underestimated. Since the court had to admit that Rudolf’s main works are formally scientific and scholarly (form, *i.e.*, appearance, not content, is the only criterion for scholarly works!), the defendant could not possibly have committed any crime by publishing them, since the German unofficial constitution guarantees the freedom of science without restriction in article 5.3 of the German Basic Law. So Remer’s additions were used instead to tie the rope around Rudolf’s neck.

With this finding, the court turned the historical dissident (revisionist) Gernar Rudolf into a “thought criminal.”

It should be pointed out here that in May 2002, Fritjof Meyer, an editor of Germany’s largest, left-wing weekly magazine *Der Spiegel*, stated in a scholarly article addressing the alleged death toll of Auschwitz that the evidence indicates only some failed test gassings for the Birkenau crematoria, but no mass murder on a genocidal scale.³²⁹ This sensational statement is close to the claim Rudolf has been making since 1992, *i.e.*, that “the mass gassings [...] did not take place [as] claimed by witnesses.” Hence, Meyer’s article is nothing short of a partial but timely rehabilitation of Rudolf, and it might take only one or two more revisions of the official historiography of Auschwitz to reach the point where it agrees totally with what Rudolf is stating in his expert report.

I pondered a long time over the question whether or not to reprint Remer’s comments, since they caused me an awful lot of distress. But I think he had a perfect right to say what he had to say, and it was really a scandal how the German legal system persecuted this old man. Though I do not agree with everything Remer and his friend wrote, and much less with their style, I decided to reprint these comments in full, so that the reader can understand, how easily one can get imprisoned in Ger-

many for making, endorsing, or – as in my case – simply being associated with hot-headed, but perfectly legal and harmless statements.

Remer's commentary [Preface]

Otto Ernst Remer, General-major, retired, Winkelser Str. 11E, 8730 Bad Kissingen, Tel: 0971-63741, Fax: 69634

To all friends, countrymen and people who love the truth: I am in distress!

On October 22, 1992, the District Court of Schweinfurt, Judge Siebenbürger presiding, sentenced me to 22 months prison without probation. This is the equivalent of a death sentence for me.

The trial against me was not a real trial. The main session of the trial ended in a deadlock. The sentence was equivalent to the destruction of an 80-year-old man. I was not permitted to defend myself against charges consisting of lies, harassment, and attacks on my honor. The court denied me the possibility of defense by means of sec. 186 of the German Penal Code. It refused to put my assertions to the test of examination.

My defense attorney had asked the expert witness Rudolf to appear. This expert witness was in the courtroom, his expert report had already been submitted along with other official records. However, the expert witness was not allowed to speak and the expert report was not allowed to be read. The expert report and irrefutable scientific facts were denied by presiding judge Siebenbürger.

Earlier, Diplom-Chemist Rudolf had been assigned by my defense attorney, retired Colonel Hajo Herrmann, as expert witness to investigate testimony concerning alleged homicidal gassings at Auschwitz. Rudolf used modern scientific, precise measurement techniques to establish the presence of cyanic residue.

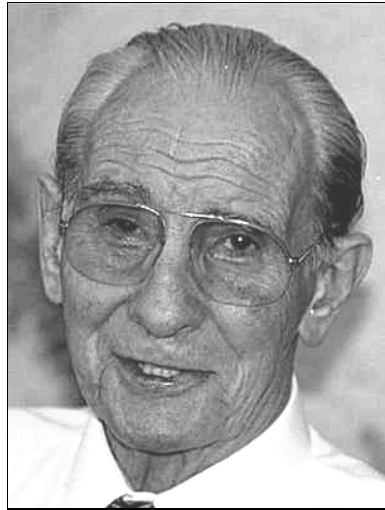

*ret. Major General Otto Ernst
Remer in 1992*

No physical evidence has ever been presented in court to support claims of homicidal gassings: no document, no photo, and no orders from military or civil authorities. Can you imagine that a group of people as large as the population of Munich could be anni-



The masonry samples taken by Rudolf were analyzed by the renowned Institut Fresenius.

hilated without leaving any traces of the crime? The only proofs of mass homicidal gassings are absurd witness statements. In the great Frankfurt Auschwitz trial (50/4 Ks 2/63) the court “proved” the existence of homicidal gas chambers with the testimony of a single eyewitness, named Böck, who reported having seen thousands of Jews killed with Zyklon B. He testified that he “saw with my own eyes” how the prisoners’ commando worked without any protective garment in the midst of this Zyklon B gas, still hovering in blue clouds over the corpses, without suffering ill effects. What is the difference between Böck’s testimony and that of eyewitnesses who confirmed under oath that they saw witches riding brooms on their way to the Blocksberg?

In a powerful and irrefutable scientific work, my expert witness made a shattering discovery: The buildings in Auschwitz which are pointed out to tourists as homicidal gas chambers, in which millions of Jews were allegedly killed, never came in contact with Zyklon B. The analyses were carried out by no less an organization than the renowned Fresenius Institute. Notable historians agree that this research will revise world history.

This expert report has been in the hands of the federal chancellor, the *Zentralrat der Juden in Deutschland* (Central Council of Jews in Germany), the federal attorney general, the Ministry of Justice, and notable scientists and personalities for more than a year. Every one of them remained as quiet as a mouse.

The condition under which my expert witness agreed to testify was that his report should be presented only to the court. He specifically forbade me to make his report available to the public. However, since the Auschwitz Lie has become an instrument which threatens the existence of all Germans, I can no longer allow myself to be bound by this condition.

I myself shall die in prison for publishing scientific facts. By means of an unbelievably satanic twisting of history our people will be held defenseless and “subject to extortion,” as the Association of German

Veterans wrote in its journal *Soldat im Volk* no. 7/8 in 1992. In this condition of eternal abject surrender we shall be destroyed by means of a horrifying “multiculturalism.” This has forced me to a desperate defensive measure, which takes the form of unauthorized publication of Rudolf’s Expert Report on the alleged gas chambers of Auschwitz.

Since 1945, generations of German politicians have not only acquiesced in these ghastly lies against the German nation, they have participated in manufacturing them. The same applies to the mass media. These elements are doing everything they can to propagate the most vicious lies in the history of mankind through the German criminal justice system. When the truth comes to light, these corrupt and venal politicians know that they will be scorned by the public. The media brotherhood know they will be reviled as liars and driven from their posh editorial offices.

This whole pack of liars should be scorned and despised, deprived of position and driven from their spoils fortresses for what they have done to our people. I would like to contribute to this.

You too can help distribute this Expert Report. In the first phase of this operation, I myself will send copies to 1,000 leading Germans. Among them will be leaders of the military, business, scientific, and university communities, in particular members of chemistry and history faculties. I shall send a copy to every representative in parliament as well as media personalities.

In the second and third phases, I shall send another 1,000 copies of this scientific report. No person of prominence will be able to say that he did not know the truth.

These operations will be very expensive since postage alone costs 4 Marks per copy. Therefore I need your support. By ordering a copy of the Expert Report, you will be helping help me to distribute this irrefutable scientific document. Additional contributions will enable additional distribution. I am counting on your help.

Faithfully yours, Otto Ernst Remer

25th October 1992

I have added Sections I-V of the report of my trial in Schweinfurt. After reading this report, you will understand the desperation of my defense effort.

[Appendix]

Justice in Germany 1992: “Death Sentence for General Remer“

This trial report by E. Haller is taken from REMER DEPESCHE no. 6/1992



Kahlenbergerdorf

(Austria), June 2, 1988

Source: Honsik, *Acquittal for Hitler?*

As a Roman Catholic priest I say to you ... question the existence of gas chambers in the Third Reich. It is the right of those who seek the truth to be allowed to doubt, investigate and evaluate. Wherever this doubting and evaluating is forbidden, wherever someone demands that he must be believed, an arrogance arises that is a blasphemy to God. This is why. If those whom you doubt have the truth on their side, they will accept any questions gracefully and answer them patiently. They will no longer hide their proofs and their records. If these are lying, they will cry for the judge. That is how you will recognize them. The truth is always graceful, while lies cry out for earthly judges.

Respectfully,

with best regards,

/s/ Pastor Viktor Robert
Knirsch

Schweinfurt (EH) – On October 22, 1992, the First Great Criminal Chamber of the District Court of Schweinfurt, Judge Siebenbürger presiding, sentenced General Remer for publication of a scientific expert report. The main point of the expert report Remer had published was: there were no mass killings in Auschwitz with Zyklon B. The court called this publication “incitement to racial hatred,” and Siebenbürger imposed on General Remer a sentence of 22 months imprisonment without probation. State Attorney Baumann demanded a 30 months prison term and moved for the immediate arrest of the 80-year old defendant in the courtroom. Observers of the trial began to suspect that the sentence had been decided before the trial began. At 9:00 hours on October 20, 1992, the day the trial opened, radio BAYERN 1 had announced: “*This time it will cost Remer. [...] this time the punishment will be harder.*” How did the announcer from B1 know that General Remer would be punished more severely than in previous trials? Why was an acquittal not conceivable?

This document is one of many that were presented to the court as evidence. Answer: “Denied on grounds of common knowledge.”

GERMAN FOREIGN OFFICE

214-E-Stuparek
Bonn , 8th Jan. 1979

Dear Mr. Stuparek!

Federal Minister Genscher has asked me to respond to your letter of December 21, 1978.

As far as I know, there were no gas chambers in the camp of Auschwitz ...

Best regards,

For the Federal Minister,

/s/ Dr. Scheel

What had Remer done? As editor of the periodical *Remer Depesche* (Remer Dispatches), the highly-decorated front-line officer had published the results of a number of scientific expert reports. One of them was the Leuchter Report, which former Minister of Justice Engelhard described as “scientific research.” Fred Leuchter is a constructor of execution gas chambers that use hydrogen cyanide in the USA. Later, the director of the Auschwitz Museum, Dr. F. Piper, assigned the Jan Sehn Institut in Krakow to make a similar expert report. A technical expert report in German in conjunction with the renowned Institute Fresenius followed in February 1992. The discussion that the general had opened up with his publications was desired even by the federal president. A letter from the Presidential Office on October 23, 1989, states that von Weizsäcker “will follow the discussion [on the Leuchter Report] closely.” Had the federal president lured General Remer into a trap with this letter? Remer naturally felt that ex-Minister of Justice Engelhard and the federal president had encouraged him to publish his facts.

Homicidal gas chambers that never came in contact with gas

All three expert reports came to the same conclusion: The gas chambers of Auschwitz and Birkenau testified to by witnesses never came in contact with Zyklon B. In legal terms: the weapon was not loaded. For better understanding: When hydrogen cyanide (Zyklon B) comes into contact with concrete or stones, it forms permanent compounds with traces of iron in such building material. The compound that develops is blue (hence the German name Blue Acid (*Blausäure*) for hydrogen cyanide, although the gas itself is colorless) and occurs on the surface and within the walls exposed to gas. Today, one can easily see a massive blue dyeing on both inner and outer walls in the delousing buildings. There is no such dyeing in the alleged homicidal gas chambers. Chemical analyses of samples from the delousing buildings show very high concentrations of cyanide, while no traces can be found in samples from the alleged gas chambers. Scientific expert reports were never produced for any of the numerous National Socialist trials. No physical proof was ever offered.

In Nuremberg, the propaganda lies of the victors were given reference numbers. Since then they have become “facts.”

All courts have continually prevented all gas chamber skeptics from use of any evidence for their scientific investigations. The courts have taken the point of view that the homicidal gas chambers should be re-

garded as commonly known “facts.” “Commonly known” means that the existence of homicidal gas chambers is as certain a fact as that the day has 24 hours. The Nuremberg Military Tribunal introduced the use of “common knowledge” into judicial practice. Pure war horror propaganda items from the Second World War were turned into “facts” (IMT-Statutes 19 and 21) which had to be accepted without question by the defendant. Defense attorneys who attempted to prove the opposite were threatened with the death penalty. The Stalinist massacre at Katyn was one of the charges, as well as homicidal gassings in the former concentration camp Dachau (IMT Document 2430-PS). In Document 3311-PS, the Polish government “put the victors’ tribunal on notice” that hundreds of thousands of Jews had been “steamed” at Treblinka. Note: “steamed,” not “gassed.” Today, the Holocausters look down shamefully when they are confronted with this nonsense. In the great National Socialist trial before the District and Chamber Court of Berlin (ref. PKs 3-50) it was determined: “There were no gas chamber structures in the concentration camp Majdanek.” But in Schweinfurt, General Remer was sentenced to imprisonment because he had published in his *Dispatches* the court’s determination on the absence of gas chambers in Majdanek.

To destroy the German people, only these words are necessary: “common knowledge.”

Concerning the alleged gas chambers, no one can speak of the kind of common knowledge such as that which underlies the fact that the day has 24 hours. Only such assertions, as that the day has 24 hours, require no proof. In all other cases there must be proof.

Remer’s proofs are new and far superior

The defense attorneys, Hajo Herrmann and Dr. Herbert Schaller, had prepared comprehensive evidence. They prepared their evidence to conform with a decision of the Upper District Court of Düsseldorf. In a “gas chamber denial” case, this court held that evidence must be admitted when it was superior to the “proofs” in the former National Socialist trials. New, superior evidence trumps “common knowledge,” according to the Düsseldorf court. The evidence submitted by the defense is new and far superior to that from the National Socialist trials, since there was no physical evidence presented there.

Herr Judge Siebenbürger, Herr State Attorney Baumann, please tell me which of the following figures is “common knowledge.” Why have you not told the General during the trial which number he should believe in? For which number should Remer now die in prison?	
Comparison of official figures on the number of those killed in the gas chambers of Auschwitz:	
Jul. 26, 1990: <i>Allgemeine Jüdische Wochenzeitung</i> 4,000,000	June 11, 1992: <i>Allgemeine Jüdische Wochenzeitung</i> 1,500,000
Apr. 20, 1978: French newspaper <i>Le Monde</i> 5,000,000	Sept. 1, 1989: French newspaper <i>Le Monde</i> 1,472,000
1945: International Military Tribunal in Nuremberg 4,000,000	1985: Raul Hilberg: <i>Die Vernichtung der europäischen Juden</i> 1,250,000
1979: The Pope during his visit to Auschwitz 4,000,000	July 1990: The left-wing TAZ and other newspapers 960,000
April 1990: Chief State Attorney Majorowsky/Wuppertal 4,000,000	1974: G. Reitlinger: <i>Die Endlösung</i> 850,000
1945: French War Crimes Investigations Office 8,000,000	1989: USSR releases death-books. Total deaths 66,000
1989: Eugen Kogon: <i>Der SS-Staat</i> 4,500,000	1965: Auschwitz decision 50/4 Ks 2/63. including claimed gassing deaths 45,510
1989: Lie-memorial tablet in Birkenau removed, with number 4,000,000	1965: Auschwitz decision 50/4 Ks 2/63, without claimed gassing deaths 619

Auschwitz: “Annihilation camp” with a brothel, legal advice, sauna and soccer ...

Before the examination of the evidence that had been submitted, attorney Herrmann addressed the state attorney and judge: “It must be proven, whether there were gas chambers or not, before there can be a decision on common knowledge. The court must determine facts.” Attorney Herrmann then presented evidence taken from anti-fascist literature and from court documents that showed that Auschwitz was no annihilation camp. The attorney read how there had been a brothel for prisoners in the Auschwitz camp, that there had been weekly soccer games between SS staff and camp inmates, that there was a central sauna, that legal advice was available to the inmates, that in case of non-natural death the camp administration had to notify the appropriate state attorney with over 30 signatures, that prisoners could be released, that

SS-men were not allowed to hit prisoners, that 4,800 sick persons were under medical care (although in the usual version, they landed in the “gas chambers” right away), and that, when the camp was abandoned, the prisoners preferred evacuation by the SS over Soviet “liberation”...

The State Attorney roars

This piece of evidence made the state attorney roar. “This piece of evidence is an insult to the victims,” he yelled into the courtroom with a red face. Herrmann replied, “Then your victims were insulted by the decision in the Auschwitz trial in Frankfurt, Herr State Attorney. Most of what I have just read are observations of the court in the great Auschwitz trial in Frankfurt. You can read them in the decision.” At this the state attorney was speechless. It is peculiar, how a state attorney can free himself from almost any evidentiary difficulty with only two magical words: “common knowledge.” He knew nothing about the decision in the National Socialist trials and he knew next to nothing about historical connections or physical facts. All a state attorney needs in such a case is to be able to pronounce the words, “denied on account of common knowledge.”

The court refused to accept this evidence. That is, it refused to accept whole passages from the decision in the Auschwitz trial in Frankfurt as well as passages from the writings of “survivors” such as Langbein. Naturally, on account of “common knowledge.”

The English crown: no gassings

As part of the evidence he submitted, Dr. Schaller presented the book of Jewish Princeton Professor Arno J. Mayer. In his book, Mayer concludes that the majority of Auschwitz prisoners died of natural causes and that there was no “Hitler order” for the “gassing” of the Jews. Mayer confirms that “proofs” for the gas chambers are “rare and unreliable.” As evidence against the “common knowledge of gas chambers,” the attorney submitted a book by British history professor F. H. Hinsley. Hinsley is the official historian of the English crown. His book *British Intelligence in the Second World War* can be obtained from the royal stationer’s office. There was a new edition in 1989. On page 673, Hinsley states that from 1942 the English were able to break the coded messages from the German concentration camps. The English found that the main cause of death in the camps was illness. Hinsley reports that there were also shootings and hangings. The official historical

scientist of the English royal house states: “There was no mention of gassings in the decoded messages.”

The state attorney moved that this evidence, too, be refused on account of “common knowledge.” One more time, the court agreed with the state attorney. At this point, the trial was suspended. It resumed on October 22, 1992. Every time General Remer reentered the courtroom after a pause in the proceedings, the public stood respectfully. Many remained sitting when the court entered, however.

An expert witness is kept out

The defense surprised the court with an evidence physically present in the courtroom, the technical expert Diplom-Chemist G. Rudolf. By the court’s rules of procedure, evidence that is physically present cannot be refused, even on account of “common knowledge.” The technical expert sat in the courtroom. He had researched the alleged gas chambers in Auschwitz from a physico-chemical point of view. He had taken samples of mortar and had them analyzed by the Institute Fresenius. Also he had conducted his own laboratory experiments in which he had gassed masonry with hydrogen cyanide. The expert witness could present scientific proof that the alleged gas chambers never came in contact with Zyklon B. The expert report prepared by the expert witness was submitted to the court with the rest of the evidence. The expert witness could also prove that prisoner commandos could not have “gone into blue clouds of Zyklon B still hovering over the corpses,” without having been killed themselves. This nonsensical testimony on work in the midst of clouds of Zyklon B had been given by Richard Böck, the principal witness in the Auschwitz trial in Frankfurt. Thus Böck was asserting that the commando had been immune to Zyklon B. Yet the judge in the Auschwitz trial in Frankfurt believed that he had proved the existence of gas chambers in Auschwitz with Böck’s statement. Böck had witnessed the gassings in two farm-houses which never existed, according to a technical report of HANSA LUFTBILD, which analyzed Allied air-reconnaissance photos. The expert witness could also prove that hydrogen cyanide is a colorless poison. The expert witness was sitting in the courtroom. He could provide clarification. What did the state attorney have to say about that?

“I move that the expert witness be refused, since the gas chambers are common knowledge fact,” was state attorney’s monotonous refrain. He demanded that the expert witness be refused without his technical qualifications having been examined. The court agreed with the motion

of the state attorney and refused the expert witness, without having heard a word he had to say, as “completely unsuitable evidence.” In addition, the court refused to read the expert report, because of “common knowledge.”

No one can see the Auschwitz death-books

Attorney Herrmann next submitted a large selection from the official death books of Auschwitz. In 1989, these death books had been released by the Soviet Union. These official papers documented 66,000 cases of death in minute detail. All of them are under seal at the special effects office in Arolsen. No one is allowed to look at them. A ten country commission, including Israel, prevents any inspection of these documents. Recently, the journalist W. Kempkens succeeded in photocopying these documents in the Moscow archive.



*Defense Attorney ret. Colonel
Hajo Herrmann*

Herrmann submitted a representative sample to the court. The defense attorney moved that Kempkens be allowed to testify. The Holocausters keep talking about how the old and unfit-for-work Jews were sorted out on the “ramp” and “gassed” immediately, so they could not have been entered in the camp register. The death books prove the opposite. Most of the entries were elderly men and most were Jews. The state attorney moved that the documents should not be admitted as evidence, since the gas chambers are “common knowledge” fact. The court agreed with the motion of the state attorney.

The State Attorney’s pleading

At that point, the taking of evidence was ended and the state attorney began his pleading. He did not need any evidence, since for him the “gas chambers” are “common knowledge.” He described Remer as Mephisto (the devil) for “denying” what is “common knowledge.” For such a “devil,” he argued, the absolute minimum sentence should be imprisonment for two years and six months. He moved that the imprisonment begin immediately.

Defense Attorney Herrmann's pleading

The attorney protested, "We have submitted evidence in many areas, but the court has never undertaken to examine whether the defendant had a valid claim." Once more Herrmann discussed the denial of evidence in connection with the "confession" of the former camp commander of Auschwitz, Rudolf Höß. "The court had refused to allow the reading of Höß's torture with the comment that it had not been proven that Höß had made a false confession because of torture. But Höß's confession is false," thundered the retired colonel, a former inspector of Germany's WWII night fighters, in the courtroom. "Höß confessed 3 million murdered Jews. Today Holocaust historians say the number killed is 1.5 million," he flung at the state attorney and judge. Then Herrmann read the record of the capture of Höß. It is described there how the former commandant was thrown on a butcher bench and how his face was smashed for hours. The Jewish sergeant shoved a guideline staff deep in his throat and dumped a whole bottle of whiskey into his victim. His handcuffs were left on for three weeks. "That's what you don't want to hear, Herr State Attorney," the defense attorney's words rang out. Then Herrmann read relevant paragraphs from the transfer treaty of the occupying powers. In these paragraphs, Germany was forced to recognize forever the historical "facts" that were the basis of the Nuremberg trials. And so German courts still say "common knowledge" to the four million Auschwitz lie, to the lie about gassings in Dachau and the lie about "mass steamings" in Treblinka. Nonsense and oppression know no limit.

"I note," said the attorney, "that the defendant was denied his right. Not only the state attorney is bound politically. This is about an obligation imposed on the state by the transfer treaty of the victorious powers. But this treaty has no place in this court of law."

Then he continued, "I have never before seen the public stand when an defendant enters the courtroom. Yes, the general is no turncoat, and that is basically what you are accusing him of." Herrmann pinpointed the state attorney's error: "The state attorney refuses to accept as evidence the decision of the Auschwitz trial in Frankfurt, which counted 45,510 dead." Herrmann hammered on the conscience of the state attorney, which unfortunately does not exist. Then he continued, "But, according to the state attorney, the defendant must know that 6 million Jews were gassed." Herrmann turned to the judge's bench and shouted: "The court intends to prove that the defendant acted with criminal intent, that 'he knows it.'"

The public realized that this great man had lived through times where just dealing, dignity, honor, and decency were still common. A trial like the present was very difficult for him. Once again, Herrmann counted the denied pieces of evidence and asked, “Who in this courtroom was not well served by the defense?” Then he confronted the state attorney and said, “The state attorney will try to convince the defendant that he knew that what he said was not true. Herr State Attorney, you do not sit in the back of the defendant’s head.”

Then the attorney said what he thought was behind the court’s – in

Judge Siebenbürger and state attorney Baumann justified themselves with this kind of witness when they yell, “Evidence denied on account of common knowledge.”

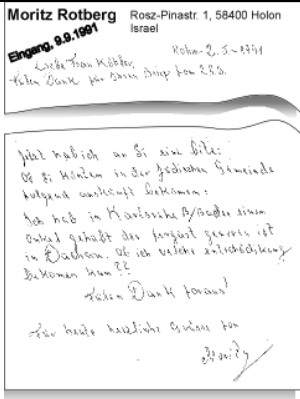

*Holon, Israel 2.5-1991
 I once had an uncle in Karllsruhe B/Baden
 that was gast in Dachau. I can get some
 damajes frm this?? Much thank in advans!
 [misspellings in original]*

This text is taken from a letter that was mailed on May 2, 1991, from Holon/Israel to a German acquaintance with the request for help with an application for compensation. The writer’s uncle was “gast” in Dachau and he wanted “damajes.” For Judge Siebenbürger and state attorney Baumann, this served to prove that the gas chambers are “common knowledge.”

Response of the City of Dachau:

**City of
 DACHAU**

**District capital
 (coat of arms)**

Our Ref.: 4.2/Ra/Sa

Artists’ town for 1200 years

Date: 14.11.88

Dear Herr Geller!

With reference to your question, I must inform you that there were no gassings in the former concentration camp Dachau ...

Best regards - Rahm; Director of Administration

many people's opinion – scandalous handling of the trial: “I believe that there is another power that hangs over our legal system that gives you your orders. I know that if you were to acquit, there would be a great howling – not just here, but mostly in other countries. If you fear this, you should decline to conduct the trial. How can you designate even one piece of evidence as superfluous when the issue is life or death, as it is here? You should recollect that the chief prosecutor at Nuremberg described the victorious powers' tribunal as a continuation of the war against Germany. One cannot so totally de-



Defense Attorney Dr. Herbert
Schaller

stroy and plunder a civilized people such as the Germans without an ostensible reason or pretext. Auschwitz was that pretext.

If ‘common knowledge’ does not endure forever, at what limit of common knowledge do we find ourselves now? Yes, this ‘common knowledge’ will collapse, but will the defendant die in his prison cell beforehand?” With that, Attorney Herrmann ended his pleading.

Dr. Schaller's pleading

“This is a political trial of a very peculiar nature,” the courageous Viennese attorney threw at the judge and state attorney. “For the reason that it deals with a crime of opinion, where there was no violence. The defenders of democracy sit on the accuser's bench. When a democratic state takes upon itself the power to determine what the truth is, it is no longer a democracy,” the attorney admonished the state attorney and court.

Dr. Schaller told of a case in Frankfurt of an African drug dealer with a criminal history who stuck a 17 centimeter long knife into the abdomen of a young German because the latter did not want to buy drugs. The attorney quoted the *Frankfurter Allgemeine Zeitung* newspaper, as to how the judge in this case would not regard the assault as attempted murder or even as attempted manslaughter. She regarded it as a case of the African merely wanting to “teach the German a lesson.” This example of justice in modern-day Germany that Dr. Schaller so

graphically portrayed is reminiscent of the case of two Turks who stabbed an 18-year old German in Berlin because the latter had blond hair. Both Turks had already been convicted of manslaughter, yet they received probation. For the 80-year-old General Remer who published scientific papers, the state attorney wants the “death sentence.” In the waiting room, people passed around articles from large German newspapers relating how foreign murderers, robbers and mankillers are set free because indictments cannot be prepared in time due to “shortage of staff.” Every spectator was outraged that there was no shortage of judges to handle the prosecution and indictment of an acknowledged national hero because of his publication of the truth. Dr. Schaller said further:

“To prosecute assertions of fact in the same way that murderers should be prosecuted – but today no longer are – will lead to social collapse.

The state should take care that arguments are expressed in words. The truth does not need criminal justice. The truth will prevail of its own power,”

the attorney scolded the state attorney. The attorney further said:

“Doesn’t the state attorney’s demand for a two and a half year sentence for the publication of scientific knowledge smell of [communist east German] GDR justice? And such a thing for an 80-year-old man? Is this Bautzen?”^[610] demanded Dr. Schaller.

“This defense team has introduced a plethora of evidence that supports the claims of the defendant. A plethora of proofs and expert reports that has never been presented to any court of the victorious wartime Allies. And yet, the Allies’ magic words from Nuremberg, ‘common knowledge’ should still apply here?”

Facing the state attorney, Schaller asked:

“Suppose that we had a new government in Germany and this government were to examine the manner in which you servants of the state are proceeding, keeping in mind paragraphs 56 and 62 through 65 of the Basic Law. Do you think you would escape harm from the hands of the German people?”

Then, facing the public:

“Suppose the state attorney had to justify his charges against the General. Suppose a judge should ask him, what proof do you have of the existence of homicidal gas chambers? He would have nothing to show. But as of today, no state attorney needs to produce evidence. We have not arrived at that point yet.”

Next he quoted the Jewish revisionist, Rabbi Immanuel Jakobovits, who says:

⁶¹⁰ An infamous prison for political prisoners in former communist East Germany.

“Today, there is a whole spectrum of business relating to the Holocaust Industry, with authors, researchers, museum curators and politicians.”

To the judges’ bench, Dr. Schaller hollered:

“The real threat to public order begins when one demands of the German people that they should assume guilt for gas chamber murders.

These are dangerous perversions which construe publication of scientific investigation of alleged gas chambers as defamation and incitement to racial hatred. How does the state attorney dispute this scientific evidence which the defendant has published? He merely tells us that we Germans should and must remain guilty as charged at the Nuremberg trials following World War II. That is all.

On the other hand, the defense counsels have an expert witness here in the courtroom who has produced an expert report that leaves no question unanswered. The expert witness has come to the indisputable scientific conclusion that the so-called gas chambers never came in contact with Zyklon B gas. Never!”

Schaller continued:

“There sits the technical expert, who is not allowed to say a word. A scientist from the world renowned Max-Planck-Institute is not allowed to testify in a German court! And you want to send General Remer to prison? Are you willing to accept responsibility for that?”

Then, raising his voice:

“The defendant has the right to expect that the court will fulfill its duty. that is, to inquire into the innocence of the defendant. This kowtowing to the victorious Allies of World War II cannot go on forever!”

With the following words tears came to his eyes:

“Why should a man be put to the sword to keep alive this mythology of wartime propaganda? Mr. state attorney, you should not continue believing novels that become ever more lurid with the passage of time. It cannot go on like this, to leave one’s own people standing out in the cold. Please allow the introduction of evidence once more.”

Thus the defense attorney closed his pleading.

The General’s closing words

“To this kangaroo court that has denied me the introduction of scientific evidence I have only one thing to say.”

General Remer pointed at the state attorney and the judge:

“Germany will one day hold you responsible for what you have done in this courtroom.”

Résumé

General Remer seems to be dangerous to the former victorious powers because he has brought about a discussion of Auschwitz with his scientific publications. If Remer can prove his case, the Allies will lose their justification for having butchered and looted the German people. The Jews will lose, as Prof. Wolffsohn says, “their only remaining identity-forming myth.” For these reasons, General Remer is condemned to die in jail. This death sentence is reminiscent of other cases of unsolved deaths such as those of Franz Josef Strauß and his wife Marianne. First Marianne died of unexplained causes in a traffic accident, then the fit, healthy former minister president of Bavaria passed away under unusual circumstances which are not medically explicable.

The *Allgemeine Jüdische Wochenzeitung* (German Jewish weekly newspaper) of October 29, 1992, recalled Strauß’ goals: “The declaration of Franz J. Strauß on February 1, 1987, that the federal republic should come out from under the shadow of the Nazi past and begin a new chapter in the book of history...”

The transfer treaty of the victorious powers forbids Germany to “come out from under the shadow of the Nazi past and begin a new chapter in the book of history.” The Allies would lose forever their justification for the horrendous crimes and ethnic cleansing which they committed against Germany, and the Jews would lose their identity-forming principle. This might endanger the existence of the state of Israel. Are there parallels between Remer’s “death sentence” and the death of Marianne and F. J. Strauß?

5.2. The Second Crime: A Scientific Anthology

Beginning on 7th of May 1995, Judge Burkhardt Stein of the County Court of Tübingen, southwest Germany, held court on the fates of the publisher, editor, and some of the authors of the fundamental revisionist work *Grundlagen zur Zeitgeschichte* (ref. 4 Gs 173/95).⁵⁹⁹ First, the proceedings against the authors were separated on various grounds. Next, the trial against the editor Ernst Gauss alias Germar Rudolf was separated, because the defendant was not present at the proceedings. For that reason, Judge Stein issued an arrest warrant against Rudolf.

During the trial, the public attorney and the judge accused the publisher Wigbert Grabert that the incriminated book would meet the test

for the crime of inciting to racial hatred, in that it used a number of Holocaust denying adjectives such as “alleged,” “claimed,” “supposed,” “presumed” and “so-called.” In order to show that the book had scientific merits, the defense attorney insisted that, while reading certain passages from the book, one needed to consult the comprehensive and detailed footnotes that it contained, which made reference mostly to books of establishment sources. The judge merely turned toward Susanne Teschner, the public attorney, and answered that the court would not think out loud during the trial. The court denied numerous motions of the defense for recourse to relevant expert reports or for access to court records that might show that the words “supposed,” and so forth, did not *per se* constitute an intentional denying.

The court also denied two motions of the defense to suspend the trial on grounds that in this trial there was theoretically no possibility that the judge would acquit the defendant, because in such a case the judge himself might encounter social harassment or even criminal reprisal from the judicial system, as the case of Judge Orlet in the trial against the revisionist Günter Deckert had shown.

Several days after the beginning of the trial, the expert witness Dr. Joachim Hoffmann was interrogated as to whether the book *Grundlagen zur Zeitgeschichte* was scientific. Dr. Hoffmann, for decades a historian in the *Militärgeschichtliche Forschungsamt* (Research Department for Military History) of the German Armed Forces (*Bundeswehr*) in Freiburg, wrote an expert report on request of the defendant Gernar Rudolf, in which he confirmed that the book at issue was scientific in nature and should therefore be protected by Germany’s Basic Law. The text of his expert report has been published in English elsewhere.⁶¹¹

During his interrogation, the expert witness stated that terms such as “presumed” or “supposed” did not please him, yet he did not consider that they put the scientific merit of the book in question.

The public attorney’s pleading was next. The phrases in the book that offended her most – “supposed annihilation camp,” “Auschwitz bludgeon,” “Holocaust religion,” “identity-forming group fantasies,” “supposed genocide,” “established Holocaust scene,” “lead ad absurdum” – although taken partly from established publications, deny the National Socialist murder of Jews and therefore qualify as incitement to racial hatred. According to the public attorney, the expert witness Dr. Hoffmann was no more competent to judge whether the book was scientific than a judge or a state attorney is, and his expert report should

⁶¹¹ G. Rudolf (ed.), *op. cit.* (note 24), pp. 563-566.

therefore be disregarded. The publisher Grabert should be sentenced to 9 months imprisonment on probation.

On the last day of the trial, held on a Saturday(!),⁶¹² June 15, 1996, in his pleading the defense attorney referred to the denunciations of the public attorney, whereby the book was allegedly a pseudo-scientific hack-job of the vilest sort, saying that this sort of speech was “pseudo-legal browbeating” without content or definition. The defense pointed to the high degree of scientific expertise that had been necessary to produce the book and also to the fact that the expert witness had unreservedly confirmed the book’s scientific quality. He also pointed out that section 130, paragraph 3, of the German Penal Code (incitement to racial hatred) was unconstitutional when it served to deliver proven scientific publications up to book-burning.

The judge sentenced the publisher Grabert to pay a fine of DM 30,000 (\$15,000) and ordered the seizure – in effect, the burning – of all copies of *Grundlagen zur Zeitgeschichte* as well as all materials needed to produce it. In the written verdict he stated that, although parts of the book had scientific merit, phrases such as “supposed,” “presumed,” “burnt sacrifice of the Jews,” “imputed systematic nature,” “furious fantasies,” although partly drawn from citations of established personages, denied the Holocaust and therefore qualified as the crime of incitement to racial hatred.

5.3. More Thought Crimes...

Since I fled my home country in early 1996, many more criminal prosecutions were started for publications I authored, edited, published, or distributed, and keep authoring, editing, publishing, and distributing. The following list contains cases where such proceedings came to my knowledge. Since distributing literature banned by the German Federal Review Office for Youth-Endangering Publications (*Bundesprüfstelle für jugendgefährdende Schriften*) is a criminal offense in Germany, and each confiscation of literature by a German court is accompanied automatically by criminal prosecution against those who authored, edited, published, distributed, printed, imported, exported, stored or otherwise made available the confiscated literature, each of the following cases is considered to be a crime under the tough German thought crime legislation. One must therefore assume that each of the following cases may

⁶¹² In Germany, courts of law do not hold sessions on Saturdays – with this exception.

result in at least one criminal proceeding against me. Finally, I have added a list of works published by me for which it is unknown if any criminal proceedings were started. Since the content of these publications is comparable to the other publications listed here, it must be expected that in any of these cases criminal investigations have been or will be started.

1. In 1994, the State Prosecution Office of Böblingen confiscated the following books written by Gernar Rudolf. It is likely that Rudolf's ongoing distribution of these publications since 1994 – both in printed form as well as online – led to further criminal proceedings against him (County Court Böblingen, 9 Gs 521/94):
 - Rüdiger Kammerer, Armin Solms (ed.), *Wissenschaftlicher Erd-rutsch durch das Rudolf Gutachten*, Cromwell Press, London 1993.⁶¹³
 - Manfred Köhler, *Prof. Dr. Ernst Nolte: Auch Holocaust-Lügen haben kurze Beine*, Cromwell Press, London 1994.⁶¹⁴
 - Wilhelm Schlesiger, *Der Fall Rudolf*, Cromwell Press, Brighton 1994.⁶¹⁵
2. In 1996, the County Court Munich ordered the confiscation and destruction of the issue 6/1995 of the periodical *Staatsbriefe* (Castel del Monte, Munich), because of an article authored by Gernar Rudolf (County Court Munich, 8440 Ds 112 Js 10161/96)⁶¹⁶
3. In 1996, the County Court Berlin Tiergarten ordered the confiscation and destruction of the issues 2 and 3/1995 of the periodical *Sleipnir* (Castel del Monte, Munich), because of an article authored by Gernar Rudolf (County Court Berlin-Tiergarten, 271 Ds 155/96)⁶¹⁷
4. During a search of his property in March 1997, the Judge Dr. Payer of County Court Böblingen orders the search of a German PO Box

⁶¹³ An (outdated) translation of it was published without my knowledge: Rüdiger Kammerer, Armin Solms (eds.), *A Scientific Sensation—The Rudolf Report*, Historical Review Press, Uckfield 2002.

⁶¹⁴ Online: www.vho.org/D/Nolte; updated in G. Rudolf, C. Mattogno, *op. cit.* (note 58), pp. 127-183; no Engl. version available.

⁶¹⁵ Engl.: www.vho.org/GB/Books/trc

⁶¹⁶ “Naht ein deutscher Bürgerkrieg?,” *Staatsbriefe* 6(6) (1995), pp. 6-8, online German only: www.vho.org/D/Staatsbriefe/Rudolf6_6.html.

⁶¹⁷ G. Rudolf and J. Markiewicz, W. Gubala, J. Labedz, “Briefwechsel,” *Sleipnir*, 1(3) (1995) pp. 29-33; Engl.: *op. cit.* (note 64); G. Rudolf, “Kein Brief ins Gefängnis?,” *Sleipnir* 1(2) (1995), not online. The criminal investigation against me in that case, Public Attorney's Office I in the Berlin District Court, ref. 81 Js 1385/95, was dropped on March 21, 1996, under sec. 154 German Penal Procedure Rules (StPO), because the expected punishment “would not carry much weight” in comparison to the one expected from the District Court of Stuttgart in my first “thought crime” trial.

- used by Germar Rudolf, and its formal owner, because of a prosecution launched against Rudolf for disseminating revisionist literature via the Internet address www.codoh.com, where this PO Box is given as a contact address (County Court Böblingen, ref. 9(8) Gs 228/97).
5. In 1997, the County Court Weinheim ordered the confiscation and destruction of the book formally edited by Herbert Verbeke, but factually written and published by Germar Rudolf, *Kardinalfragen zur Zeitgeschichte* (“Cardinal Questions of Contemporary History”), Vrij Historisch Onderzoek, Berchem 1996 (County Court Weinheim, ref. 2 Ds 11 Js 5428/97).⁶¹⁸
 6. In 1997, the County Court Böblingen ordered the confiscation and destruction of the book edited by Rüdiger Kammerer, Armin Solms, and authored by Germar Rudolf, *Das Rudolf Gutachten*, Cromwell Press, London 1993 (County Court Böblingen, ref. 9(8) Gs 228/97).
 7. In 1997, the County Court Böblingen ordered the confiscation and destruction of the book formally edited by Herbert Verbeke, but factually edited and co-authored by Germar Rudolf under the pen names Ernst Gauss and Manfred Köhler, *Auschwitz: Nackte Fakten*, Vrij Historisch Onderzoek, Berchem 1996 (County Court Böblingen, ref. 9(8) Gs 228/97).⁶¹⁹ On April 8, 1999, the German Federal Review Office for Youth-Endangering Publications put this book on its list of prohibited literature (*Bundesanzeiger* No. 81, April 30, 1999)
 8. On December 2, 1997, the German Federal Review Office for Youth-Endangering Publications informs the publisher of the journal *Vierteljahreshefte für freie Geschichtsforschung* (“Quarterly for Free Historical Research”),⁶²⁰ formally Herbert Verbeke, but factually Germar Rudolf, that it is going to put issues one and two of the year 1997 on its list of prohibited literature.
 9. On May 12, 1998, the German Federal Review Office for Youth-Endangering Publications informs the formally responsible person of the website www.vho.org, Herbert Verbeke, but factually and since summer 1998 even formally Germar Rudolf, that it is going to put the entire content of this website on its list of prohibited literature (Ref. No. BPjS, Pr. 273/98 UK/Schm).⁶²¹

⁶¹⁸ Engl.: www.vho.org/GB/Books/cq

⁶¹⁹ Engl.: www.vho.org/dl/ENG/apf.pdf.

⁶²⁰ Engl. equivalent: www.vho.org/tr.

⁶²¹ See the transcript of this document at www.vho.org/censor/BPjS_vho.html (German).

10. On August 25, 1998, the Office of State Prosecution in Munich I informs the publisher of the journal *Vierteljahreshefte für freie Geschichtsforschung*, formally Herbert Verbeke, but factually Germar Rudolf, that criminal proceedings have been started against them for an article published in the issue 1/1998 of this journal, dealing with the ground water table in the region of the former concentration camp Auschwitz-Birkenau (Staatsanwaltschaft Munich I, ref. 112 Js 11282/98).
11. On January 12, 1999, the German Federal Review Office for Youth-Endangering Publications informs the publisher of the journal *Vierteljahreshefte für freie Geschichtsforschung*, formally Herbert Verbeke, but factually Germar Rudolf, that it put issues three and four of the year 1997 on its list of prohibited literature (Ref. No. 5490 (V)).
12. On March 30, 1999, the County Court Munich ordered the confiscation and destruction of the issue 2/1998 of the journal *Vierteljahreshefte für freie Geschichtsforschung* (Quarterly for Free Historical Research), published by Germar Rudolf, and informs him that criminal proceedings were initiated against him. Reasons for this were mainly two articles dealing with the concentration camp Majdanek⁶²² and with microwave delousing facilities in the concentration camp Auschwitz⁶²³ (County Court Munich, ref. 812 Gs 16/98).
13. On January 5, 2000, the German Federal Review Office for Youth-Endangering Publications informs the publisher of the book *KL Majdanek. Eine historische und technische Studie (Concentration Camp Majdanek: A Historical and Technical Study)*, Germar Rudolf, that it put this book on its list of prohibited literature (Ref. 5715(V), *Bundesanzeiger* No. 20, Jan. 29, 2000).⁶²⁴
14. On April 19, 2000, the police of Baden-Württemberg confiscated and destroyed all copies available of the book *Vorlesungen über Zeitgeschichte* (Lectures on Contemporary History), authored by Germar Rudolf under the pen name Ernst Gauss, as ordered by the County Court Tübingen (County Court Tübingen, ref. 4 Gs 312/2000).⁶²⁵

⁶²² A review of the later confiscated book on the same topic, see next entry.

⁶²³ Hans Jürgen Nowak, "Kurzwellen-Entlausungsanlagen in Auschwitz," *Vierteljahreshefte für freie Geschichtsforschung* 2(2) (1998), pp. 87-105; Engl.: in G. Rudolf (ed.), *op. cit.* (note 24), pp. 312-324.

⁶²⁴ Engl.: www.vho.org/dl/ENG/ccm.pdf.

⁶²⁵ Engl.: www.vho.org/dl/ENG/loth.pdf.

15. Criminal investigation so far unknown, but most likely: J. Graf, C. Mattogno, *Das Konzentrationslager Stutthof und seine Funktion in der nationalsozialistischen Judenpolitik*, Castle Hill Publishers, Hastings 1999.⁶²⁶
16. Criminal investigation so far unknown, but most likely: J. Graf, *Riese auf tönernen Füßen. Raul Hilberg und sein Standardwerk über den "Holocaust,"* Castle Hill Publishers, Hastings 1999.⁶²⁷
17. Criminal investigation so far unknown, but most likely: *Vierteljahreshefte für freie Geschichtsforschung*, all issues since 3/1998 (four each year).
18. Criminal investigation so far unknown, but most likely: Ernst Gauss (ed.) (i.e., Gernar Rudolf), *Dissecting the Holocaust: The Growing Critique of "Truth" and "Memory,"* Theses & Dissertations Press, Capshaw 2000.⁶²³
19. In August 2002, a customer of mine made me aware of the fact that criminal proceedings were started against him because he had ordered ten copies of the German version of this book, *Das Rudolf Gutachten*, Castle Hill Publishers, Hastings 2001.⁶²⁸ This means that distributing this book in Germany is considered a crime, so a criminal investigation must have been started against me because of this book.
20. Criminal investigation so far unknown, but most likely: C. Mattogno, J. Graf, *Treblinka. Durchgangslager oder Vernichtungslager? (Treblinka: Transit Camp or Extermination Camp?)*, Castle Hill Publishers, Hastings 2002.⁶²⁹

Each of these crimes,⁶³⁰ which are doubtlessly covered by the First Amendment of the U.S. Constitution, can be punished with up to five years in prison in Germany. Would I surrender to the German authorities, I might well face some 10 years in prison for my scientific writings and for my internet fight against German censorship, to which I have devoted parts of my website www.vho.org. This site offers all the litera-

⁶²⁶ Engl.: www.vho.org/dl/ENG/ccs.pdf.

⁶²⁷ Engl.: www.vho.org/dl/ENG/Giant.pdf.

⁶²⁸ Engl: the present book.

⁶²⁹ Engl.: www.vho.org/dl/ENG/t.pdf.

⁶³⁰ By the time of my arrest in late 2005 this list had grown to some 60 positions. The 2004 arrest warrant listed some 30 of them, whereas the 2006 indictment included "only" nine (see www.germarrudolf.com/persecute/docs/Rudolf_Anklageschrift.pdf). The 2007 verdict of the Mannheim District Court eventually concerned only two of these items (see www.germarrudolf.com/persecute/docs/MannheimVerdict2007_E.pdf).

ture banned and confiscated by German authorities, as long as it does not promote pornography or violence.⁶³¹

⁶³¹ See online: www.who.org/censor.

6. The Media and the Case of Germar Rudolf

The Object of Zeal⁶³²

When in spring 1992 Germar Rudolf sent out the first draft of his “Expert Report on the Formation and Detectability of Cyanide Compounds in the ‘Gas Chambers’ of Auschwitz” to a narrow circle of recipients in science and politics, several historians responded with interest. The media, however, received no notice of the existence of the report. Only in spring 1993, when retired Major General Otto Ernst Remer took a later draft of the expert report, provided it with a peppery political preface, and then sent some 1,000 to 2,000 copies to the media, public attorneys, politicians, and scientists, did a certain circle of the Establishment learn of the existence of this report.

The press was quiet, except for two short articles that appeared on May 8/9 and 13, 1993, in the *Wiesbadener Kurier* reporting on the embarrassment the expert report had caused to the chemical analysis Institute Fresenius hired by Rudolf, located in Taunusstein near Wiesbaden, and an announcement in the *Märkische Allgemeine Zeitung* of May 14, 1993, that a certain Prof. L. Bisky had filed a criminal complaint. Finally, in spring 1994, when the Labor Court heard the case between Rudolf and his former employer, the Max-Planck-Institute for Solid State Research at Stuttgart, which ended with a compromise, the DPA (German Press Agency) issued a press release that appeared in many newspapers and even on the radio. That prompted the ARD (German Public Broadcasting) television program *Report* to make a witch-hunt broadcast.

In the regional press of the Stuttgart area, where Rudolf resided at that time, there appeared mostly factual police notices, reporting that the State Security Department of the Criminal Police of Baden-Württemberg⁶³³ for various reasons had ordered house-searches (Sep-

⁶³² First published in German in *Staatsbriefe* 2-3/1996, pp. 23-30.

⁶³³ The uninitiated reader may be unaware that in Germany there is a division of the Criminal Police called the State Security Department which prosecutes politically motivated crimes. This department, by far the largest of the criminal offices, has separate areas for right-wing extremist, left-wing extremist, and foreign-influenced political crimes, respectively. Those employed in one department tend to have a political opinion hostile to their target group. For example, those in the right-wing extremist department tend to have left-wing, anti-fascist orientations. In addition, the German Federal court system includes State Security Chambers whose only work is to punish politically motivated crimes. The prosecutors who work in these courts were politically trained to deal with such crimes.

tember 30, 1993,⁶³⁴ August 18, 1994,⁶³⁵ and March 27, 1995⁶³⁶). However, the headlines were occasionally ridiculous. For example, the headline “Nazi book depot in Steinenbronn” appeared in the *Böblinger Bote* of March 29, 1995. In fact, there were neither Nazis, Nazi material nor a book depot in Rudolf’s home.

The authorized version of the expert report was published in summer 1993 in Great Britain with the title *Das Rudolf Gutachten* and has been distributed and sold in Germany since then.⁶³⁷ There has been no echo about this version in the media.

The media showed increased interest when the 17th State Security Chamber of the Stuttgart District Court began the criminal investigation against me on account of suspicion of participation in the preparation and distribution of Remer’s commented version of my report. However, they were not interested in the Expert Report nor in me, but merely in the question, whether there should be made an example “to punish the right-wing” for reasons of public instruction.

The trial proceedings did not center upon the actual contents of my expert report, but on Remer’s political commentary and my (alleged) political views. This was despite the fact that prosecutions for dissenting political views are forbidden according to the German constitution (cf. article 3.3. of the German Basic law). They have a strong tendency to turn into show-trials, and this is exactly what happened in this case.

Later on, several of the media reports that were published in the course of the hubbub over the Rudolf expert report and its author attempted to critically evaluate how true – or rather how false – this expert report was.

The Expert Opinion of the DPA – Invented from Whole Cloth

On March 28, 1994, the Max-Planck-Gesellschaft (MPG, M. P. Society), an umbrella organization of some 200 Max Planck Institutes all over Germany and Austria – I had been a PhD student at one of them – issued a press release on my expert report. They reported on internal

⁶³⁴ This house search concerned the commented version of my expert report distributed by Remer.

⁶³⁵ This house search was due to suspicion of participation in the production and distribution of the newsletters *Remer Depesche* and *Deutschland Report* (later renamed to *National Journal*, see www.globalfire.tv/nj/).

⁶³⁶ This house search concerned the revisionist anthology edited by me under the pseudonym Ernst Gauss entitled *Grundlagen zur Zeitgeschichte*, Grabert, Tübingen 1994; Engl.: G. Rudolf (ed.), *Dissecting the Holocaust*, *op. cit.* (note 24).

⁶³⁷ R. Kammerer, A. Solms (ed.), *Das Rudolf Gutachten*, Cromwell, London 1993.

measures taken by my former employer, the Max Planck Institute for Solid State Research in Stuttgart, against me. The MPG made it clear that since they agreed with the German Federal Constitutional Court and the Federal Supreme Court as to the commonly known fact of the Holocaust, they would not involve themselves in the discussion of the issues raised by my expert report.

The news release of the DPA Press Bureau Stuttgart which appeared the following day in almost all German newspapers and also on the radio contained the following passage:⁶³⁸

“According to their spokesman, the Max Planck Society has no proof that the samples are really from Auschwitz. Even if they are from there, according to expert opinion, it is certainly no wonder that no traces of hydrogen cyanide were found, because cyanide compounds disintegrate quickly. In earth this takes six to eight weeks and in stone they can only be preserved by “absolute conservation conditions, including complete exclusion of air and bacteria.”

Of course, the Max Planck Society had no evidence about the origin of the samples, since they did not ask me for any and I had no reason to give them any without having been asked. This is nothing else but a clumsy diversion from the main question. And by the way: if this topic is important to anybody, no one is prevented from verifying the results of my expert report and the test results of others as discussed in chapter 8.

On inquiry about the supposed expert opinion about the instability of cyanide compounds, Albert Meinecke, the person at DPA apparently responsible for the notice, referred first to the press statement from the MPG.⁶³⁹ After it was shown to Meinecke that the statement contained no comment on the factual content of the expert report, nor any comment on the stability or presence of cyanide compounds,⁶³⁸ he made various claims, depending on the caller and the time of the call:

- a) He did not have the source for the expert opinion at hand.^{639,640}
- b) He did not know who was responsible for the press notice.⁶³⁹
- c) The person responsible for the notice was out of the office.⁶³⁹
- d) The person responsible for the notice was possibly on vacation.⁶³⁹
- e) Since Meinecke had said both b) and c) in the same conversation, he was confronted with the fact that he had contradicted himself and that he must know very well who the responsible party was if

⁶³⁸ Daily newspapers, such as *Süddeutsche Zeitung*, *Stuttgarter Zeitung*, *Südwestpresse-Verbund* (March 29, 1994), *taz*, *Frankfurter Rundschau* (March 30, 1994).

⁶³⁹ Telephone conversation of K. Philipp, Frankfurt/Main, March 30, 1994.

⁶⁴⁰ Telephone conversation of G. Rudolf, Jettingen, March 30, 1994.

he could say the person was not in the office. When asked if he had not made a great pile of goat-dung with his press notice, he opined that no one was without fault.⁶³⁹

f) He would call Rudolf when he knew more about who was responsible and what the source was.⁶³⁹ As of January 2003, this has still not happened.

The connection between the MPG and the unnamed expert opinion created by the phraseology of the DPA notice would suggest to the reader that the expert opinion was that of the MPG. The latter declared by fax on April 12, 1994, that this was not the case and that the claim in the DPA notice was mistaken.

After two weeks of silence, on April 13, 1994, DPA Editor-in-Chief D. Ebeling of Hamburg, speaking for the agency, announced in a fax message to me that the unnamed expert would remain unnamed to protect his privacy. Two days later, in an unsigned faxed notice, A. Meinecke denied my accusation of falsehood⁶⁴¹ and referred me to the Editor-in-Chief in Hamburg.

The Technical Issues

Among others, the DPA notice contained the following assertion:

“Even if they [the samples] are from there [Auschwitz], according to expert opinion, it is certainly no wonder that no traces of hydrogen cyanide were found, because cyanide compounds disintegrate quickly.”

Evidently the writer of these lines does not know the difference between hydrogen cyanide and cyanide compounds. If he should wish to subsume cyanide compounds under hydrogen cyanide, which might make it easier for the layman to understand, then it is clear: This sentence and the following one discuss the stability of cyanide compounds, the only thing that makes sense with respect to the Rudolf Report. The question as to the stability of hydrogen cyanide itself, as raised by Ebeling in his fax to me, is of no concern to anyone⁶⁴² – the question is a useless diversion from the subject.

The supposed statements of the unknown expert assert that cyanide compounds disintegrate quickly. This blanket claim is and will always be untenable and shameful for any expert to make. As proof for this, the reader may simply go back to chapter 6.6. of this book, and there in particular to chapter 6.6.5. (page 166).

⁶⁴¹ Press release, G. Rudolf on April 8, 1994.

⁶⁴² D. Ebeling’s response to numerous queries to the Stuttgarter DPA bureau, April 13, 1994.

Ebeling's assertions that stable compounds may form but do not necessarily form⁶⁴¹ needs no confirmation from competent authority, since the fact that every acid in the world forms stable as well as unstable compounds is as trivial as an "Amen" in church.

In the DPA notice it was stated that cyanide compounds will last in stone only under "absolute conservation conditions," but in contrast to that, in the masonry of the cases of interest here and investigated in detail in this report, the disinfection chambers of Auschwitz, hydrogen cyanide formed extremely long-lasting iron cyanide compounds of the Iron Blue type. See the arguments given above for proof of this.

Therefore, not only is the claim of the DPA press release wrong that this statement stemmed from an expert, but the actual content of this release is absolutely untenable. No expert would have endorsed such an embarrassingly absurd statement. It is not hard to see why the person responsible for having released this article did not want to be named, as Herr Ebeling said.

Report Portrait: Incitement to Hatred

One of the main incidents of the witch-hunt against Gernar Rudolf was the left-wing *Report* broadcast of the German public TV station ARD on April 11, 1994. In the footage by Stefan Rocker, everyone from Conservative to neo-Nazi personalities, including Gernar Rudolf, were thrown all together into one pot. By this sort of undifferentiated reporting, one can produce in certain sectors of the German population a pogrom mood against everything which is or might be right-wing. *Report* showed pictures of a synagogue in Lübeck which had been fire-bombed just a few months before, using the words, that as soon as Auschwitz denial would boom again, synagogues would be burning. The next picture shown in this footage was that of Gernar Rudolf on his way to the Labor Court in Stuttgart. Thereby, Herr Rudolf was made into a sort of paper accomplice of the Lübeck arson. This was strengthened by the commentator's choice of words, when he mentioned the title of the well-known play *Biedermann und die Brandstifter* (Everyman and the Arsonist).⁶⁴³

If that does not constitute criminal incitement of the German television-viewing audience against Gernar Rudolf, what would? It goes without saying that reports of this kind are loaded with pictures of con-

⁶⁴³ In the referenced novel by Max Frisch, Herr Biedermann played just the opposite role of a desk criminal, as he was the victim of a criminal (and his own gullibility). But this fact was not made clear to the viewer.

centration camps, deported Jews, and a sea of corpses in order to ridicule the supposed denial claim of a Germar Rudolf. This is the way the left-wing *Report* works.

But which viewer would know that Rudolf had not only not denied, but had actually denounced the frequent injustices that *did* occur at that time?⁶⁴⁴ And who would notice that the pictures proved nothing except that thousands in the concentration camps died from sickness and malnutrition? Who noticed that no TV program ever showed a film or a picture of a ‘gas chamber’ either in operation or capable of being put into operation – the only point in which Germar Rudolf holds a different viewpoint from media outfits such as *Report*?

Report spewed falsehoods and lies into the world. One of them was seized upon by Franziska Hundseher in her book *Rechte machen Kasse* (Right-Wingers Cash In) and will be dealt with in the next section. Here I will discuss another.⁶⁴⁵

In the appendix of his expert report under the heading *Danksagung* (Acknowledgements), Rudolf had thanked a number of persons and institutions who had helped him in many ways in the collection of data or sources, the recovery and analysis of samples, or for any assistance in the production of the report. Among these were the firms DEGUSSA AG and Institute Fresenius, since the first had supplied important technical data on the stability of Iron Blue and the second had analyzed most of the samples in Rudolf’s presence and initially with his help. Such acknowledgements are usual in scientific publications – also they are polite.

In their commentary, *Report* reproached Rudolf that he had used the names of well-known institutes and firms to give his report the appearance of competence. In view of the facts just given, this reproach is both malevolent and ridiculous. *Report*’s additional assertion that a criminal complaint for fraud had been filed against Rudolf due to this misuse of well-known names, was pure invention. Up to today, January 2003, there have been no criminal complaints from any of the persons or institutions directly or indirectly involved in the production of the report. *Report*’s false accusation was a direct smear.

Stefan Rucker also participated in an *ARD-Tagesthemen* news broadcast on June 6, 1996, covering the book-burning trial of the book

⁶⁴⁴ Cf. G. Rudolf (ed.), *Dissecting the Holocaust*, *op. cit.* (note 24), pp. 31-34.

⁶⁴⁵ There is a detailed discussion of this broadcast in: W. Schlesiger, *Der Fall Rudolf*, *op. cit.* (note 615); there Rudolf disputes that he hid behind the pseudonym Ernst Gauss. He had admitted that during the trial at the District Court of Stuttgart, ref. 17 KLs 83/94.

Grundlagen zur Zeitgeschichte,⁶⁴⁶ edited by Rudolf, then before the County Court of Tübingen. A written version of this piece appeared in the *Frankfurter Allgemeine Zeitung* of June 10, 1996, p. 14. It began with the following sentence:

“Everyman and the Arsonist: diplom chemist German^[647] Rudolf, 31, was sentenced to 14 months imprisonment by the Stuttgart District Court a year ago for incitement to racial hatred and denial of the holocaust.”

Rudolf was also accused of having published a “pseudo-scientific” “hack-job” titled *Grundlagen zur Zeitgeschichte*, whereby he had proven himself a repetitious right-wing extremist offender. It was stated he had left the country and was sought by the police.

The fact that 100 academics had placed an advertisement in the *Frankfurter Allgemeine Zeitung* during the book-burning trial⁶⁴⁸ which criticized the use of censorship and the violation of civil rights by German courts was termed a “frontal assault on the Federal German justice system” in this commentary. Throughout that piece, the authors threw everyone who was politically right-of-center into one big brown bucket.

Ripple Effects

In mid-May 1995, the left-wing political TV show *Panorama* (again from the German public station ARD) reported on several medium-size businesses that had become known as supporters of right-wing circles.⁶⁴⁹ This broadcast was a cinematic presentation of the book *Rechte machen Kasse*,⁶⁵⁰ (Right-Wingers Cash In) written by the journalist who produced the broadcast, Franziska Hundseher. In the book, the author discusses Germar Rudolf or his expert report twice. Both times her discussion is full of errors and falsehoods.

For example, in referring to the invented DPA press release about the alleged instability of cyanide compounds, Frau Hundseher concludes:

“Therefore, this so-called expert report of Herr Rudolf – like the expert report of Frederick A. Leuchter, which similarly found no traces of cyanide in the walls of Auschwitz-Birkenau crematoria 1 and 2 – contains no proof

⁶⁴⁶ Cf. Part II, chapter 5.2. in this volume.

⁶⁴⁷ Should be: Germar. Error in Original.

⁶⁴⁸ Cf. “About true and false perceptions” (www.vho.org/GB/Books/cq/percept.html).

⁶⁴⁹ Cf. *Die Welt*, May 15, 1995: “Unterstützen Unternehmer die rechtsextremen Szene?” (Do Businesses Support the Right-wing Extremist Scene?). As a result of this broadcast, Germar Rudolf’s employer was placed under such pressure from his customers, suppliers, competitors, and employees that he terminated Herr Rudolf’s employment contract.

⁶⁵⁰ Knauer, Munich, May 1995.

of anything other than the methods by which right-wing extremists conduct historical research.”

Though notified in writing about the falsity of the DPA press release she was relying upon, Frau Hundseder never changed her position on this. The same is true for a passage on page 212 of her book, where she claims I had tried to collect several tens of thousands of deutschmarks in order to buy copies of the death books of the Auschwitz camp. She gives the impression that I was trying to get the money. But this is not true. The letter quoted by her had already been distortedly quoted by the above mentioned *Report* journalists who must have illegally received a complete copy of this letter from the trial record. However, if read completely, the letter reveals that I did not want any money, but was asking several personalities to donate money to a third person I had no personal connection with.

The Verdict a Foregone Conclusion

As the trial against Gernar Rudolf in the State Security Chamber of the District Court of Stuttgart began at the end of November 1994, there were several media individuals who distinguished themselves by their painful ignorance of the subject matter of the trial. The cause for this seemed to be that no journalist deemed it necessary to ask for information from anyone involved in the trial. So it happened that repeatedly items were misunderstood or misreported. One might not attribute purposeful distortion to the journalists if it were not for the fact that these misunderstandings were always decidedly unfavorable to Rudolf.

The partisan orientation of the *Süddeutscher Rundfunk*, *SDR*, another public broadcasting station (almost all German public broadcasting stations are left-wing oriented) was exposed when it decided to report only one side of the story, namely that of the investigating police officer. Since his statements were apparently not critical enough for the *SDR*, soon items were invented. The *SDR* took the only two statements from the several hundred pages of correspondence in which Rudolf had mentioned two Jewish personalities in a disapproving way, which were cited by the police officer. *SDR* then asserted falsely, the officer had characterized the rest of my correspondence “as the vilest incitement and defamation.” The *SDR* also attributed to the police officer that he had understood Rudolf to have said he wanted to “rewrite the history of Germany from 1871 onward, without the Holocaust or World War II,” which in view of the absurdity of the statement may cause doubt about

the sanity of the journalists involved. And of course, the *SDR* was silent on the substantial mitigating evidence presented by the defense in the following months.⁶⁵¹

With a few exceptions, the entire media was silent until the end of the trial. It could be seen from the behavior of the journalists present that they were not looking for the real story, but were intent on bringing in a sacrifice for the *Zeitgeist*: all but one of them – a new person from *Südwestfunk* radio – looked only to the prosecuting attorneys and judges in their search for information.

The *Stuttgarter Zeitung* (*StZ*) provides a clear example of the tendentious method of reporting used by the media. Since not enough incriminating material turned up in the several thousand pages of Rudolf's correspondence that were found in the first house search in September 1993, on January 27, 1995, the *StZ* conjured up "writing in the hand of the defendant with indisputable [...] xenophobic content." However, in the whole trial there was never any talk of xenophobia or racism, because there was never any basis for same. At the end of a piece of the *Landesschau* of *Südwest 3* TV station on December 27, 1994, the Christian-Conservative Rudolf mutated into a neo-Nazi: the trial against Rudolf was characterized as another case of a neo-Nazi in the Stuttgart District Court, following a real trial against several National Socialists that had taken place in the same court a short time before.⁶⁵²

That the verdict was assumed to have been decided before the fact became more and more noticeable as the question was raised whether there would be difficulties in convicting Rudolf of the crime he was accused of, as if it were not the task of the court to determine the truth without respect to party, but rather that it should find guilt whether or not the crime had been committed.

The *Böblinger Kreiszeitung* reported in this vein on May 10, 1995, as the trial was nearing its end. There, on page 13 under the headline "Sentence Before Pentecost," one found:

"He [the presiding judge] believes that the prosecuting attorney will conclude her case at the next session on May 18 of this year, and that the sentence against the chemist will be handed down before Pentecost unless something unforeseen happens."

How can it be that, according to this press report, the presiding judge can announce before the end of the trial (it ended on June 23, 1995) that the expected judgment will be *against* the defendant, that it will be de-

⁶⁵¹ *Süddeutscher Rundfunk*, in all four afternoon radio programs on Nov. 25, 1994.

⁶⁵² The video of this program distributed by the *Süddeutscher Rundfunk* was correspondingly labeled with the caption "Neo-Nazi."

cided to his disadvantage? It would have made sense to state that the judgment will be given *in* a case or *about* the defendant. If the journalist here reported the presiding judge's words correctly, the choice of words shows the partisanship of the judge; otherwise it shows that of the journalist.

It is worthwhile to note the relative emphasis the media gave to the pleadings of the prosecution as opposed to that of the defense. On June 13, 1995, the *StZ* reported the arguments of the public attorney in a detailed 3-column story on page 2, while the defense appearance was covered the following day in a small single-column story which merely recapitulated the events of the trial and did not report any of the arguments of the defendant.

To be fair, it should be mentioned that after the sentence came down on June 24, 1995, Sonnhild Maier, the journalist for the *StZ*, mentioned some of the defense arguments:

"The court ruled that the expert report and the preface were a single work and were to be seen as a 'common production' of Rudolf and Remer.

This is what the accused chemist vehemently disputed. He is a practicing Catholic, believes in the political order of the Federal Republic and would never have entered into an association with Remer, whom he took to be a 'living political fossil.' In the chemist's words: *'I would not have been so stupid – this would have undermined me in the final phase of my doctoral program.'*⁶⁵³ *At the time he was preparing his doctoral thesis at the Max Planck Institute in Stuttgart. When his expert report became publicly known, he lost his job."*

In a 3-column story on June 14, 1995, the *Stuttgarter Nachrichten* summarized the prosecution case. The story gave the defense's claims responding to the prosecution's points, but not a single argument supporting these claims. Instead of this, the defense arguments were superficially refuted by the journalist Frank Schwaibold using somewhat erroneous counterarguments.

Against the assertion of the prosecution that Rudolf had revealed himself as a politically motivated criminal by his work under the pseudonym Ernst Gauss and therefore deserved no probation, the defense objected that the Gauss case could not be applied. It was hidden from the reader that in a state under the rule of law a defendant cannot be disadvantaged through a court case that had not even started. In response to the defense counterargument to the prosecution charge that Rudolf cooperated with Remer, journalist Frank Schwaibold asserted

⁶⁵³ Because of the Remer's commented version, the University of Stuttgart refused to give Rudolf an appointment to take the *rigorosum*, the final examination for his PhD title.

falsely that Rudolf had met and talked with Remer three times. The truth is that Rudolf and Remer met only by chance in the course of Rudolf's work as expert witness for Remer's defense attorney. During these accidental encounters, there was no conversation between them, which even the court acknowledged.⁶⁵⁴

Against the defense's assertion that the defendant was no neo-Nazi, the journalist cited a letter absurdly out of context in which Rudolf "referred to the 'Jew Republic Germany' in context with the person Ignatz Bubis." In that letter,⁶⁵⁵ Rudolf criticized a proposal made in spring 1993 that Ignatz Bubis be elected Federal German President. Taking into consideration that Bubis had almost no political experience at that time but had a criminal past, Rudolf commented that the proposal reflected the immense importance that was given to him as the leader of a diminishing minority in the German state (the late Ignatz Bubis was head of the *Zentralrat der Juden in Deutschland*, Central Council of Jews in Germany, at that time). For that reason, Rudolf stated that it was appropriate to rename the name of the German nation, using this minority as a prefix: *Judenrepublik Deutschland* (Jew Republic of Germany).⁶⁵⁶ The Jewish witness Horst Lummert, who testified on behalf of Gernar Rudolf, confirmed before the court on January 9, 1995, that this reasoning was justified.⁶⁵⁷

Given these facts, it remains for Frank Schwaibold to explain to us where neo-Nazism is hidden in Rudolf's remarks.

Execution by Media

Naturally, after the announcement of the sentence of the District Court of Stuttgart, according to which Rudolf was to be punished with 14 months imprisonment without probation, the media found it easy to drag him through the mud. The first was the *Süddeutscher Rundfunk*. Following the imperative of the *Zeitgeist*, without making use of the

⁶⁵⁴ Confidential letter of G. Rudolf to H. Herrmann, Dec. 20, 1992, Computer Data File 2, sheet 222, in records of the District Court Stuttgart, ref. 17 KLs 83/94, introduced Dec. 6, 1994.

⁶⁵⁵ Letter to K. Philipp on March 1, 1993, Investigation File 1, sheet 351, in records of the District Court Stuttgart, ref. 17 KLs 83/94, introduced on Dec. 17, 1994.

⁶⁵⁶ Response of G. Rudolf to accusation May 1994, introduced in trial before District Court Stuttgart, ref. 17 KLs 83/94, on March 17, 1995 in chambers, in records.

⁶⁵⁷ H. Lummert thinks that one should stay with the abbreviation for BRD: "*Bubisrepublik Deutschland*" (Bubis Republic Germany). Approximately 30 witnesses testified that they had never heard Gernar Rudolf make anti-Semitic remarks and that he had even protested against their use. There was no contrary testimony. The media likewise ignored a speech at an academic fraternity by Rudolf to students which was clearly pro-Jewish. On May 9, 1995, the court verified that the speech had taken place.

decision of the court or any other evidence, it labeled Rudolf a “neo-Nazi.” It also attempted to make the Rudolf expert report ridiculous by resurrecting the DPA notice from a year before. *SDR 3* simply claimed that it was known to competent chemists that cyanide compounds disintegrate within a few weeks in rocks.⁶⁵⁸

The program *Landesschau* of the regional television station *Südwest 3* made comments similar to those of *SDR 3*, but piled even further on the defamation by misrepresenting an article that appeared in the *Stuttgarter Nachrichten* the week before. This article of June 14, 1995, was entitled “Only a Victim of the ‘Father-figure of Neo-Nazism’?” Under the word “Neo-Nazism,” a picture of the defendant was shown. The question raised by this newspaper headline was whether Rudolf had been a victim of O. E. Remer, who was identified as the “Father-figure of Neo-Nazism.”

In filming a copy of this article, the *Südwestfunk* bent the paper so that the viewer would see only the words “Father-figure of Neo-Nazism” over the photograph of Rudolf. The viewer would unavoidably receive the impression that the harsh sentence on Rudolf was a judicial determination that with Rudolf one was dealing with the father-figure of Neo-Nazism. It is difficult to imagine how media distortion could get any worse.

Many media sources considered the sentence handed down by the court as an insufficient condemnation of Rudolf, as can be seen from several examples. On June 24, 1995, the *Böblinger Bote* wrote that Rudolf could be linked to National Socialist race doctrine. This complete fabrication is so absurd and so far from any reality that it was never an issue during the course of the trial, nor was it mentioned in the court’s spoken opinion giving the basis for the written verdict. Unfortunately, this did not hinder the court from inserting this unfounded assertion into the written verdict for the sentence.⁶⁵⁹

On the same day, and despite Rudolf’s personal appeal, Frank Schwaibold of the *Stuttgarter Nachrichten* could not help but once again misconstrue the contacts between Rudolf and Remer, in that he wrote, Rudolf had been “provably in personal contact with Remer three

⁶⁵⁸ *SDR 3*, June 23, 1995, 13:30 hours.

⁶⁵⁹ Verdict of the District Court Stuttgart, ref. 17 KLS 83/94, pp. 15, 156ff. As evidence the court used an unpublished writing of the defendant. In it, Rudolf commented how the confirmation of revisionist theses might cause many to disdain Jews. Records of the District Court Stuttgart, ref. 17 KLS 83/94, Computer Data File 3, introduced on Jan. 26, 1995. Where there is racism in these speculative remarks is unclear.

times,” where the word “personal” imputed a relationship between the two that had never existed.

On June 24, 1995, the *Süddeutsche Zeitung* outdid itself in manipulating the news. It wrote that Rudolf had occasionally been a member of the right-wing extremist Republican Party. But, in fact, Rudolf had been a member of the party at a time when it was not considered “right-wing extremist” and even important members of the semi-conservative Christian Democrats (CDU/CSU) maintained contacts with members of the party. Whatever opinion the media and the German internal secret service, the Office for the Defense of the Constitution (*Verfassungsschutz*) had after Rudolf left the party in summer 1991 cannot be taken as a criterion for the evaluation of Rudolf’s political views. Also, Rudolf was not on trial for his political beliefs, which, according to Article 3, Para. 3 of the German Basic Law can never be cause for deprivation of rights. Finally, it is absurd to try to associate the patriotic-conservative views of the Republicans with the National Socialist views of Remer, which was clearly the intention of the *Süddeutsche Zeitung*.

The *Süddeutsche Zeitung* also was the only one of Germany’s bigger daily newspapers that again trotted out the fable of the supposedly long-ago refuted Rudolf expert report, based on the DPA notice:

“According to information from competent chemists, hydrogen cyanide compounds disintegrate within a few months from the effects of weather and are no longer detectable.”

With this perpetual falsehood, the point was made to every uninitiated reader that the Rudolf expert report was the technically worthless hack-job of an incompetent chemist. At the beginning of the trial on November 23, 1994, the *Böblinger Bote* had spread the same nonsense:

“According to expert opinion, no traces of cyanide can be found after 50 years since they disintegrate quickly.”

In their report of 1997, p. 64, even the Bavarian Office for the Protection of the Constitution (*Bayerisches Amt für Verfassungsschutz*) has the nerve to repeat that nonsense.

In view of the supposedly proven pseudo-science in the Rudolf expert report, the newspapers avoided the words “expert report” or printed them in quotation marks and also characterized it as a “hack-job” (*StZ*, November 23, 1994). However, on that date, November 23, 1994, the court declared that it did not consider itself competent to decide to what extent the expert report satisfied scientific criteria. It avoided the issue of scientific evidence by attributing to Rudolf the preface and epilogue

written by Remer's friend in Remer's version and sentenced Rudolf on that basis.

In a wider context, Hans Westra, Director of the Anne Frank Foundation in the Netherlands, has commented on the technical correctness of the Rudolf expert report. The Anne Frank Foundation is one of the most well-known of the institutions world-wide that occupy themselves with uncovering and documenting proofs of the Holocaust. In response to the question of a journalist as to whether the scientific conclusions of the Rudolf expert report were correct, Hans Westra replied:⁶⁶⁰

"These scientific analyses are perfect. What one cannot determine is how this Rudolf got them, how he obtained the samples."

Certainly Mr. Westra could not restrain himself from casting doubt on the authenticity of the samples, since established researchers seem to be able to find no other loop-hole in the scheme of arguments in the Rudolf expert report.

News for Public Instruction

The day of the announcement of the sentence in the case of Germar Rudolf may be the only one in which the media outside the local region reported on it. As mentioned above, the *Süddeutsche Zeitung* devoted an extensive story to the sentence.

Also, on June 23, 1995, the nationwide TV news show *heute* of the ZDF (German public Television 2) felt called on to write a short story reporting that the diplom chemist Germar Rudolf had been sentenced to 14 months imprisonment without probation on account of an expert report on the gas chambers of Auschwitz. Since as the media outside the local region had reported almost nothing on the case previous to this, the normal television viewer would hardly know what to do with this very brief piece of information. Therefore, the report can have had only one purpose: It should be made clear to every potential technical witness Republic-wide that those who voice views about the Holocaust complex that deviate from those officially allowed – however factually correct, reputable, scientific and perhaps even professionally correct – will be thrown in jail without probation.

The news reports of the local press on May 6, 1996, ran in the same direction after my application for a revision of the verdict was turned down by the German Federal Supreme Court. They hinted to the reader that the scientist Rudolf had been sentenced because of his expert re-

⁶⁶⁰ BRT 1 (Belgian Television), *Panorama*, April 27, 1995.

port, which had come to an incorrect conclusion and thereby denied the Holocaust. It apparently did not interest anyone that the expert report had not been an issue at the trial. Naturally, the *Böblinger Bote* could not restrain itself from digging up the DPA lie again:⁶⁶¹

“In opposition to competent scientific authorities, the Jettingen chemist asserted that mass-killing of humans with hydrogen cyanide would leave traces of cyanide in the masonry of the remaining buildings in the camp, but no such traces can be found.”

That the extremely harsh sentence against Rudolf was due to reasons of public instruction, and thus for the purpose of frightening any scientist who might play with the idea of publishing a deviating opinion (general prevention), was also the opinion of the *Böblinger Bote* on June 27, 1996:

“No probation was granted for the sentence of 14 months imprisonment handed down in June last year on grounds of general prevention.”

Hunted Abroad

In March of 1996, Gernar Rudolf went into exile. The press initially lost track of him and for the time being, lost interest as well. This changed in the fall of 1999, when British journalist Chris Hastings (34) set about tracking him down in England. Since Rudolf had registered, as required by law, and residency records are open to the public, it was not difficult to establish that Rudolf was residing in England. In addition, Rudolf had listed his post office address on his website (PO Box 118, Hastings TN34 1YL). Chris Hastings succeeded in locating the apartment in which Rudolf was registered. He left a note requesting an interview. Rudolf granted his request by allowing him a two hour interview at Victoria station in London. The content of this interview concerned primarily the present state of human rights in Germany as well as the official persecution of Rudolf. But as Rudolf suspected, Hastings was not interested in the present state of human rights in Germany. In Hastings' article in the *Sunday Telegraph* of Oct. 17, 1999, the subject was not even mentioned. Instead, under a subtitle demagogically slandering Rudolf as a “neo-Nazi,” Hastings wrote:⁶⁶²

“He [Rudolf] confirms that, during his stay in Britain, he has forged links with far-Right extremists including members of the National Front and the British National Party.[...]”

⁶⁶¹ *Kreiszeitung Böblinger Bote and Gäubote/Südwestpresse-Verbund*, May 6, 1996.

⁶⁶² Jessica Berry and Chris Hastings, “German neo-Nazi fugitive is found hiding in Britain,” *The Sunday Telegraph*, Oct. 17, 1999; repeated on Oct. 18, 1999 in the *Independent*.

‘In Britain I work as an Holocaust revisionist 24 hours a day. My work has brought me into contact with people on the far Right. I have met leading members of the National Front and the British National Party while I have been in England.’”

In the worst tradition of yellow journalism, Hastings took individual words and phrases totally out of context and rearranged them to suit his sensationalistic purposes. Rudolf never uttered such sentences, with the exception of the sentence about working 24 hours a day for revisionism. It is a fact that, in the spring of 1999, Rudolf met with Nick Griffin and discussed Griffin’s experiences with the British justice system. The year before, Griffin was, among other things, accused of having published an article with revisionist statements in a small right-wing periodical edited by himself, but he had been acquitted. Because of Rudolf’s own exposed position, and because he had extensively reported on official censorship in his publication *Vierteljahreshefte für freie Geschichtsforschung (VffG)* before, Rudolf was naturally very interested in Griffin’s story, but he was not interested in Griffin’s organizational memberships or functions. Before this meeting, Rudolf was not aware that Griffin held a leading position in the nationalist British National Party. However, during the meeting, Griffin informed him that he aspired to chairmanship of the party, to which position he was subsequently elected. When asked by Hastings whether he was in contact with members of the political right, Rudolf straightforwardly told him of the conversation with Griffin. Hastings used this to suggest to his readers that Rudolf had forged contacts with the organizational leadership of the leading rightwing extremist parties of England. But to the best of his knowledge, Rudolf has never made contact with any member of the National Front.

Hastings went so far as to interview Rudolf’s former landlady, whom he absurdly quoted as follows:

“Sheila Evans, Rudolf’s former landlady, said: ‘I remember he said he was a writer working for journals in Germany. I was struck by how clean he left the house when he left. He stripped it bare. I think he was trying to cover his tracks.’”

In fact, when he negotiated the tenancy contract in July 1996, Rudolf had told his landlady that he will write for a German periodical. (*VffG* first appeared in spring of 1997, published by the Flemish organization Vrij Historisch Onderzoek). Mrs. Evans was the most ferocious house-dragon that Rudolf ever met. When Rudolf moved out, he had to repair and repaint every little scratch on the skirting boards, every bit of chipped enamel on door frames and heaters, every tiny dent in the walls

before she would return his deposit. Surely it was normal behavior for Rudolf to take his belongings with him when he moved out. It seems that when people read about their neighbors in the newspapers, they see ghosts and goblins everywhere.

Chris Hastings continued to make Rudolf's presence and activities known to a very large number of nosy and peculiar people. He prompted them to agree that England needs a law to protect holocaust lore against scientific examination. And he prompted them to agree that Rudolf should be extradited to Germany immediately.

The results were not long in coming. The established media in Germany ground out another sensationalistic story. "Indicted Neo-Nazi in Great Britain," blared the DPA (German Press Agency) on October 18, 1999 (it was printed on the 19th in *Die Rheinpfalz* and other newspapers.) "Holocaust denier hiding out in England" announced the leftwing *Stuttgarter Nachrichten* on October 21, page 4. On October 31, Chris Hastings jubilantly announced in the *Sunday Telegraph* that Germany would now seriously pursue Rudolf's extradition. He predicted that England would comply because Rudolf had not been convicted for holocaust denial, but for incitement to racial hatred, which is a violation of English law, too.⁶⁶³ On October 22, the local press in Hastings, where Rudolf resided, chimed in with "Fleeing neo-Nazi uses base in Hastings" (*The Hastings and St. Leonards Observer*). The monthly English manhunter tabloid *Searchlight* joined the hunt in December with "Auschwitz liar hides out in Britain" on page 13.⁶⁶⁴ Chris Hastings added more wood to the flames in his update of January 16, 2000:

"Neo-Nazi accused of 'racial hatred' goes on the run. [...] Germany has issued an international arrest warrant for Gernar Rudolf, who fled to England to escape a prison sentence for inciting racial hatred."

The manhunt turned completely into hysteria with a BBC report about Rudolf on March 28, 2000, which was repeated the day after by the south English regional TV station ITV. Six or seven photographs of Rudolf were shown during the report which had been taken from Rudolf's website www.vho.org. The public was warned to beware of this "Nazi sympathizer." The audience must have gained the impression that Rudolf was so dangerous that he was running around murdering people. Mr. Michael Whine of the British Jewish Board of Deputies was pleased to appear before the cameras and announce that regarding Rudolf, England was dealing with a "new breed of dangerous Nazis." The

⁶⁶³ This was echoed, e.g., by the *Australian Jewish News*, Nov. 5, 1999.

⁶⁶⁴ The German matching piece to this periodical, *blick nach rechts*, started its campaign as late as June 2000 with a contribution by Thomas Pfeiffer in the same style, of course.

local press chimed in once more with “Escaped Neo-Nazi still hiding in Hastings [...] he [...] was still being hunted.” (*The Hastings and St. Leonards Observer*, March 31, 2000). Obviously, the powers that be are striving to familiarize the local populace with Rudolf’s likeness and condition them to be afraid of him. It wants them to complain to the police about the desperado in their midst.

On May 27, 2000, Günther Hoerbst of the *Hamburger Abendblatt* reported on a report of the Israeli university of Tel Aviv entitled *Anti-Semitism Worldwide 1998/99*:

“Twelve pages of the report are dedicated to Germany. The report complains about the growing acceptance of the holocaust lie, primarily by means of the internet and rightwing extremist groups. The report acknowledges that present German legislation provides the most ‘advanced and effective attempts at combating the holocaust lie,’ but ‘it nevertheless is a growing phenomenon.’ For instance, the leading German holocaust liar Rudolf continues to disseminate his writings over the internet from foreign countries, even though he has been convicted and sentenced in Germany.”

What a pity that is!

So far, the only more or less impartial article about Rudolf has appeared on January 7, 2000, in the *Los Angeles Times*, in connection with the Irving vs. Lipstadt trial. It was written by Kim Murphy.⁶⁶⁵

Freedom of the Press = A Truthful Press?

Against several of the above-mentioned media pieces, namely those where the person of Gernar Rudolf himself had been attacked, it would have been possible to demand a right of reply in the press. However, with respect to factually false assertions such as the fabricated DPA notice which did not touch Rudolf personally, there can be no recourse under current law.

The District Court of Stuttgart sentenced Gernar Rudolf to 14 months imprisonment without probation for the reasons that Rudolf was deeply marked with anti-Semitism, that he was entangled in a revisionist and right-wing extremist environment, and that he was obviously a fanatical, politically motivated criminal. In that moment, the court gave the media license to vilify and malign him without let or hindrance, since in the Federal Republic of Germany, anyone labeled as an anti-Semite or right-wing extremist is a de facto outlaw. That the court did not find that Rudolf was a right-wing extremist, merely that he had had dealings with supposedly “right-wing extremist” persons, was of sec-

⁶⁶⁵ Online at: www.germarrudolf.com/persecute/docs/ListPos111.pdf.

ondary importance and in view of the media practice of imputing guilt by association no cause to hold back. Rudolf's applications for rebuttal in the press were denied out-of-hand, since in the meantime the version of the story spread by the press had been confirmed by the courts.

In a democracy, the people are the sovereign. Should the voice of the people become the voice of God not only with respect to power, but also partly with respect to infallibility, care must be taken that the people are comprehensively and truthfully informed. In this modern information age, the media play the central role in forming the public will. For this reason, it must be guaranteed that the people are comprehensively and truthfully informed.

The intentional presentation of false and one-sided information to the public must automatically lead to false conceptions of reality and thence to unwise political decisions. The intentional presentation of disinformation through suppression of news or spreading of false news should be considered one of the most serious crimes of a political nature that can be committed in a democracy.

The question of the executive and judicial means by which the people can be guaranteed to be kept comprehensively and truthfully informed is bound to be a difficult one in view of the fundamental freedoms of press and speech. It would be necessary to require, for example, that the media be subject to democratic control in that the formation of political or economic monopolies would be prevented. One proposal would be to allow access to the media in their area of operations to political parties proportional to the vote they received or to socially-concerned organizations (such as religions) proportional to their membership, without a limiting minimum percent.

Also the right of reply in the press should be expanded such that it should apply not only when a person's reputation is harmed, but also when it can be shown that a news item is grossly one-sided or wrong, and that the truth itself has been harmed.

The criminal prosecution of persons of whom it can be proven that they deliberately composed and distributed false information is problematic, since the proof of the assertion that a journalist deliberately spread false news – that he lied – could only rarely succeed. The simple assertion that the journalist must have known that his report was not true since all others knew it should never suffice.⁶⁶⁶

⁶⁶⁶ This is the trick used to send revisionists to jail: Since everyone knows that the Holocaust happened, revisionists must know it also. When they still assert the opposite, they must do so wittingly and therefore they lie. Whoever lies has evil intentions and therefore belongs behind bars. Such is the logic of terror.

After all, I think we do not need laws to censor liars, but laws that punish censors. That alone can be a remedy for the escalating censorship in modern Europe.

“Thank heaven, we live under the rule of law. But unfortunately, that does not apply to the territory of the Federal Republic of Germany.”

Johannes Gross, *Capital*, Germany, Nov. 1994, p. 3

7. Outlawed in Germany

The Disfranchisement of Unwelcome Citizens⁶⁶⁷

In antiquity and in the Middle Ages, many European nations possessed the legal power to disfranchise citizens for gross misdeeds. With the rise of secularized constitutional nations, the use of this power disappeared until it resurfaced in the 3rd Reich as thought-crime laws. In the Federal Republic of Germany, the possibility of far-reaching revocations of civil rights was built right into the constitution in Article 18 of the Basic Law, but until recently no use was made of it. Jochen Lober has shown that the equivalent curtailment of the civil rights of citizens has been achieved by extra-constitutional regulation.⁶⁶⁸ We will examine here Lober’s question, whether a form of *de facto* outlawry was introduced with the revision of section 130 of the German Penal Code, which made any kind of Holocaust denial – or revisionism – and opposition to multi-culturalism a potential criminal offense punishable by up to five years in prison. This will be done by studying the fate of Auschwitz researcher Diplom-Chemist Germar Rudolf. What happened to him will be examined phenomenologically, not chronologically, in order to focus on the effects of German criminal law on the civil rights of German citizens.

First Step: Denunciation

From September 20 to 22, 1991, a seminar took place in Nuremberg (Bavaria) on Holocaust revisionism, sponsored by the libertarian Bavarian Thomas Dehler Foundation.

Among the participants, besides Germar Rudolf, there was a certain Diplom-Physicist Hermann Körber from Bünde, in northern Germany. His behavior during the seminar was highly unpleasant. During a discussion period, for example, he stated that the German people should

⁶⁶⁷ Written after reading the mentioned article by J. Lober (next footnote); first published in *Staatsbriefe* 12/95, Castel del Monte, Munich, pp. 10-15.

⁶⁶⁸ *Staatsbriefe* 7/95.

not only be considered as murderers, but as plunderers as well. He also suggested that the Germans themselves were to blame for the many deaths among old people, women and children that were caused by the Allied aerial bombardment, because they had started the bombing (which is not true) and had knowingly failed to evacuate the civil population (which was also not true, since many children were sent to the country). During the Sunday dinner, Körber threatened a fellow participant sitting at his table with a dinner knife because the person did not share his opinion on the Holocaust, and at the close on Sunday afternoon, he loudly called the participants Gernar Rudolf and Winfried Zwerenz pigs, because they had disagreed with him on scientific grounds.

On November 5, 1992, this Hermann Körber filed a criminal complaint with state attorney Baumann in Schweinfurt against Gernar Rudolf for instigating Otto Ernst Remer to incitement to racial hatred.⁶⁶⁹ He claimed that it was Rudolf and his expert report that had caused Remer to begin publishing material on the Holocaust in his *Remer Depesche*.⁶⁷⁰ Subsequently, the state attorney of Schweinfurt initiated a criminal investigation against Rudolf on grounds of incitement to racial hatred, and others, in which O. E. Remer was also named.⁶⁷¹ Both defendants denied the accusations.

Then, on April, 19, 1993, at the state attorney's office in Bielefeld, Körber filed a witness affidavit in which he stated:⁶⁷²

"As a Diplom Chemist, Rudolf knows and must know that his theses are scientifically untenable.

It can be proven that that which Rudolf convinced Remer of is trickery."

On April 27, 1993, as proof of his assertion that Rudolf was knowingly deceitful, Körber filed another affidavit in which he interpreted Rudolf's technical arguments made in an exchange of correspondence with Werner Wegner, as incitement to racial hatred, and characterized Rudolf's assertion that unambiguous technical evidence was superior to ambiguous documentary evidence as "unscientific and unprofessional procedure."⁶⁷³

In another affidavit made on April 30, 1993, Körber asserted falsely that Rudolf supported

⁶⁶⁹ Investigation File 1 in the trial against Gernar Rudolf, District Court of Stuttgart, ref. 17 KLs 83/94, sheet 15.

⁶⁷⁰ The *Remer Depesche* had already appeared in Spring 1991, before Rudolf had begun his research as expert witness.

⁶⁷¹ Ref. 8 Js 13182/92, Investigation File 1 (District Court Stuttgart, ref. 17 KLs 83/94), sheet 17ff.

⁶⁷² *Ibid.*, sheet 58.

⁶⁷³ *Ibid.*, sheet 63

“the Leuchter thesis that there was a danger of explosion throughout the Auschwitz compound, at least for structures, whenever gassing operations with Zyklon B were going on.”

Rudolf had in fact stated that the use of high concentrations of Zyklon B to reduce execution periods to minutes or seconds, as the witnesses had reported, would mean that there would be safety problems due to explosive concentrations of hydrogen cyanide (see chapter 6.3.). He had never spoken nor written of a general danger of explosion.

The busy witness Körber was at it again on May 26, 1993, this time to assert that the references to the Rudolf Report in various editions of the *Remer Depesche* proved that the author Rudolf was the cause. Körber also claimed that Rudolf’s attempt to testify as an expert witness, which was refused by the court, constituted conspiracy to commit perjury.⁶⁷⁴ On June 7, 1993, he repeated his accusations that Rudolf had instigated Remer to his misdeeds in the *Remer Depesche*, and offered evidence that would defer the possible termination of the investigation.⁶⁷⁵

It should be pointed out that there is no mention among Körber’s statements of the fact that Rudolf had written him a lengthy letter in January 1993, in which Rudolf presented detailed arguments supporting the conclusions of his report.⁶⁷⁶ Körber had never answered the letter. His only response had been to make false accusations about Rudolf to the police.

In mid-April 1993, the state attorney of Stuttgart set in motion another prosecution against Rudolf in addition to the ongoing prosecution concerning incitement. This one was initiated by retired Generalmajor O. E. Remer’s distribution of a commented version of the Rudolf Report.

The first copies of Remer’s version were sent to various notable personalities in politics, justice, and science on April 16, 1993.⁶⁷⁷ On the same day, Prof. Dr. Hanns F. Zacher, President of the Max Planck Society (Max-Planck-Gesellschaft, MPG), received a call from the Chairman of the Directorate of the *Zentralrat der Juden in Deutschland* (Central Council of Jews in Germany), Ignatz Bubis, in which Herr

⁶⁷⁴ Investigation File 1 (District Court Stuttgart, ref. 17 KLs 83/94), sheet 84f.

⁶⁷⁵ *Ibid.*, sheet 86.

⁶⁷⁶ In the exhibits of the trial against Rudolf (District Court Stuttgart, ref. 17 KLs 83/94), Correspondence File K. Rudolf had added thanks for Körber’s Christmas present – his criminal complaint.

⁶⁷⁷ Gernar Rudolf’s doctoral supervisor, Prof. Dr. Dr. h. c. H. G. von Schnering, as well as several other professors at the Max Planck Institute for Solid State Research received Remer’s version on this day: decision, District Court Stuttgart, ref. 17 KLs 83/94, p. 126.

Bubis told Prof. Zacher of his concern about the effect of the Rudolf Report by Diplom-Chemist Gernar Rudolf, at that time an MPG employee.⁶⁷⁸ It is not known what Prof. Zacher did in response to the call. In any case there was no attempt by the MPG administration to terminate Rudolf's employment at that time.

In mid-May 1993, Rudolf received at his office two calls from journalists (the German weekly magazine *stern* and the private TV station *SAT 1*) dealing with the distribution of the Remer version. During one of these calls, a colleague of Rudolf was in the room. The colleague later told another colleague, Jörg Sassmannshausen, who immediately reported the event to the executive Director of the Max Planck Institute, Prof. Arndt Simon.⁶⁷⁹ Subsequently, Rudolf was asked not to appear at the Institute anymore unless at the explicit request of his doctoral supervisor, Prof. Dr. H. G. von Schnering, in order to make sure that there might be no further contact with journalists during work hours. His employment contract had not been mentioned.

This request was subsequently repeated in writing. Nine days afterwards, Rudolf entered the Max Planck Institute in order to copy some documents and to discuss the reproduction of his doctoral thesis with his doctoral supervisor. He deliberately avoided his office in order to avoid being confronted with questions from the media. Rudolf was seen by Institute workers, however, and they reported his presence to the executive director.

Second Step: Professional Ruin

Rudolf had neglected to ask his doctoral supervisor for permission to enter the Institute. The following day he was asked to accept termination of his employment contract without notice.⁶⁸⁰ The justification for this was primarily that Rudolf had sent letters on stationary with the Max Planck Institute letterhead while working on the Report. Rudolf

⁶⁷⁸ A later letter of the Central Council of Jews to the President of the MPG on June 22, 1993, refers to this telephone call. Facsimile published in Wilhelm Schlesiger, *Der Fall Rudolf*, *op. cit.* (note 615); from the records of the Labor Court Stuttgart in the case *Rudolf v. Max Planck Institute for Solid State Research*, ref. 14 Ca 6663/93.

⁶⁷⁹ According to information from his secretary, Prof. Simon knew what role he was being forced to play, but for opportunistic reasons he put his career and the reputation of the Max Planck Institute ahead of upholding the principles of scientific research; information received from my former wife who at that time still worked at this institute. On this affair, cf. also Prof. Simon's revealing statements and the discussion on the social taboo that must be observed by German scientists in: W. Schlesiger, *Der Fall Rudolf*, (note 615).

⁶⁸⁰ This description is based on the transcript of Rudolf's testimony from memory from this time, Computer Data File 2, (District Court Stuttgart, ref. 17 KLS 83/94), 175-220.

had privately engaged the Fresenius Institute to analyze the wall samples from Auschwitz for traces of cyanide. But when the Fresenius Institute was already working on his samples in Rudolf's presence, he handed in a letter typed on a letter head of his employer with a detailed specification of the work to be conducted by the Fresenius Institute and a detailed description of the samples. Though the unauthorized use of official letterheads for private purposes was widespread at the Max Planck Institute at the time, in Rudolf's case it became a no-no. It was this use of Institute letterhead, about which the management of the Institute first became aware through news reports,⁶⁸¹ that established the connection of the Institute with the Rudolf Report.

Apparently because of the failure of the MPG to respond to the intercession of I. Bubis (see above), on June 22, 1993, the *Zentralrat der Juden in Deutschland* (Central Council of Jews in Germany) felt it necessary to notify the President of the MPG that he was expected to take appropriate measures to restrict the activities of Report researcher Germar Rudolf. On July 14, 1993, the President of the MPG informed the Central Council that the MPG had no further responsibility for the activities of Herr Rudolf, since he had been fired.

The subsequent labor court proceeding instituted by Rudolf against the Max Planck Institute with respect to his termination without notice turned on the question, whether the generally-practiced and, in his case, already known infraction "private use of official letterhead" could be used as grounds for dismissal without notice when the Auschwitz issue was mixed in. Labor court judge Stolz made it clear that an employer could dismiss an employee anytime who held such views as the plaintiff Germar Rudolf. This amounts to the principle that Rudolf and others who think like him are outlaws with respect to the labor law. For reasons of social concern, the Max-Planck-Institute offered to make an agreement with the plaintiff out of court, by which the termination without notice would be revoked and at the same time replaced by a mutual agreement that the employment contract would be terminated, barring further recourse.⁶⁸²

Despite this dispute between Rudolf and his now former employer, his doctoral supervisor Prof. H. G. von Schnering continued to support his doctoral candidate and in July 1993 certified that Rudolf possessed

⁶⁸¹ *Wiesbadener Kurier* on 8./9. and 13. May 1993.

⁶⁸² Labor Court of Stuttgart, ref. 14 Ca 6663/93. A detailed description of the events in the Max Planck Institute and elsewhere about the Rudolf report during the year 1993, with a series of reproduced documents, can be found in the brochure W. Schlesiger, *The Rudolf Case, op. cit.* (note 615).

the necessary professional and ethical qualification to take the next step, the final examination called the Rigorosum. In that month, Rudolf submitted to the University of Stuttgart his doctoral thesis with all necessary supporting documents and applied for admission to the Rigorosum. By fall 1993, however, permission for the promotion had still not been granted. On inquiry at the University, Rudolf was told that his application had been put on hold because of the criminal investigation initiated against Rudolf for incitement to racial hatred as well as that against O. E. Remer for distribution of Remer's version of the Rudolf Report. The University of Stuttgart maintained that it was questionable whether the candidate possessed the necessary ethical qualification.

The grounds for this decision was section 4 of the Law On Academic Degrees, enacted by Adolf Hitler in 1939 and still in force in Germany today. By this provision, an academic degree can be revoked or withheld, if one does not possess the necessary ethical qualification. According to a decision of the Administrative Court of Baden-Württemberg, an academic title can only be withheld when there has been a judicial sentence for a serious crime that has been entered on the person's police record of conduct.⁶⁸³

Since at the time of his application for admission to the Rigorosum 1) Rudolf had not been judicially sentenced and 2) such a decision was not expected by him, Rudolf filed a complaint against the University of Stuttgart in the County Court of Stuttgart for failure to act. At the behest of the University of Stuttgart, the County Court Stuttgart stalled on grounds that the ongoing criminal proceeding against Rudolf would have to be concluded before it could be decided whether Rudolf possessed the necessary qualifications for promotion.⁶⁸⁴

After the sentence against Rudolf was handed down in March 1996, the University of Stuttgart advised him that it was in his best interest to withdraw his application for promotion, since otherwise the University most likely would refuse his application because of Rudolf's conviction for a severe crime. Rudolf complied, because he might otherwise have

⁶⁸³ Ref. IX 1496/79, decision on March 18, 1981. At that time, a person who had been convicted to five years imprisonment for a drug offense, which was entered in his police record, was certified as *having* the necessary ethical qualification, and the University was ordered to admit him to the final PhD exam. In this decision, it was held that this Hitler law is still in effect because it does not contain National Socialist thinking and should be considered as having been legally enacted.

⁶⁸⁴ Ref. 13 K 1329/94. After the prison sentence against Rudolf was announced, Rudolf's doctoral supervisor commented that he would have to sit out his punishment before he could complete his doctoral program. Hence, Prof. von Schnering was at that time apparently still ready to stand behind his candidate.

to reckon with the problem that his doctoral work might be unacceptable everywhere else in the world.⁶⁸⁵

By good fortune, in fall 1994 Rudolf obtained a position as a field representative with a firm dealing in corrosion inhibiting products. During her research into “right-wing businesses,” left-wing journalist F. Hundseder stumbled onto the fact that Rudolf was employed at one of them. In the ARD broadcast *Panorama* in mid-May 1995, this discovery was described as a scandal, and both the company and their employee Rudolf as heinous Neo-Nazis. The company came immediately under such heavy pressure from customers, suppliers, employees and competitors that by mutual agreement they and Rudolf terminated his employment contract in order to prevent further loss to the company. Due to this denunciation by the media, Rudolf lost his job within a few days.

In the current state of German labor law, if in future applications for employment Rudolf were not to mention his revisionist activities and this were to become known to his employer, it would be considered grounds for dismissal. If he duly mentioned these activities, however, he could expect not to find any ordinary employment anywhere in Germany.⁶⁸⁶

Third Step: Persecution through Prosecution

A more complete analysis of the prosecution against Rudolf will be left to other works. Rudolf was accused not only because of Remer’s political commentary, which was falsely attributed to Rudolf, but also because of the purely technical conclusions in his Report.⁶⁸⁷ In the principal hearing Presiding Judge Dr. Dietmar Mayer stated that the competence of the court did not extend to the evaluation of the scientific validity of the expert report. Because of this, the contents of the expert report were not addressed in the proceeding, but only the question whether the defendant was responsible for Remer’s commentary.

In its decision, the court made no secret of the fact that it held revisionist thinking itself to be reprehensible and punishable by increasing the severity of the sentence.⁶⁸⁸ However, the sentence against Rudolf to 14 months prison without probation was based on the false contention

⁶⁸⁵ See the letter of the University as well as Rudolf’s reaction (in German only online: vho.org/Authors/UniStgt.html and vho.org/Authors/RudolfUniStgt.html).

⁶⁸⁶ There remained the non-ordinary way that he has followed successfully until 2005.

⁶⁸⁷ Criminal indictment by the States Attorney of Stuttgart on 19. April 1994, ref. 4 Js 34417/93.

⁶⁸⁸ Trial District Court Stuttgart, ref. 17 KLS 83/94, decision p. 239.

that Rudolf had at least knowingly contributed to the political commentary contained in Remer's version of his expert report. The court justified its sentence with a tiresomely assembled chain of proofs amounting to 240 pages which in decisive points departed from the actual evidence and which completely ignored the contradictory evidence on the main point of the defense.

The chemical and construction problems of the buildings at Auschwitz dealt with in the Rudolf Report were characterized by the court as "hardly clarifiable details of the National Socialist mass-crimes," thus, under no circumstance a matter of "common knowledge."⁶⁸⁹

Rudolf's trial on account of the business with Remer's version ended in summer 1995. Under which star this trial was held was made blindingly clear by a document from the trial records: Rudolf's judges in the District Court of Stuttgart wanted to prevent that they themselves should come under the wheels of denunciation and inquisition, as had the judges of the District Court of Mannheim in the Günter Deckert Case, who were massively criticized by media and politicians, threatened with prosecution, and eventually sent to early retirement because they had dared to call a leading revisionist a man of good character and sentence him only to one year imprisonment *with* probation. Before the opening of the trial against Rudolf, the judges therefore carefully inquired with the German Federal Supreme Court with respect to its decision against Günter Deckert and receive an immediate reply.⁶⁹⁰ Since the German Federal Supreme Court revised the Deckert decision so many times until a sentence of imprisonment without probation was certain, it is obvious that in the Rudolf Case the same sentence of imprisonment without probation was the only option if the judges wanted to stay out of trouble.

At the same time as the above-mentioned prosecution, there were three other prosecutions underway against Rudolf. In the first case, he was accused of being mainly or at least partially responsible for the publication of the journals *Remer Depesche* and *Deutschland Report*.⁶⁹¹ The second involved his publication of the work *Grundlagen zur Zeitgeschichte* (see Part II., chapter 5.2.). The third was directed against an exchange of correspondence between Rudolf and the Krakow Institute

⁶⁸⁹ *Ibid.*, decision p. 15.

⁶⁹⁰ *Ibid.*, Letter of the 17th Criminal Justice Chamber of the District Court of Stuttgart to the Federal High Court (BGH) on April 21, 1994. Investigation File 2, sheet 768. Answer of the Federal High Court on April 26, 1994 with enclosure: decision on March 15, 1994 re: G. A. Deckert, ref. 1 StR 179/93.

⁶⁹¹ Böblingen County Court, ref. 9 Gs 521/94. This case was later dropped due to lack of evidence.

for Forensic Research on chemical questions concerning the gas chambers of Auschwitz that was published in *Sleipnir*, issue 3, 1995.⁶¹⁷

It was clear already then that these would not be the last measures taken against Rudolf, especially since he intended to defend himself in print. In view of the fact that the District Court of Stuttgart was able to find the defendant guilty contrary to the evidence, one could justifiably fear that in each outstanding trial, the innocent defendant would be found just as guilty, and that he would find himself incarcerated under the terms of several sentences of increasing severity.

In the meantime, Rudolf's home had been searched three times, and each time books, archives, correspondence, technical data and his computer equipment were seized. The principal loss was not that of physical items, but the intellectual loss of data and archive material. The result was that Rudolf could no longer work as a scientist and also could not defend himself unrestrictedly in court, since his resources to do so were continually taken away. Even the standard literature on the Holocaust was confiscated.

Only those who have themselves undergone the same thing can judge the psychological stress caused to an innocent person through undergoing years-long criminal prosecutions. In addition to these psychic burdens, there are the legal expenses to consider. Currently, they can be calculated only with difficulty but, loosely estimated, they must run into a few hundred thousand dollars. It is clear that at the close of the trial against him, Rudolf was financially ruined for the foreseeable future – quite apart from the fact that for the foreseeable future he would be given no chance to meet these burdens through employment in his profession, at least not within Germany.

Fourth Step: Defamation

At the close of the labor court hearing of the case against the Max Planck Institute, the *Deutsche Presse-Agentur* (DPA) published its already mentioned false announcement on the Rudolf Report.

Rudolf not only proved that the expert opinion cited in this announcement by the DPA was wholly fabricated – the MPG distanced itself from the announcement – but also that the report based on the phantom opinion is so false that no expert in the world would embrace it. But this does not hinder the media from spreading the announcement far and wide and using it as proof of the obvious falseness of the Rudolf Report (see Part II., chapter 6). In the meantime, this false press release

even appeared in the media in foreign countries.⁶⁹² Since then, Rudolf has been defamed as a right-wing radical,⁶⁹³ a right-wing extremist,⁶⁹⁴ a Neo-Nazi⁶⁹⁵ and a brown doctoral candidate.⁶⁹⁶ His Report is always named in quotation-marks, and characterized as hack-work⁶⁹⁷ or merely as a “false report.”⁶⁹⁸ Unfounded accusations of xenophobia⁶⁹⁹ are accompanied by the false assertion of Judge Dr. Mayer that Rudolf was deeply marked by anti-Semitism, which, since it is wrong, is all the more ferociously maintained.

By 1994, Rudolf had had no success with his attempts to defend himself against the effects of hostile descriptions, but this was due more to financial difficulties than to judicial defeats.⁷⁰⁰ But once Rudolf was sentenced for his supposed crime, the media declared open season on him.

Fifth Step: Destruction of the Personal World

When the ARD smeared Rudolf in the most vicious way in its spring 1994 broadcast *Report*,⁷⁰¹ Rudolf’s parents distanced themselves from him and refused to come to his wedding, scheduled for several weeks later. All his relatives joined them in this, except for his siblings.⁷⁰² His godmother Hannelore Dörschler distanced herself expressly from the views of the people with whom Rudolf surrounded himself, without knowing with which persons Rudolf actually surrounded himself or what views they held.⁷⁰³

Since November 2, 1983, Rudolf had belonged to the Catholic German Student Fraternity AV Tuisconia Königsberg in Bonn. This fraternity is a member of an umbrella organization that claims to be the largest academic organization of Europe, and to which famous personalities

⁶⁹² For example, in the South African newspaper *The Citizen*, June 24, 1995, p. 8.

⁶⁹³ DPA news release on March 28, 1994, published in the German daily newspapers on March 29, 30, 31, 1994.

⁶⁹⁴ *Die Welt*, April 5, 1995.

⁶⁹⁵ *Landesschau*, Südwest 3, Dec. 27, 1994; *Kreiszeitung – Böblinger Bote*, March 29, 1995.

⁶⁹⁶ *Die Zeit*, April 15, 1993, p. 44.

⁶⁹⁷ *Stuttgarter Zeitung*, Nov. 23, 1994

⁶⁹⁸ *Die Welt*, March 29, 1994.

⁶⁹⁹ *Stuttgarter Zeitung*, Jan. 27, 1995

⁷⁰⁰ A complaint against the *Süddeutsche Zeitung* was denied on account of errors of form, but the fee of ca. DM 5,000 (ca. \$2,500) had to be paid anyway.

⁷⁰¹ A detailed critique of this broadcast can be found in: W. Schlesiger, *op. cit.* (note 615).

⁷⁰² Statement of witness Ursula Rudolf on March 24, 1995, District Court Stuttgart, ref. 17 KLs 83/94.

⁷⁰³ Letter of the defendant to his godmother on April 30, 1994, introduced in the main trial proceeding on Feb. 23, 1995 in Trial District Court Stuttgart, ref. 17 KLs 83/94.

belong(ed): Josef Cardinal Höffner, Joseph Cardinal Ratzinger, Friedrich Cardinal Wetter, Archbishop Johannes Dyba, Franz-Josef Strauß (former Ministerpresident of Bavaria, Federal Defense Minister), Philipp Jenninger (former President of the German Parliament), Matthias Wissmann (former Minister for Science and Technology), Alexander von Stahl (former federal general state attorney), Herbert Hupka, Rainer Barzel, Otto von Habsburg, Friedrich Wilhelm, Prince von Hohenzollern, Prof. Peter Berglar, Prof. Josef Stingl, Thomas Gottschalk and others.⁷⁰⁴

When Rudolf's revisionist activity became known in spring 1994, the umbrella organization exerted pressure on Rudolf's organization to expel him. Because of this, his organization convened a session of various of its members that spring, without the knowledge or participation of Rudolf, at which his revisionist activity was discussed. An expulsion process followed that held a hearing on August 20, 1994, and ended by expelling him in the fall.

This expulsion was by reason that:⁷⁰⁵

"The Holocaust and the acknowledgement thereof is the normative foundation of our [German] Constitution. The legitimacy – in the sense of worthiness of acceptance – of the Basic Law is based on the recognition of the fact of National Socialist criminal measures by which Jews were subject to a systematic technical mass murder. Inasmuch as Fraternity Brother Rudolf raises doubts about the deliberate annihilation of the Jews, he also raises doubts about the normative consensus on which the Basic Law is based.

Content (normative consensus) and form (institutional order) of the Basic Law are inextricably interwoven and their substance cannot be altered.

Thereby, Fraternity Brother Rudolf violates our Patria Principle."

The Patria Principle is one of the four principles of the semi-conservative umbrella organization.⁷⁰⁶ Today, the principle is primarily understood as meaning constitutional patriotism. It is left to the reader to judge the mental health of the lawyers that composed these pronouncements. The fact is that the decision to expel Rudolf because of the pressure from the superior organization was inescapable, and it was admitted that the decision would have been otherwise, had there been no outside pressure.⁷⁰⁷

⁷⁰⁴ Cartell-Verband der katholischen deutschen Studentenverbindungen (Cartel-Union of Catholic German Student Fraternities) (CV), with approximately 35,000 members.

⁷⁰⁵ Written decision of the Conduct Court, e. v. AV Tuisconia Königsberg zu Bonn on Aug. 20, 1995, written by constitutional attorney Herbert Stomper. Rudolf's appeal was rejected.

⁷⁰⁶ The other three are: religio, scientia, amicitia.

⁷⁰⁷ Testimony of union brother Dr. Markus Kiefer in the trial in the Conduct Court.

Sixth Step: Homelessness

When the police searched Rudolf's home a second time on August 18, 1994, the local media described him as a well-known right-wing extremist personality. In the small village of Jettingen, where Rudolf lived at the time, it was thought necessary to do something to rid the town of this unwelcome citizen. It was made clear to Rudolf's landlord that the community did not wish him to lease a dwelling to Rudolf. It was also made clear to the landlord that he should have an interest in getting rid of his lessee, too, since otherwise he would have to deal with such things as that his son could no longer bring his friends home, because their parents would not allow them to enter a house in which Neo-Nazis lived.⁷⁰⁸ Therefore, Rudolf's occupancy of the dwelling was terminated as soon as the lease allowed, at a time when his wife expected the birth of their first child within four weeks.⁷⁰⁹

When the landlords of the dwelling that Rudolf had rented thereafter, the couple Sedlatschek of Steinenbronn, learned from the news on June 23, 1995, about the fact that Rudolf had been sentenced to 14 months imprisonment, they had their lawyers communicate the following to him:⁷¹⁰

"In the name of and on behalf of our clients we hereby terminate immediately the lease under the lease contract executed October 26, 1994, between you and them.

Our clients became aware through the press, by radio, and television that you, Herr Rudolf, were sentenced to 14 months imprisonment by the District Court of Stuttgart for the crime of incitement to racial hatred. Our clients therefore no longer desire to continue the lease.

I am required to demand of you to depart from the dwelling no later than

July 31, 1995

and to surrender the premises to our clients in the agreed-upon condition.

If you fail to comply with this demand, we are authorized to file a complaint without delay."

When Rudolf requested his landlord to withdraw the termination, threatening otherwise he would file a counter-complaint, the landlord threatened eviction. For private reasons, among them that his wife was

⁷⁰⁸ So the statement of the landlord at the time, Karlheinz Bühler, to G. Rudolf in later Summer 1994.

⁷⁰⁹ It was not necessary to give a reason, because by the German Civil Code (BGB) no reason for termination is necessary with respect to a two-family house in which the landlord himself lives.

⁷¹⁰ Facsimile reproduction of this document in *Sleipnir* 4/95, insider back cover.

expecting her second child, he submitted, found a new residence and settled with his landlord out of court.

Seventh Step: Special Treatment

On May 5, 1995, the GRÜNE/Alternative Liste (a radical-left environmental splinter party) of the parliament of Hamburg demanded access to court records in the Rudolf case. Though denied at first, a subsequent request for records access on July 3, 1995, apparently succeeded,⁷¹¹ although it is not legal to grant access to the court records to outside persons who have no direct interest in a case. It is reasonable to fear that the records may have come into the hands of radical anti-fascist groups, where data on witnesses could be collected and compared.

The dot on the “i” was the request on October 16, 1994, of the Project for Study of Anti-Semitism, Faculty of Humanities of the University of Tel Aviv, in which a certain Sarah Rembiszewski requested information on the state of Rudolf’s prosecution.⁷¹² The judges also were aware of the world-wide attention on the case. Tel Aviv also pressed for records access. Was it possible to hope that records access would remain denied despite the ever more strident pleas out of Tel Aviv, inasmuch as the research institute has no legal claim to such access? Under current law, access to court records cannot normally be granted to outside persons with no interest in a case. If it should turn out that Tel Aviv got access to the records without legal ground, that therefore Jews in Germany still receive *Sonderbehandlung* (special treatment),⁷¹³ presumably a copy of the records will soon appear in the offices of a university that probably would like to have intimate details of the revisionist scene in Germany. It is even likely the records will find their way to other offices where a more active use might be made of them.

⁷¹¹ Sheet 1411 of the Records in Trial District Court Stuttgart, ref. 17 KLs 83/94, with the handwritten note by Dr. Mayer that access to the records should be granted after records had been returned by the defense.

⁷¹² Investigation File 2, Sheet 876, in trial of District Court Stuttgart, ref. 17 KLs 83/94.

⁷¹³ From the letter of the defense attorney Dr. G. Herzogenrath-Amelung to the District Court of Stuttgart on this subject on Nov. 16, 1995, in Trial District Court Stuttgart, ref. 17 KLs 83/94.

Eighth Step: Destruction of the Family

After his 14 months prison sentence was confirmed in March 1996 by the German Federal Supreme Court, and considering the prospect of perhaps even more severe convictions in several other pending criminal investigations, probably ending with a summary sentence of up to four years in prison, Rudolf decided to leave Germany with his family and to settle in England, where he thought freedom of speech was more than mere lip service. Having built up a revisionist publishing company abroad, his wife decided at the end of 1998 that she could not bear the life in exile, permanently fearing the extradition of her husband, being separated from all her old friends and relatives, having difficulties to find new friends and acquaintances, and thus heavily suffering from homesickness. Hence, in early 1999, she and their two children returned to Germany and later started the divorce procedure from her husband, leaving him alone in exile.

In fall 1999, when the British media started a smear campaign against Rudolf, his wife's nightmare came true: Rudolf became fair game of British politics, media and the justice system.⁷¹⁴ Before this witch hunt began, it had been possible for his wife and his children to visit Rudolf frequently. But ever since it has been extremely difficult, since Rudolf left Europe in late 1999 and entered the USA, where he applied for Political Asylum in October 2000. Especially the abandoned father and his two children suffered terribly under this situation of being almost totally isolated from each other.

In February 2000, Rudolf's father urged him to get sterilized, since it would be irresponsible both for his first family as well as in general – considering the conditions he had to live in – to father any more children.⁷¹⁵ Fortunately Rudolf did not heed his father...

Formerly, the persecution of the Jews by some Germans led to consideration to get certain Jews sterilized. Today, the persecution of Germans, mainly promoted by some Jewish lobbies, leads to considerations to get Germans sterilized.

In August 2000, a week before he was legally divorced from his wife, Germar Rudolf was told by his mother that his parents had disinherited him and entered his children in their last will instead.

⁷¹⁴ See part II, chapters 3 and 6.

⁷¹⁵ Email by Georg Hermann Rudolf from February 19, 2000.

Ninth Step: Loss of Freedom

Rudolf's asylum case dragged on for many years and was finally decided – rejected – in early 2006. In the meantime Rudolf had married a U.S. citizen, and at the beginning of 2005 he had become the proud father of a daughter. Due to their marriage the Rudolf couple had applied for an adjustment of his immigrant status with the U.S. authorities in late 2004, so that his status as a visitor who had applied for political asylum would be changed to that of a legal permanent resident.

Following conventional procedure, the Rudolf couple was asked to appear at the nearest office of the U.S. Immigration and Naturalization Services for an interview on Oct. 19, 2005, which is meant to verify that their marriage truly is a *bona fides* (real) one. Coming in with their baby in its stroller, it was a breeze for the Rudolf couple to get their marriage certified as genuine.⁷¹⁶

Yet right after the officer had handed them the certificate of recognition, two other officers declared that Rudolf was under arrest for allegedly having missed an interview appointment five months earlier – which had actually never existed to begin with.⁷¹⁷ Although Rudolf's lawyer tried to prevent his arrest, and although the local officer was inclined to heed this plea, an order came from Washington that very hour to arrest and prepare Rudolf for his deportation to Germany anyway. His recognized marriage to a U.S. citizen did not impress the U.S. officials at all. They simply claimed that no person who has entered the U.S. as a tourist “on parole” (which applied to Rudolf) has a right to even apply for adjustment of status, a claim which clearly contradicts statutory law, as was later confirmed.

Rudolf was subsequently shackled with hands and feet onto a long chain together with numerous criminals – like dangerous wild animals – and brought to the Kenosha County Jail (WI) awaiting his deportation. According to the wrist ID band he obtained in that prison, he was the only “non-criminal” inmate in the entire facility, which raised the eyebrows of both prisoners and guards.

⁷¹⁶ See <http://germarrudolf.com/persecute/docs/ApprovedMarriage.pdf>

⁷¹⁷ Rudolf was told during his arrest that this alleged appointment should have served to take his fingerprints and a passport-size portrait, although his fingerprints had already been taken back in 2001 and he had regularly sent in updated portraits every year during his asylum proceedings, the latest just in spring 2005. Later the U.S. government claimed that Rudolf was meant to present himself on April 7, 2005, for his deportation; see U.S. Immigrations and Customs Services, “ICE deports ‘Holocaust revisionist’ to Germany,” once at www.ice.gov/pi/nr/0511/051115chicago.htm, but now removed; cf. www.revisionisthistory.org/revisionist18.html.

The U.S. Federal Court in Atlanta dealing with Rudolf's asylum case – which was still pending then! – turned down Rudolf's request to have the deportation stayed until the Court had reached a decision.

The U.S. Supreme Court did not even bother to look at the case.⁷¹⁸

So the question is: what is an application for political asylum good for, if a government deports the asylum seeker *before* the court dealing with the case has decided whether the case has any merits?

And what is the value of the guarantee of due process – given to every person on U.S. soil by the Fifth Amendment to the U.S. Constitution – if the government can simply abort a pending legal review by deporting a defendant to a foreign dungeon? Or as Rudolf's lawyer put it:⁷¹⁹

“If all petitioners like Rudolf [...] seeking judicial review of agency decisions to issue orders of removal could simply be taken into custody and removed, the Government could avoid judicial review of agency decisions altogether. [...] Upon removal, Rudolf [was] separated from his U.S. citizen spouse and infant child and he [faced] continued persecution by the German government. [...] After removal, these injuries could not then be redressed by any favorable ruling from this Court. Rudolf's removal [...] violate[ed] his right to due process under the Fifth Amendment to the United States Constitution.”

On November 14, 2005, Rudolf was notified that he will be banned from returning to the U.S for five years for having overstayed his tourist parole time (90 days). Then he was deported to Germany, where German officials immediately arrested him at the airport and ferried him to the Rottenburg prison in southwest Germany, so that he may serve the outstanding 14 months prison sentence. A few days later Rudolf was transferred to the Stuttgart jail, as the German authorities had realized that there are more cases pending against Rudolf for his publishing activities during the previous nine years while residing in England and the U.S. Although Rudolf's publishing activities there were completely legal in those countries, the German authorities opine that they have to apply the German Penal Code on legal activities in foreign countries as soon as the “effects” of that crime are noticeable in Germany – that is: if the publication deemed illegal can be accessed in Germany via the Internet or if a hardcopy of it is imported to Germany.

When the Federal Court in Atlanta finally rendered a decision in the asylum case some three months *after* Rudolf's deportation, it stated

⁷¹⁸ For both court's rejections see <http://germarrudolf.com/persecute/docs/Denial.pdf>

⁷¹⁹ Motion to the U.S. Supreme Court to stay Rudolf's deportation, <http://germarrudolf.com/persecute/docs/USSEmergencyApplication.pdf>

simply that the U.S. government has a right to deport any asylum seeker it wishes. Rudolf's argument that his premature deportation was a crass violation of the right to due process as guaranteed by the Fifth Amendment to the U.S. Constitution was simply hushed up and ignored in the Court's decision.⁷²⁰ That's the way to render "justice" without creating untenable case law: simply sweep the core issues under the carpet and ignore all the evidence.

On the upside, however, the U.S. Federal Court in Atlanta declared as illegal the regulation which the U.S. Immigration and Naturalization Services had used to justify their refusal to adjudicate Rudolf's application for adjustment of status to that of a permanent legal resident (or in plain English: they didn't want to give Rudolf a so-called "Greencard," but now they have to...). In summer of 2006 the U.S. government changed this illegal regulation by allowing future applications for permanent residency filed by tourists to be adjudicated. But the new version specifically excludes from an adjudication all old applications filed by persons who have already been deported. All attempts to get legal redress against this regulation failed, because Rudolf has the opportunity to file a new application after his release from prison.

And that is exactly what Rudolf did after his release in July 2009. While his application for a so-called "green card" was pending, he spent a year in England, where his U.S. wife and daughter joined him for five months and where he could give his eldest daughter from his first marriage an opportunity to spend one school year abroad, to become fluent in English, and to get to know her own father.

In April 2010 the U.S. Consulate in Frankfurt indicated that the only thing barring them from issuing an immigrant visa to Rudolf is the still pending five year ban to return to the U.S. However, when this ban expired in November 2010, rather than issuing the visa, the consulate repeatedly postponed a decision and finally declared that it cannot foresee any resolution of Rudolf's case. Against this ongoing procrastination by the U.S. authorities Rudolf filed a Writ of Mandamus on January 31, 2011, in order to force the U.S. government to adjudicate his pending application.

⁷²⁰ See <http://germarrudolf.com/persecute/docs/11CircuitDecision.pdf>, p. 5.

8. Biographical Notes on the Author

Germar Rudolf, a certified chemist, was born on October 29, 1964, in Limburg/Lahn, Germany. Elite High School Diploma (*Gymnasium Abitur*) in 1983 in Remscheid, followed by study for a certified chemist's degree at the University of Bonn, graduation *summa cum laude* in September 1989. Completion of compulsory military service with the German *Luftwaffe* (Air Force). Between October 1990 and June 1993, Mr. Rudolf worked on the preparation of a doctoral thesis at the Max Planck Institute for Solid State Research in Stuttgart. Despite the highest recommendations, he was forced to withdraw his dissertation, because the University of Stuttgart threatened to reject it on political grounds (due to his involvement in revisionism).

Since early 1993, he has been the defendant in several criminal prosecutions resulting from the publication of scientific texts. One of the cases resulted in a 14 months prison sentence. Shortly after the appeal for this case had been rejected in March 1996, but before an arrest warrant had been issued for him, he decided to leave his native Germany and to go into exile, first England, then, in late 1999, the United States, where he applied for political asylum. In late 1996, Mr. Rudolf established the publishing house Castle Hill Publishers and, simultaneously, a quarterly historical periodical in the German language, with the aim of addressing critical aspects of contemporary history currently suppressed in all Ger-

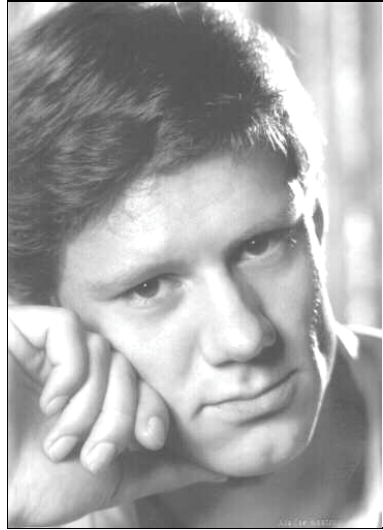

*The Author in summer 1991,
while doing the main work
for this expert report*



The author in late 2002

man speaking countries. In 2000, he started publishing English language books on revisionist topics under the imprint of Theses & Dissertations Press, a firm originally established by Robert H. Countess and purchased by Rudolf in summer 2002. Between 2003 and 2005, he also published a quarterly historical language of English language, which focuses on the same topics as his German periodical.

In late summer 2004 Rudolf married a U.S. citizen. Due to this he applied for permanent residence in the U.S. while his asylum case was still pending. As a result he and his



The author in April 2010

wife were asked to appear to an interview with the U.S. Immigration Services on October 19, 2005. Their marriage was subsequently certified as valid and genuine, but right after the couple had obtained their certificate, Rudolf was arrested and four weeks later deported to Germany, with the reason given that Rudolf, as a rejected asylum seeker, has no right to apply for permanent residence. In Germany he was arrested at the airport and incarcerated. In the years 2006/2007 he was tried for numerous items he had published while residing in the USA. Although perfectly legal there, Germany nevertheless applies German law to those cases, if such publications are accessible in Germany via the internet or are being imported to Germany. Rudolf was sentenced to an additional 30 months of imprisonment. Together with his old verdict of 14 months, he subsequently spent 44 months in various German prisons before being released on July 5, 2009.

Roughly one month after his release he left Germany for good – or so he hopes.

Appendices

Lists

1. List of Tables

	Page
Table 1: Arguments relating to the Zyklon B introduction columns	122
Table 2: Equipment and suitability of actual or alleged “gas chambers”	134
Table 3: Physical Properties of HCN	143
Table 4: Factors Influencing the Formation of Iron Blue	158
Table 5: Dissociation constants and solubility products of iron compounds	162
Table 6: Composition of Portland cement.....	171
Table 7: Absorption of hydrogen cyanide by various building materials	175
Table 8: Effect of various concentrations of hydrogen cyanide in air upon human beings	180
Table 9: Reduction of O ₂ content in air-tight Morgue 1 as a function of time	200
Table 10: Amount of hydrogen cyanide as a function of execution time	201
Table 11: Some values of the ventilation efficiency of a hypothetical homicidal “gas chamber,” with Zyklon B remaining in the chamber	211
Table 12: Some values of the ventilation efficiency of a hypothetical homicidal “gas chamber,” with Zyklon B removed from chamber	212
Table 13: Quasi-stationary concentrations of HCN in masonry in percent of saturation, as a function of daily exposure time to HCN.....	214
Table 14: Maximally admissible concentration of harmful compound for protection filters	215
Table 15: Minimum break through times for filters.....	216
Table 16: Evaluation of eyewitnesses	221
Table 17: Cyanide concentrations in the masonry of “gas chambers”/disinfestation chambers according to F.A. Leuchter	234

Table 18: Cyanide concentrations in the masonry of “gas chambers”/disinfestation chambers according to the Jan Sehn Institute for Forensic Research, 1990.....	235
Table 19: Cyanide concentrations in the masonry of “gas chambers”/disinfestation chambers according to the Jan Sehn Institute for Forensic Research, 1994.....	236
Table 20: Cyanide concentrations in the masonry of “gas chambers”/disinfestation chambers according to G. Rudolf....	239f.
Table 21: Analysis results from the Institut Fresenius and the Institut für Umweltanalytik	243
Table 22: Test sample preparation and fumigation	252
Table 23: Cyanide concentrations in the masonry of “gas chambers”/ disinfestation chambers according to J.C. Ball.....	254
Table 24: Orders of magnitude of analytical results of various samples.....	257
Table 25: Influence of CO ₂ on the Absorption of HCN According to Markiewicz et al.....	258
Table 26: Comparison between cases of building damage, morgue and disinfestation chamber.....	269

2. List of Illustrations

	Page
Figure 1: Schematic drawing of the U.S. execution gas chamber in North Carolina	11
Figure 2: How to get rid of termites	16
Figure 3: The Protestant church at Meeder-Wiesenfeld.....	20
Figure 4: Inky blue stains on the plaster of a church fumigated with hydrogen cyanide	21
Figure 5: Single door to an execution gas chamber for one single person per gassing procedure (Baltimore, USA)	24
Figure 6: Door of an alleged National Socialist gas chamber for the execution of hundreds of persons simultaneously (Crematorium I, Auschwitz).....	24
Figure 7: Frederick A. Leuchter	25
Figure 8: Prof. Dr. Robert Faurisson.....	29
Figure 9: Prof. Faurisson after an attack by Jewish thugs	36
Figure 10: Map of the surrounding vicinity of Auschwitz during the Second World War.....	51

Figure 11:	Map of Auschwitz I/Main Camp (concentration camp)	52
Figure 12:	Map of POW camp Auschwitz II/Birkenau.....	53
Figure 13:	Ad by the Degesch depicting its railway disinfection tunnels in Germany.....	56
Figure 14:	A lice-ridden train enters a railway gassing tunnel in Budapest.....	58
Figure 15:	Degesch delousing chamber with circulation feature	59
Figure 16:	Schematic organization of a hygiene complex.....	60
Figure 17:	Typical advertisement of the firm Degesch	61
Figure 18:	Ground plan of the HCN disinfection wing of building 5a before building alterations (mirror image) and BW 5b today.....	68
Figure 19:	Ground plan of the hot air disinfection wing of building 5a after building alterations in 1943	69
Figure 20:	Ventilation outlets from the disinfection wing of building BW 5b.....	70
Figure 21:	Water pipe system with shower heads in the disinfection wing of building BW 5b.....	72
Figure 22:	Ground plan of Crematorium I in Auschwitz I/main camp in its original planning condition.....	74
Figure 23:	Ground plan of Crematorium I Auschwitz I Main Camp after conversion to air raid shelter	75
Figure 24:	Ground plan of Crematorium I in Auschwitz I/Main Camp today	76
Figure 25f.:	Two of the four former openings through the roof of the morgue of Crematorium I in Auschwitz Main Camp	80
Figure 27:	Schematic plan of the morgue of Crematorium I with position of holes in the ceiling.....	81
Figure 28:	Ground plan of Morgue 1 (alleged “gas chamber”) of Crematoria II and III (mirror symmetrical) in Auschwitz II/Birkenau	86
Figure 29:	Cross-section of Morgue 1 (alleged “gas chamber”) of Crematoria II and III (mirror symmetrical) in Auschwitz II/Birkenau	86
Figure 30:	Schematic location of the new crematorium as originally planned for the Auschwitz main camp.....	89
Figure 31:	Schematic location of Crematorium II, altered plan for Birkenau	89

Figure 32:	Wooden disinfestation chamber door at Auschwitz.....	94
Figure 33:	German air-raid shelter door.....	95
Figure 34:	Photograph of two indicator devices from the Siemens; component of a gas tester	102
Figure 35:	Photograph of Crematorium II of Birkenau taken in February 1943	103
Figure 36:	Magnification of detail from Fig. 35 with outlines of the morgue and scale of measurements drawn in	104
Figure 37:	Schematic drawing of a view onto Morgue 1 of Crematorium II.....	105
Figure 38:	Photograph of Crematorium II from Jan. 20, 1943.....	105
Figure 39:	Enlargement of Allied air photo RG 373 Can F 5367, exp. 3185 of Birkenau camp, taken on August 25, 1944	106
Figure 40:	Schematic drawing of the air photo in Fig. 39.....	107
Figure 41:	Schematic drawing of the location and size of the spots on the roof of Morgue 1 (the “gas chamber”) of Crematorium II	108
Figure 42:	Interior photograph taken from the ruins of Morgue 1 (“gas chamber”) of Crematorium II.....	109
Figure 43:	Alleged Zyklon B introduction hole in the ceiling of Morgue 1 (“gas chamber”) of Crematorium II, entry to the still passable part of the cellar.....	110
Figure 44:	Ceiling of Morgue 1 (“gas chamber”) of Crematorium II.....	111
Figure 45:	Alleged Zyklon B introduction hole in the roof of Morgue 1 (“gas chamber”) of Crematorium II in December 1991.....	112
Figure 46:	Hoop iron with dovetail, cast in cement in a hole in concrete.....	113
Figure 47:	Notch (fatigue) effect resulting at inserted openings from the application of force.....	114
Figs. 48-53:	The five properly constructed ventilation holes in the ceiling of the oven room to the upper story, Crematorium III	116
Figure 54:	J.-C. Pressac’s drawing of the legendary “Zyklon B introduction columns”.....	119
Figure 55:	Handwritten entries in an inventory list of Crematorium II for Morgue 2.....	120

Figure 56:	North view and ground plan of Crematorium IV and/or V (mirror image) in Auschwitz II/Birkenau	125
Figure 57:	Then and today – the unchanged ground water state in the Birkenau camp, here in midsummer 1991	130
Figure 58:	White circles: possible sites of old mass graves of typhus victims in Auschwitz.....	132
Figure 59:	Interior room in the Zyklon B disinfestation wing of BW 5a in the Birkenau camp	color section, 140
Figure 60:	Exterior wall of the Zyklon B disinfestation wing of BW 5b in the Birkenau camp	color section, 140
Figure 61:	Zyklon B disinfestation installation, chamber III of barrack 41 in Majdanek camp	color section, 141
Figure 62:	Zyklon B disinfestation installation, east wall of chamber III, barrack 41, Majdanek.....	color section, 141
Figure 63:	Large Zyklon B disinfestation chamber, ceiling, barrack 41 in Majdanek camp	color section, 141
Figure 64:	Zyklon B disinfestation installation, exterior wall of barrack 41 in Majdanek camp	color section, 141
Figure 65:	Zyklon B disinfestation chamber in Stutthof camp, interior.....	color section, 142
Figure 66:	Zyklon B disinfestation chamber in Stutthof camp, east side, exterior	color section, 142
Figure 67:	Sketch of Morgue 1 (“gas chamber”) of Crematorium II in Birkenau with test sample taking locations by F.A. Leuchter	233
Figure 68:	The outside of the external wall of hydrogen cyanide delousing wing of building 5a in Aug. 1991.....	245
Figure 69:	Interior room in the Zyklon B disinfestation wing of BW 5a in the Birkenau camp (same as Fig. 59).....	246
Figure 70:	Picture of the door frame in disinfestation wing of building 5a	247
Figure 71:	Exterior wall of the Zyklon B disinfestation wing of BW 5b in the Birkenau camp (same as Fig. 60)	248
Figure 72:	Construction drawing of the experimental container for the fumigation of material samples with hydrogen cyanide	251
Unnumbered:		
	Letter by Michel Adam, Nov. 2, 1997.....	225
	Results of analyses by Institut Fresenius.....	241f.

Portrait Otto Ernst Remer	376
Building of Institut Fresenius	377
Portrait Viktor Robert Knirsch	379
Portrait Hajo Herrmann	385
Letter Moritz Rotberg, Holon, Israel	387
Portrait Dr. Herbert Schaller	388
Portraits Gernar Rudolf	437f.

3. List of Graphs

	Page
Graph 1: Vapor pressure of hydrogen cyanide in percentage of air pressure as a function of temperature	144
Graph 2: Saturation concentration of hydrogen cyanide in water as a function of temperature at 1 mol% HCN in the air ...	152
Graph 3: Degree of coverage of the surface of a solid material with an adsorbed gas as a function of temperature	154
Graph 4: Degree of disassociation of hydrogen cyanide as a function of the pH value at room temperature	155
Graph 5: Cyanide equilibrium concentration in water as a function of the temperature and pH value	156
Graph 6: Free Fe^{3+} concentration as a function of pH value and the resulting minimal pK_S value of Iron Blue	163
Graph 7: Accumulated pore volume distribution of concrete and of wall mortar	172
Graph 8: Drop in the hydrogen cyanide concentration in old, dry, cement blocks, after 24-hour fumigation	177
Graph 9: Evaporation rate of hydrogen cyanide from the Ercco carrier material	183
Graph 10: Schematic representation of the breathing volume behavior relative to time in case of suffocation/poisoning ..	198
Graph 11: Incorporated amount of HCN as function of time until respiratory arrest	199
Graph 12: Hydrogen cyanide concentration behavior in delousing chamber with and without circulating air systems	202
Graph 13: Hydrogen cyanide concentration behavior in disinfestation chamber with and without clothes	202
Graph 14: Relation between hydrogen cyanide adsorption on clothing and temperature in a delousing chamber	203

Graph 15: Simulation of the concentration of hydrogen cyanide
in a hypothetical homicidal “gas chamber” 209

4. List of Abbreviations

APMO	Archiwum Panstwowego Muzeum w Oswiecimiu
DIN	Deutsches Institut für Normung
DPA	Deutsche Presse-Agentur
IMT	International Military Tribunal/Internationaler Militärgerichtshof
JHR	The Journal of Historical Review
MPI	Max-Planck-Institut für Festkörperforschung, Stuttgart
RVGA	Rossiiskii Gosudarstvennii Vojennii Archiv (Russian national war archives)
VffG	Vierteljahreshefte für freie Geschichtsforschung

Index

Names, locations, topics. Topics covered by certain chapters are not included. References to chapters refer to Part I, unless noted otherwise.

- A —
 absorption: 139
 Academy of Sciences,
 French: 34
 Adam, Michel: 223
 Adler, Hans G.: 194
 Administrative Court,
 Baden-Württemberg: 424
 adsorption: 139
 Afghanistan: 285
 air raid shelter: 75-83, 90,
 95f., 233
 Alich, M.A.: 147, 159
 Allègre, Claude: 223
 Allgemeine Jüdische
 Wochezeitung: 382, 391
 Alpha Analytic
 Laboratories: 231-234,
 259
 Amnesty International: 12
 Andres, Bernhard: 292
 ANEC: 223
 ARD
 Panorama: 405, 425
 Report: 399, 403-406,
 428
 Tagesthemen: 404
 ARED GmbH: 280
 Armontrout, Bill: 14, 25
 Arosen: 385
 Ashland, MA: 231, 234,
 259
 Asia Minor: 54
 Auerbach, Hellmuth: 32,
 110
 Auschwitz: *passim*.
 Auschwitz State Museum:
 33, 45, 48, 52f., 87, 110,
 115, 118, 124, 140, 230,
 380
 Auschwitz Trial
 Frankfurt: 44f., 128, 304,
 370, 377, 382-386
 Krakow: 42
 Vienna: 45, 82
 Australia: 31, 357
 Austria: 31f., 45, 286, 306,
 357, 379, 400
 Austro-Hungarian
 Monarchy: 48, 73
 Avlijas, M.: 147
 Aynat, Enrique: 194
 — B —
 Backes, Uwe: 32
 Bacques, James: 226
 Bad Kissingen, Germany:
 303, 361, 376
 Baer, Richard: 128
 Bahners, Patrick: 312f.
 Bailar, J.C.: 147, 152
 Bailer, Josef: 32f., 196, 198,
 233, 237, 254f.
 Bailer-Galanda, Brigitte:
 32f., 77, 233
 Baker, Geraldine M.: 228
 Balkan: 54
 Ball, John C.: 108, 129,
 133, 189, 254
 Ball, John Clive: 108, 133,
 231, 253f., 257, 279
 Baltimore: 24
 Balzani, V.: 147, 165
 Barbezat, S.: 167
 Barford, engineer: 118
 Bartholomew, C.H.: 147
 Barzel, Rainer: 429
 Bastian, Till: 362
 Bauer, Yehuda: 373
 Baumann, prosecutor: 379,
 382, 387, 420
 Bautzen: 389
 Bavarian Ministry of the
 Interior: 168
 Bayern 1 radio: 379
 Beakes, H.: 159
 Beck, R.: 159
 Belgium: 31
 Bendel, C.P.: 194
 Bendel, Charles S.: 104,
 189, 191
 Benroubi, Maurice: 128
 Benz, Wolfgang: 33, 187
 Berenbaum, Michael: 98,
 141
 Berg, Friedrich Paul: 117,
 227, 279
 Berglar, Peter: 429
 Berlin: 61f., 126, 291f., 295,
 345, 389
 Olympics: 67
 Wall: 293
 Berlin Blue: 145, 237
 Bernfus, Erich: 57
 Berry, Jessica: 413
 Besnard, Marie: 40
 BET: 169
 Bethune, John E.D: 264
 Bezwinska, Jadwiga: 187
 Bhattacharya, A.K.: 146
 Bielefeld: 420
 Birett, Karl: 58
 Birkenau: *passim*.
 family camp: 53
 gypsy camp: 53
 Hungarian camp: 53
 pond: 131
 Birn, Ruth Bettina: 48
 Bischoff, Karl: 91f., 100
 Blobel, Paul: 186
 blue cloud in 'gas chamber':
 189f., 221
 Blüm, Norbert: 293
 Bobrach, Heinz: 61
 Bock, Ludwig: 356
 Böck, Richard: 128, 185,
 189f., 194, 377, 384
 Boehlke, Hans-Kurt.: 82
 Boisdefeu, Jean-Marie: 105
 Bolletta, F.: 147
 bones: 45, 133
 Börnstein: 152, 169
 Boston, MA: 23, 230
 Bradley, Timothy J.: 179
 Braker, William: 143
 Brauner, Aze: 372
 Breymesser, Hermann: 57
 British National Party: 413f.

- Broad, Pery S.: 73, 79, 128, 194, 370
 Broszat, Martin: 44, 128, 185, 187
 Brugioni, Dino A.: 106, 117
 Brunauer: 169
 Bubis, Ignatz: 409, 421-423
 Buchenwald: 29
 Buchheim, Hans: 44, 304
 Buchy, France: 19
 Bühler, Karlheinz: 430
 Buki, Milton: 128, 272
 Bulgaria: 187
 Bünde, north Germany: 419
 Bundesarchiv-Militärarchiv: 280
 Bundeskriminalamt: 335
 Bundesprüfstelle für jugendgefährdende Schriften: 281, 393, 395f.
 Bundeswehr: 294, 392
 Busser, H.J.: 145f., 151, 159
 Buszko, Jozef: 194, 196
 Butz, Arthur R.: 29f., 90, 265
- C —
 Canada: 23, 31, 108, 357
 Canada I: 62
 Cantagalli, Alberto: 102
 capillary condensation: 144
 Capital: 419
 Carassiti, V.: 165
 carbon dioxide: 81, 102, 152, 155-158, 170-173, 226, 236f., 257f., 269-273
 carbon monoxide: 19, 226, 228
 Carey, J.: 165
 Cartell-Verband der katholischen deutschen Studentenverbindungen: 429
 CDU: 285, 292-294, 411
 Charbonnages de France: 223
 chemisorption: 139
 Chen, N.G.: 160
 Christensen, J.J.: 147
 Christianson, Scott: 12
 Christmann, Carl Hermann: 21, 112, 261, 279
- Church of the Holy Juraj, Croatia: 16
 CIA: 108
 Cincinnati: 317, 347f.
 city gas: 167, 226f.
 civil rights: 313, 320, 323, 405, 413, 419
 Clair, Bertrand: 34
 coke gas: 226
 Cole, David: 80
 Colombe, Lodovico delle: 264
 common knowledge: 188, 356, 371f., 379-389, 426
 Conan, Eric: 77
 concentration: 143
 Countess, Elda: 280
 Countess, Robert H.: 34, 280, 438
 County Court
 Berlin Tiergarten: 281, 394
 Böblingen: 281, 394f.
 Mannheim: 281
 Munich: 281, 363, 394, 396
 Stuttgart: 424
 Tübingen: 281, 311f., 391, 396, 405
 Weinheim: 281, 395
 Court Toronto: 25
 crematoria II/III: chapter 5.3.1., and passim.
 crematoria IV/V: chapter 5.3.2., and passim.
 crematorium I: chapter 5.2., and passim.
 Croatia: 15
 Crowell, Samuel: 34, 90, 96f.
 Crowlink: 317, 328, 330
 CSU: 285, 289, 411
 Czech, Danuta: 47, 63, 104, 106
 Czechoslovakia: 286f., 354
 Czernin, W.: 170, 172
 Czurda, K.: 167
- D —
 Dachau: 59, 60, 140, 371f., 381, 386f.
 Damon, James M.: 280
 Daunderer, Max: 180, 182
- Deckert, Günter: 32, 312, 331, 355, 392, 426
 Deckert, Walter: 175
 Degesch: 24, 56-61, 68, 182f., 202, 229
 Kreislaufverfahren: 58-60, 65f., 98, 121, 125, 140, 201-203
 Degussa AG: 159, 197, 280, 404
 Dejaco, Walter: 45, 83, 88
 Delta, B.C.: 231
 Demjanjuk, John: 372
 Der Spiegel: 136, 375
 Desjardin, Daniel D.: 74, 196f.
 Detia Freyberg GmbH: 280
 Detscher: 363
 Deutsche Ausrüstungs-Werke: 62, 100
 Deutsche Presseagentur: 16, 168, 259, 399-406, 410-416, 427
 Deutschland Report: 400, 426
 Die Rheinpfalz: 415
 Diesel engine exhaust: 226f.
 dispersion: 146
 dissociation: 148
 District and Chamber Court of Berlin: 381
 District Court
 Bielefeld: 363
 Hamburg: 356
 Mannheim: 426
 Munich: 363
 Schweinfurt: 358f., 376, 379
 Stuttgart: 281, 294, 303, 311, 357, 364, 369f., 373, 400, 405-409, 416, 426f., 430
 Diwald, Hellmut: 280
 Dokovic, G.: 147
 Dominguez, Scott: 18
 doors, gas-tight: 24, 58, 76, 93-96, 125, 249
 Dora-Mittelbau: 29
 Dötzer, Walter: 57
 Dragan, Mirosław: 128
 Dragan, Myrosław: 132, 279
 Dragon, Szlama: 128

- Drahtnetzeinschiebevorrichtungen = wire mesh push-in devices: 104, 119
 Dreßen, Willy: 190
 Duda, W.H.: 170f.
 Duffy, C.T.: 12
 Dugoni, Robert: 18
 Duncan, J.F.: 145
 DuPont: 180
 Dwork, Deborah: 47, 78, 100
 Dyba, Archbishop Johannes: 429
 dynamite: 145
 — E —
 East Prussia: 258, 286
 Eastbourne: 327, 338f., 343f.
 Ebeling, Dieter: 402f.
 Ehrenburg, Ilya: 373
 Eichmann, Adolf: 29, 227
 Einsatzgruppe: 186
 Einsatzgruppen: 40
 Elias, Allan: 18
 El-Sayed, H.A.: 168
 Emmerling, E.: 20
 Emmet: 169
 Engelhard, Hans. A: 287, 380
 England: 413-415, 432, 437, see also Part II, chapter 3.
 Epstein, Joseph: 231
 Erber, Josef: 184
 Ercco, Zyklon B: 182f.
 Ertl, Fritz: 45, 83
 Evans, Sheila: 414
 Evergreen Resources: 18
 Ewing, G.J.: 159
 experimental gas chamber: 250f.
 — F —
 Fabius-Gayssot, law: 31
 Faith, Linda M.: 280
 farmhouses: 1, 50, 125-131, 134, 189, 193, 212, 217, 219, 275, 278
 Faßbender, R.: 112, 279
 fat, human
 for cremation: 186, 188, 221f.
 for soap: 372
 Faurisson, Robert: 13, 23-26, 29f., 36, 41, 46f., 77f., 82, 95, 117, 122f., 137, 191f., 279, 361, 364
 FDP: 293-295
 Federal Constitutional Court, German: 313-315, 401
 Federal Supreme Court, German: 311, 356, 358, 365, 369, 401, 412, 426
 Ferch, H.: 146, 159f., 164, 167
 Fick's law of diffusion: 213
 Filbinger, Hans: 296
 Filching: 317
 Finkelstein, Norman G.: 48
 Fischer, Joschka: 312
 Fischer, Konrad: 20, 268, 279
 flames
 cremation pits: 133, 189, 219, 275
 crematorium chimney: 188, 222
 Fleckfieber: 54
 Fleißner, Herbert: 305
 Florence, AZ: 12
 Fluck, E.: 145
 Flury, Ferdinand: 180
 Foerst, Wilhelm: 145, 164
 Forschungs- und Materialprüfungsanstalt, Stuttgart: 172, 280
 Forschungsinstitut für Pigmente und Lacke e.V.: 280
 Förster, Gerhard: 279
 Forth, Wolfgang: 180
 France: 223
 Franciszek Piper: 74, 124, 380
 Franke-Gricksch, Alfred: 194
 Frankfurt, Germany: 290, 294, 388
 free speech: see freedom, of expression
 freedom
 of expression: 223, 312, 325, 333, 336, 432
 of science: 312, 314, 375
 freedom of assembly: 292
 Freiburg, Germany: 280, 392
 Freitag, Bettina: 12
 Friedländer, Henry: 186, 191
 Friedmann, Bernhard: 293
 Friedrich Wilhelm, Prince von Hohenzollern: 429
 Frisch, Max: 403
 Friston: 317
 Fuchs, H.H.: 44
 Fuetterer, Andrew: 280
 — G —
 Galilei, Galileo: 264
 Garbarz, Moshe Maurice: 128
 Gärtner, Michael: 45, 87, 131f., 226, 279
 gas chamber: passim.
 Gaskeller: 90f.
 Gassing Cellar: 90
 Gaßner, Ludwig: 56, 59
 Gauss, Ernst: 33, 256, 391, 395-397, 400, 404, 408, (=Germar Rudolf)
 Geißler, Heiner: 293
 Genscher, Hans-Dietrich: 287, 379
 German Democratic Republic: 389
 Germany: 31
 Gerner, Manfred: 226
 Ghosh, S.N.: 146
 Gilbert, Martin: 96
 Ginsburg, Josef: 29
 Glazman, Y.M.: 146
 Gloxhuber, Christian: 180
 Glücks, Richard: 100
 Glushkova, M.A.: 161
 Göbel, Klaus: 280
 Goldhagen, Daniel: 48
 Goll, Ulrich: 314
 Gosh, B.N.: 146
 Gottschalk, Thomas: 429
 Grabert Verlag: 314
 Grabert, Wigbert: 315, 391, 393
 Grabitz, Helge: 373
 Grabner, Maximilian: 74
 Graf, Jürgen: 128, 136, 141f., 185, 187, 397
 Grande-Sagel, Irene: 44

- Gratzfeld, E.: 167
 Gray, judge: 34, 88, 90, 93, 97, 99, 259
 Great Britain: see England
 Green, Richard J.: 34f., 93, 135, 196, 258, 262-267
 Greimer, Karl: 56
 Grieb, Conrad: 12
 Griffin, Nick: 414
 Gross, Johannes: 419
 Grosser, D.: 21
 Grubach, Paul: 32, 35
 GRÜNE: 293, 431
 Guarantee Fumigation Company: 14
 Gubala, Wojciech: 33, 257, 394
 Gudehus, G.: 167
 Guillaume, Pierre: 34, 47
 Gurol, M.D.: 165
 Gutman, Yisrael: 98
- H —
 Haag, Friedrich E.: 57
 Häberle, Wolfgang: 32
 Hackett, David E.: 194
 Hagen, W.: 55
 Haggard, Howard W.: 199
 Hähnle, O.: 169
 hair: 41-45, 260
 hair clasps: 42
 hair cut: 49, 59, 193
 Haldane, John S.: 199
 Haller, E.: 379
 Hamburg: 402, 431
 Hamburger Institut für Sozialforschung: 194
 Hancock, Corrine: 316, 321-330, 333
 Hancock, Tony: 316, 319-329, 333-340, 343
 Hansa Luftbild: 384
 Hastings, Chris: 317-323, 350, 413-415
 Hastings, East Sussex: 316, 325, 338, 349, 351, 413-416
 hatches, gas-tight: 124
 Haverbeck, Werner Georg: 280, 363
 Haworth, D.T.: 147
 Hayward, Joel P.: 77
 Hecht, Otto: 57
 Heepke, Wilhelm: 98
 Heepke, Wilhem: 98
 Henderson, Yandell: 199
 Henschler, Dieter: 180
 Hepp, Robert: 280
 Herrmann, E.: 167
 Herrmann, Hajo: 181, 280, 301, 358-361, 376, 381-388, 409
 Herzogenrath-Amelung, Günther: 280, 355, 362, 431
 Hetz, Stefan K.: 179
 Hikime, S.: 147
 Hilberg, Raul: 382, 397
 Hilldorfer, Joseph: 18
 Hinsley, Francis H.: 383
 Hitler, Adolf: 30, 36, 256, 265, 288-292, 300, 303, 383, 424
 Hoerbst, Günther: 416
 Höfer, Werner: 296
 Hoffmann, Joachim: 280, 373, 392
 Höffner, Josef Cardinal: 429
 Hofmann, K.A.: 146
 Hölbing, K.: 194
 Holleman, A.F.: 146
 Holmes, Sherlock: 96
 Holocaust History Project: 267
 Holocaust Survivors and Friends in Pursuit of Justice: 26
 Holon, Israel: 387
 Honsik, Gerd: 194, 363, 379
 Höß, Rudolf: 71, 73, 79, 89, 119, 128, 185-188, 191, 194, 370, 386
 human rights: see civil rights
 Humphrey, Michael: 280
 Hunseder, Franziska: 404-406, 425
 Hungarian Jews: 128
 Hungary: 31, 187
 Hupka, Herbert: 429
 Huta: 88f.
 Hydrokop: 45
 Hygieneinstitut der Waffen-SS: 61
- I —
 I.G. Farbenindustrie AG: 49, 51, 141, 227f.
 Iceland: 352
 Igounet, Valérie: 191
 Institut Fresenius: 231f., 238-240, 243, 280, 307, 377, 380, 384, 399, 404, 423
 Institut für Umweltanalytik: 280
 Institut für Zeitgeschichte: 32, 44, 110, 301, 304
 Institute for Historical Review: 25, 366
 InterNic: 319
 IRA: 342
 Irmscher, Richard: 182-185, 209f.
 Iron Blue: passim
 Irving, David: 34, 88, 93, 97, 99, 118, 259f., 317, 321-323, 343, 347, 350, 363, 416
 Israel: 371f., 385, 387, 391
 Izatt, R.M.: 147
- J —
 Jäckel, Eberhard: 30
 Jacobsen, Hans-Adolf: 44
 Jagschitz, Gerhard: 194
 Jährling, Rudolf: 66, 103
 Jail fever: 54
 Jakobovits, Immanuel: 389
 Jan Sehn Institute, Krakow: 33, 42f., 46, 230f., 235-237, 256f., 263, 266, 380, 426
 Jefferson City: 14, 25
 Jenninger, Philipp: 296, 429
 Jerusalem: 372f.
 Jesse, Eckhard: 32
 Jettingen: 413, 430
 Jevington: 317, 337
 Johnson, M.F.: 147
 Jordan, Claus: 226
 Jordan, J.: 159
 Junge Union: 293
 Jungen Freiheit: 297, 300
 Jury Court, Frankfurt: see

- K —
- Kahlenbergendorf, Austria: 379
- Kalthoff, Jürgen: 56
- Kammerer, Rüdiger: 394f., 400
- Kammler, Hans: 65
- Kape, J.M.: 166
- Karl, Otto: 279
- Karlsruhe: 95
- Katyn: 41f., 381
- Kawahara, H.: 165
- Kelkheim, Germany: 169, 280
- Kelleher, C.L.: 40
- Kelleher, Michael D.: 40
- Kerler, W.: 145
- Khan, Genghis: 36
- Kiefer, Markus: 429
- Kirk, R.E.: 146, 159
- Kirschnek, Hans: 100
- Klarsfeld, Beate: 26
- Klarsfeld, Serge: 205
- Klee, Ernst: 190
- Klieve, Heinrich: 57
- Knirsch, Viktor Robert: 379
- Knödler, Heinz: 280
- Kogon, Eugen: 31, 104, 190, 194, 205, 300, 382
- Kohl, Helmut: 293
- Köhler, Manfred: 395
- Kohn, M.: 164
- Konieczny, J.: 128
- Königsberg, East Prussia: 286
- Konrad, Christian: 362
- Konrich, Friedrich: 55
- Körber, Hermann: 419-421
- Kosovo: 40
- Krakow, Poland: 33, 46
- Krakowski, Shmuel: 373
- Krausnick, Helmut: 44
- Kremer, Johann Paul: 128
- Kretschmer, Werner: 362
- Krleza, F.: 147, 161, 163
- Krueger, Bill: 11
- Kruse, Heinrich: 57
- Küchler: 164
- Kuenning, William H.: 160
- Kühn, Robert: 58
- Kula, Michal: 104, 119-122, 135, 180, 184
- Kulaszka, Barbara: 23, 25, 106, 261
- Kunike, Georg: 103
- Kunio, M.: 165
- L —
- Labeledz, Jerzy: 33, 257, 394
- Labor Court Stuttgart: 403
- Lachout, Emil: 279
- LaGrand, Walter: 12
- Lambrecht, Wolfgang: 183, 278
- Lamker, Hans: 67, 98
- lampshades made of human skin: 372
- Landolt: 152, 169
- Langbein, Hermann: 31, 194, 272, 383
- Langmuir: 153
- Lapp, C.: 164
- Latenser, Hans: 44
- Laugel, P.: 164
- Lawson, David: 11
- LD₁₀₀: 181
- Le Monde: 30, 382
- Leipprand, Horst: 279
- Lenski, Robert: 23, 106
- Lettich, André: 128, 194, 205
- Leuchter Report: 26, 29-35, 267, 297-300, 380
- Leuchter, Fred A.: 13f., 23-26, 33f., 46f., 77, 85, 130, 137, 141, 181f., 230-235, 238, 243f., 257-261, 267, 276, 300, 331, 355, 363, 380, 405, 421
- Lewenthal, Salmen: 194
- Lewis, Peter A.: 146
- ligand: 151
- Lill, K.: 194
- Limburg, Germany: 437
- Lingens-Reiner, Ella: 194
- Lipstadt, Deborah E.: 34, 88, 93, 97, 99, 118, 259, 416
- Lober, Jochen: 419
- London: 166, 322, 325, 330f., 338, 340f., 344f., 351, 394f., 413
- Los Angeles: 14
- Lovran, Croatia: 15
- Lübeck, Germany: 403
- Lublin: see Majdanek
- Ludi, A.: 145
- Lüfl, Walter: 20, 45, 83, 101, 279
- Luftwaffe: 301, 437
- Lummert, Horst: 409
- M —
- Maier, D.: 167
- Maier, Sonnhild: 408
- Majdanek: 23, 25, 92, 141, 260, 331, 381, 396
- Markiewicz, Jan: 33, 230f., 236f., 256-259, 263-267, 279, 394
- Marques, A.S.: 262
- Marshall, B.J.: 146
- Matsumoto, K.: 147
- Mattogno, Carlo: 33-35, 46-48, 74, 81, 87f., 91, 94-103, 114f., 118f., 126-132, 136, 141f., 168, 185-189, 192f., 229f., 279, 362, 394, 397
- Max Planck Institute for Solid State Research, Stuttgart: 39, 46, 281, 308f., 390, 399, 401, 408, 422f., 427, 437
- Max Planck Society, Munich: 400-402, 421-423, 427
- Mayer, Arno J.: 383
- Mayer, Dietmar: 425, 428, 431
- McCarthy, Jamie: 34, 119, 135, 263, 267
- Meinecke, Albert: 168, 259, 401f.
- Mexico: 54, 352
- Meyer, Fritjof: 136, 192, 375
- Militärgeschichtliche Forschungsamt: 392
- Mills, E.C.: 166
- Ministry of Justice, Baden-Württemberg: 313
- Moeschlin, Sven: 15
- Moggi, L.: 147, 165
- Mohler, Armin: 296f.
- mol: 151
- Molau, Andreas: 299
- Monowitz: 49, 227f.

- Montérolier: 19
 moon: 262-265
 Morgen, Konrad: 228
 Morris, Errol: 13, 85
 Mösbauer, Rudolf: 145
 Moscow: 48, 87, 385
 Mossman, Allen L.: 143
 Mrugowsky, Joachim: 57
 Müller, Filip: 104, 194
 Müller, G.-O.: 159, 164
 Müller-Focken, L.: 165
 Münch, Hans: 194, 205
 Munich: 44, 377, 396
 Murphy, Kim: 416

 — N —
 Nantes: 223
 National Front: 413f.
 Naumann, Bernd: 194
 Naumann, K.: 15
 Neuber, Heinz: 115
 Neufert, Ernst: 82, 99, 124
 Neugebauer, Wolfgang: 33
 Neumaier, Arnulf: 187f.,
 279, 372
 Neuwirth, W.: 145
 Niyzli, Miklos: 189, 191
 Nolte, Ernst: 44, 280
 northern Africa: 54
 Nowak, Hans Jürgen: 54,
 67, 94f., 226, 396
 NPD: 290f., 355
 nucleophilic: 148
 Nuremberg: 419
 Nuremberg Tribunal: 40,
 197, 380-382, 386-390
 Nyzizli, Miklos: 96, 194

 — O —
 ÖDP: 294
 Orlet, Rainer: 355, 392
 Othmer, D.F.: 146, 159
 Oudar, J.: 153
 Oxford: 323
 Ozeki, T.: 147

 — P —
 Paisikovic, Dov: 194
 Paris: 30
 partial pressure: 152
 Payer, judge Dr.: 394
 Pechiney-Ugine-Kuhlmann:
 223
 Perry, J.H.: 186
 persecution
 communist: 287
 Jewish paranoia: 351
 of dissidents: 46, 223,
 266, 299, 316, 320-323,
 352, 374, 375, 413, 425,
 432
 of Jews: 287-291, 298,
 313, 432
 Peter, W.: 145
 Peters, Gerhard: 57, 64, 98
 Petzet, Michael: 20
 Pfeiffer: 128
 Pfeiffer, Thomas: 415
 pH: 149
 Philipp, Karl: 140, 279, 303,
 361-363, 401, 409
 phosgene: 226
 photolysis: 165
 physisorption: 139
 Pilsen: 287
 Piper, Franciszek.: 74, 81,
 136, 197
 pK_s: 161
 Pocatello, ID: 18
 Poirier, Roger G.: 106, 117
 Poland: 23, 31, 33, 42, 48f.,
 73, 227, 231, 258f., 286f.
 Poliakov, Léon: 194, 196
 Political Asylum: 432
 Pomerania: 258
 Popper, Karl R.: 264, 315
 Porter, Carlos: 280
 Porter, Carlos W.: 43
 Post, Walter: 280
 Prague, Czechia: 48
 Pressac, Jean-Claude: 31-
 35, 46-48, 62f., 70-77, 85-
 101, 104, 106, 110, 113,
 115, 119-130, 180, 187-
 198, 211, 217, 219, 230,
 234f., 238, 270, 272, 275,
 370, 374
 Priestley, J.G.: 199
 process gas: 226-228
 producer gas: 226f.
 protolysis: 154
 Provan, Charles D.: 118,
 279
 Prowazek, scientist: 54
 Prüfer, Kurt: 91
 Prussian Blue: 19, 166, =
 Iron Blue
 Puntigam, Franz: 57, 175
 Pyš, E.: 194

 — Q —
 quantum efficiency: 165
 Queisner, R.: 216

 — R —
 Rademacher, Werner: 83,
 87, 94f., 101, 103, 126,
 129, 131f.
 Rahm, Director: 387
 Rajsko: 61
 Raleigh, NC: 11, 182
 Ranke, Leopold: 36
 Rasch, W.: 64
 Rassinier, Paul: 29, 295
 Ratzinger, Joseph Cardinal:
 429
 Ravensbrück: 223
 Ray, K.C.: 146
 Reich, Harald: 279
 Reitlinger, Gerald: 382
 Rembiszewski, Sarah: 431
 Remer Depesche: 379-381,
 400, 420f., 426
 Remer, Anneliese: 303, 309
 Remer, Otto Ernst: 230,
 279, 301-311, 357-385,
 389-391, 399f., 408-412,
 420-426
 Renk, Brian: 116
 Republikaner: 289-296, 301
 Resistance, French: 29, 295
 Reykjavik: 353
 Reynouard, Vincent: 224
 Ricketts, scientist: 54
 Rickettsia: 54
 Rieger, Jürgen: 280, 356
 Rijeka, Croatia: 15
 Röbert, S.: 169
 Robin, M.B.: 146
 Rocker, Stefan: 403f.
 Roding, Germany: 361, 362
 Rohwer, Jürgen: 30
 Rollet, Henry: 31
 Romania: 187
 Roques, Henri: 355
 Rosenberg, Walter: 194
 Rosenthal, Ludwig: 194
 Roßmann, E.: 21

- Roth, James: 231f., 259-261
 Roubeix, Gérard: 223f.
 Rückertl, Adalbert: 31, 44, 194
 Rudolf, Georg Hermann: 432
 Rudolf, Germar: 13, 20, 33f., 46f., 54, 58, 95, 97, 101, 104, 108, 117, 126, 129, 136, 141, 168, 185-189, 194, 205, 226f., 230, 232, 238-240, 257, 262, 266-278, Part II
 Rudolf, Ursula: 428
 Rummel, Werner: 180
 Rushton, Colin: 96
 Russia: 54f.
 campaign WWI: 54
 campaign WWII: 49
 government: 41
 Rüter, Christiaan F.: 44
- S —
- Sachsenhausen: 82
 San Quentin Prison: 12
 Sanford, George: 41
 Sanning, Walter N.: 31, 187
 Sarin: 226
 Sassmannshausen, Jörg: 422
 SAT 1 TV: 422
 sauna: 59f., 65, 69, 94, 129, 382
 Saxena, R.S.: 146
 Saxony: 292
 Scandola, F.: 147
 Schäfer, H.: 146, 159f., 164, 167
 Schaller, Herbert: 280, 306, 381, 383, 388-390
 Scheel, Dr.: 77, 370, 379
 Schittenhelm, A.: 54
 Schlee, Emil: 280
 Schlesiger, Wilhelm: 404, 422f., 428
 Schmidt, Robert F.: 181, 217
 Schoenberner, Gerhard: 194
 Scholz, Rainer: 362
 Schreiber, Walter: 83, 96
 Schultze, Karl (Topf): 90
 Schuster, Wolfgang: 32
 Schütz, Willibald: 145
 Schwaibold, Frank: 408-410
- Schwarz, L.: 175
 Schwarzenbach, D.: 145
 Schwefurt, Germany: 381, 420
 Schwertfeger, Reinhold: 372
 Searchlight: 415
 Sedlatschek: 430
 Seifer, G.B.: 161
 Seine-Maritime: 19
 Serbia: 285
 Shapiro, Shelly: 32
 Shapiro, Shelly: 26
 Sheftel, Yoram: 372
 shower heads: 90f., 219f.
 showers: 90-93, 205, 219f.
 Siebenbürger, judge: 376, 379, 382, 387
 Siemens: 102
 Silesia: 258, 287
 Simon, Arndt: 422
 Sistino, J.A.: 146, 159
 skin
 green/blue of gassing victims: 120, 180, 221
 lampshades made of human: 372
 poisoning through: 13f., 19, 179f., 203, 217, 221
 Sleipnir: 394, 427
 Slough, England: 166
 smoke
 from cremation pits: 128, 133, 189, 219, 275
 from crematorium chimney: 222
 smoking in 'gas chamber': 186
 soap
 from Jewish fat: 372
 in 'gas chamber': 205
 Sobibor: 227
 Sola river: 130
 Soldat im Volk: 378
 Solms, Armin: 394f., 400
 solubility product: 161
 Somani, Satu M.: 182
 Sonderbehandlung: 100, 431
 Sonderkommando: 92, 185-188, 193, 217-221, 275, 278
 Sorbonne: 30
- Soulié, Louis: 19
 Spain: 31, 303
 SPD: 293f.
 Special Treatment: 99f., 431
 Spotted Fever: 54
 St. Avold: 223
 Stäglich, Wilhelm: 30, 300, 315, 361
 Stalin, Joseph: 42, 373, 381
 Stalingrad: 87
 Stark, Hans: 194
 Stasicka, Z.: 147
 State Security Department, German: 399
 Stein, Burkhardt: 391
 Steinbach, Peter: 44
 Steinenbronnen, Germany: 400, 430
 stern magazine: 422
 Stern, Kenneth: 196
 Stingl, Josef: 429
 Stochel, G.: 147
 Stomper, Herbert: 429
 Strauß, Franz-Josef: 285f., 289, 391, 429
 Strauß, Marianne: 391
 Stromberger, Wilhelm: 55, 100
 Stuparek: 379
 Stuttgart: 30, 39, 168, 172, 230, 232, 243, 280, 311, 399, 401
 Süddeutscher Rundfunk: 406-410
 Sudeten: 286, 303
 Südwestfunk: 407, 410
 Sundance Film Festival: 13
 suspension: 146
 Süßmuth, Rita: 293
 Switzerland: 31
 synagogue: 403
- T —
- Tabeau, Jerzy: 194
 Tabun: 226
 Tada, H.: 165
 tageszeitung: 382
 Tananaev, I.V.: 161, 163
 Tarrassevich: 54
 tartrate: 164
 Tauber, Henryk: 104, 111, 184-189

- Taunusstein: 231, 239, 280, 399
 Tel Aviv: 310, 431
 Telegraph, Daily: 319
 Telegraph, Sunday: 317-325, 330, 337, 342, 350, 413, 415
 Teller: 169
 Tesch und Stabenow: 103
 Tesch, Bruno: 71, 197
 Teschner, Susanne: 392
 Thion, Serge: 29, 78
 Thomas Dehler Stiftung: 419
 thought criminal: 375
 Töben, Fredrick: 113, 280, 356
 Topf & Söhne: 90-93, 97, 100-103, 121
 Toronto: 23, 230, 259
 towels
 in 'gas chamber': 205
 Treblinka: 381, 386, 397
 Trombley, Stephen: 12f.
 Trzcinska, Beate: 33, 257
 Tübingen, Germany: 311, 364
 Tuisconia Königsberg, fraternity: 428f.
 Tunbridge Wells: 318, 320f.
 Turnbull's Blue: 19, 166, = Iron Blue
 typhus: 24, 49, 54f., 65, 68, 71, 100, 132f., 226, 228
 epidemic: 54
 louse-borne: 54
 — U —
 Uckfield: 316-320, 328f., 332f., 336
 Uglow, W.A.: 176
 Ullstein-Langen Müller: 304f.
 Undressing Room: 59f., 90
 University of Bonn: 285, 437
 University of Cologne: 307
 University of Lyon II: 23, 29
 University of Stuttgart: 281, 408, 424f., 437
 University of Tel Aviv: 431
 Untergriesbach, Bavaria: 20
 Upper District Court
 Düsseldorf: 381
 Munich: 363
 Upper Silesia: 47, 49, 166, 227, 229
 USSR: 40, 287, 382, 385
 — V —
 Vaillant-Couturier, Claude: 194, 218
 van Alstine, Mark: 119
 van Pelt, Robert J.: 34f., 45-47, 78, 85, 93, 97-101, 115-119, 211, 260, 265, 272, 350
 VARTA Batterie AG: 169, 280
 Vecernji List: 16
 VEDAG Vereinigte Dachpappen-Fabriken Aktiengesellschaft: 92f.
 ventilation: 97, 133f., 206-208, 218, 222, 279
 accident: 16
 crematorium I: 74-79, 186
 crematorium II/III: 85f., 90, 97-101, 199, 208-212, 218, 262, 275, 278
 crematorium IV/V: 124, 126, 217, 275, 278
 disinfestation: 58, 72, 102, 133, 212, 219
 farmhouses: 217, 275, 278
 homicidal chamber: 134, 196, 205, 212-214, 221f., 229
 short circuit: 208, 218
 U.S. execution chamber: 13
 Verbeke, Herbert: 395f.
 Verein Deutscher Studenten: 290
 Verein Deutscher Zementwerke: 171f.
 Verfassungsschutz: 352, 411
 Vergasungskeller: see Gaskeller
 Verlag der Freunde: 368
 Vidal Naquet, Pierre: 30
 Vienna: 45
 Vincennite: 19
 Vistula river: 130
 vol.‰: 143
 von Habsburg, Otto: 429
 von Hase & Köhler: 304f.
 von Schjerning, Otto: 54
 von Schnering, Hans Georg: 305, 421-424
 von Stahl, Alexander: 429
 von Weizsäcker, Richard: 380
 Vrba, Rudolf: 194
 Vrij Historisch Onderzoek: 414
 — W —
 Wahl, Max: 363
 Walendy, Udo: 32, 45, 71, 194, 197, 363
 Wannock: 317
 War Refugee Board: 194
 Watanabe, H.: 165
 Watt, G.D.: 147
 Waubke, N.V.: 170, 172
 Weast, R.C.: 143, 154, 161
 Weber, Dr.: 168
 Weber, Jürgen: 44
 Wegner, Werner: 32, 196, 198, 237, 279, 420
 Wehrer, C.: 164
 Weise, Gerhard: 226
 Weiss, Janda: 194
 Wellers, Georges: 33, 196, 198
 Wellhöner, Hans-Herbert: 180
 Werber, Martin: 56
 Wesche, K.: 169, 170
 Westphal, Hans Karl: 362
 Wetter, Friedrich Cardinal: 429
 Wetzler, Alfred: 194
 Wiberg, N.: 146
 Widmann, Richard: 48
 Wiesbaden, Germany: 399
 Wiesenfeld, Bavaria: 19f.
 Wikipedia: 267
 Wilde, R.E.: 146
 Wilson, C.: 162
 Wilson, Kenneth R.: 106
 windows, gas-tight: 125
 Winkler, H.: 159
 Winnacker: 164

- wire mesh push-in devices: — Y —
 see Yugoslavia: 287
- Drahtnetzzeinschiebevorrichtungen — Z —
- Wirth, Wolfgang: 180 Zacher, Hanns F.: 421, 422
- Wirths, Eduard: 64-66 Zaidi, S.A.: 165
- Wissmann, Matthias: 429 Zaun, A.: 71
- Witzsch, Hans-Jürgen: 168 ZDF, heute: 412
- Wohlrab, R.: 55 Zentralbauleitung der
 Wollfsohn, Michael: 391 Waffen SS und Polizei,
 Woodman, J.H.: 165 Auschwitz: 48, 66, 83, 87-
 Wright, E.A.: 228 93, 97, 99, 103
 Wüstinger, Emil: 57, 64, 98 Zentralrat der Juden in
 Wyman, David S.: 194 Deutschland: 280, 377,
 409, 421, 423
- Zentralsauna: 53, 92f., 126,
 130f., 135
- Zernik, Franz: 180
- Zhel'vis, E.F.: 146
- Zimmermann, Günter: 20
- Zitelmann, Rainer: 32, 280
- Zündel, Ernst: 23, 26, 230,
 259, 261, 300, 305
- Zwerenz, Winfried: 279,
 420
- Zyklon B: chapter 7.2., and
 passim.

Praise for the first edition of *The Rudolf Report*:

“I am extraordinarily impressed. To my knowledge, you are the first expert in Germany who has addressed this particular topic in a scholarly, impeccable and well-founded way. It is not for me to attribute an ice-breaker function to your expert report. It is easy to see which political-historical effects will originate from it, though its entire dimension cannot yet be estimated.” —Prof. Dr. Hellmut Diwald, Historian, January 22, 1992

“I read it with great interest. ... My impression is, however, that this expert report is an important contribution to a very important question which, since the ‘Leuchter Report,’ needs to be answered urgently. ... One can only very much hope that the well-known tactics of hushing up is not applied to your expert report, but that critical responses and comments will be made.” —Prof. Dr. Ernst Nolte, Historian, January 28, 1992

“For me, the significance of receiving your report rests on the fact that it substantially contributes to our stock of knowledge. With many of my colleagues active in the field of contemporary history, I am overjoyed and thankful for you having initiated this research activity. Of course, I am even more delighted regarding the results of your accurate scientific investigation.” —Prof. Dr. Werner Georg Haverbeck, Historian, January 31, 1992

“I calmly read your report. It gives me hope to realize that a representative of the younger generation courageously sets out, with scientific thoroughness, noticeable great expertise, and corresponding investigative curiosity, to get to the bottom of a controversial question that is of worldwide significance. The result is clear and unequivocal. True facts cannot be suppressed forever. I wish that your work will make the breakthrough.”—Prof. Emil Schlee, Historian, April 1, 1992

“I sincerely hope that all statements about this topic would obviously be based on long and intensive work such as yours. Most of it is certainly unverifiable for the layman, but the photographs are already quite informative.” —Prof. Dr. Ernst Nolte, Historian, January 6, 1993

“Germar Rudolf is a young scientist who tried to prove in an excellently layed-out work, with tables, graphics and so on, that the gas chambers were technically impossible. ... These scientific analyses are perfect.” —Hans Westra, Anne-Frank-Foundation, BRT 1 TV (Belgium), Panorama, April 27, 1995

“All in all, [Rudolf] relies on literature which was written long before this report was completed, and the report must be described as scientifically acceptable.” —Prof. Dr. Henri Ramuz, Chemist, interrogated as expert witness about *The Rudolf Report* by the Swiss Court at Châtel-St.-Denis, May 18, 1997

HOLOCAUST HANDBOOKS

This ambitious, growing series addresses various angles of the “Holocaust” of the WWII era. Most of them are based on decades of research from archives all over the world. They are heavily footnoted and referenced. In contrast to most other works on this issue, the tomes of this series approach its topic with profound academic scrutiny and a critical attitude. Any Holocaust researcher ignoring this series will remain oblivious to some of the most important research in the field. These books are designed to both convince the common reader as well as academics. The following books have appeared so far and are available from THE BARNES REVIEW and CODOH/CASTLE HILL PUBLISHERS:

SECTION ONE: General Overviews of the Holocaust

The First Holocaust. The Surprising Origin of the Six-Million Figure. By Don Heddesheimer. This compact but substantive study documents



propaganda spread prior to, during and after the FIRST World War that claimed East European Jewry was on the brink of annihilation. The magic number of suffering and dying Jews was 6 million back then as well. The book details how these Jewish fundraising operations in America raised vast sums in the name of feeding

suffering Polish and Russian Jews but actually funneled much of the money to Zionist and Communist groups. 3rd edition, 188 pages, b&w illustrations, bibliography, index. (#6)

Lectures on the Holocaust. Controversial Issues Cross Examined. By Germar Rudolf. Between 1992 and 2005 German scholar Germar

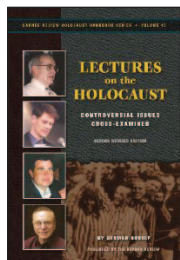

Rudolf lectured to various audiences about the Holocaust in the light of new findings. Rudolf’s sometimes astounding facts and arguments fell on fertile soil among his listeners, as they were presented in a very sensitive and scholarly way. This book is the literary version of Rudolf’s lectures, enriched with the most recent

findings of historiography. Rudolf introduces the most important arguments for his findings, and his audience reacts with supportive, skeptical and also hostile questions. We believe this book is the best introduction into this taboo topic. Second edition, 500 pages, b&w illustrations, bibliography, index. (#15)

Breaking the Spell. The Holocaust, Myth & Reality. By Nicholas Kollerstrom. In 1941, British Intelligence analysts cracked the German “Enigma” code. Hence, in 1942 and 1943, encrypted radio communications between German concentration camps and the Berlin headquarters were decrypted. The intercepted data refutes, the orthodox “Holocaust” narrative. It



Pictured above are all of the scientific studies that comprise the series *Holocaust Handbooks* published thus far. More volumes and new editions are constantly in the works.

reveals that the Germans were desperate to reduce the death rate in their labor camps, which was caused by catastrophic typhus epidemics. Dr. Kollerstrom, a science historian, has taken these intercepts and a wide array of mostly unchallenged corroborating evidence to show that “witness statements” supporting the human gas chamber narrative clearly clash with the available scientific data. Kollerstrom concludes that the history of the Nazi “Holocaust” has been written by the victors with ulterior motives. It is distorted, exaggerated and largely wrong. With a foreword by Prof. Dr. James Fetzer. 2nd edition, 257 pages, b&w illustrations, bibliography, index. (#31)

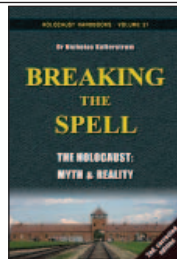

Debating the Holocaust. A New Look at Both Sides. By Thomas Dalton. Mainstream historians insist that there cannot be, may not be a debate about the Holocaust. But ignoring it does not make this controversy go away. Traditional scholars admit that there was neither a budget, a plan, nor an order for the Holocaust; that the key camps have all but vanished, and so have any human remains; that material and unequivocal documentary evidence is absent; and that there are serious problems with survivor testimonies. Dalton juxtaposes the traditional

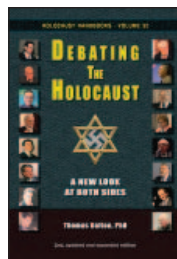

All books are 6”x9” paperbacks unless otherwise stated. Library discounts are available for the whole set and all subsequent volumes.

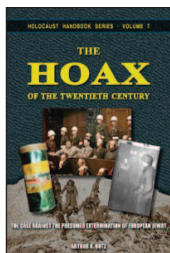

Holocaust narrative with revisionist challenges and then analyzes the mainstream's responses to them. He reveals the weaknesses of both sides, while declaring revisionism the winner of the current state of the debate. 2nd, revised and expanded edition, 332 pages, b&w illustrations, bibliography, index. (#32)

The Hoax of the Twentieth Century. The Case against the Presumed Extermination of European Jewry. By Arthur R. Butz. The first writer to analyze the entire Holocaust complex in a precise scientific manner. This book exhibits the overwhelming force of arguments accumulated by the mid-1970s. It continues to be a major historical reference work, frequently cited by prominent personalities. This edition has numerous supplements with new information gathered over the last 35 years. Fourth edition, 524 pages, b&w illustrations, bibliography, index. (#7)

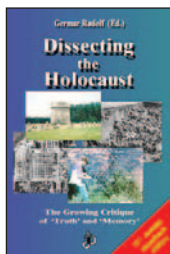

Dissecting the Holocaust. The Growing Critique of 'Truth' and 'Memory.' Edited by Germer Rudolf. *Dissecting the Holocaust* applies state-of-the-art scientific technique and classic methods of detection to investigate the alleged murder of millions of Jews by Germans during World War II. In 22 contributions—each of some 30 pages—the 17 authors dissect generally accepted paradigms of the “Holocaust.” It reads as exciting as a crime novel: so many lies, forgeries and deceptions by politicians, historians and scientists are proven. This is the intellectual adventure of the 21st century. Be part of it! Second revised edition. 616 pages, b&w illustrations, bibliography, index. (#1)



The Dissolution of Eastern European Jewry. By Walter N. Sanning. Six Million Jews died in the Holocaust. Sanning did not take that number at face value, but thoroughly explored European population developments and shifts mainly caused by emigration as well as deportations and evacuations conducted by both Nazis and the Soviets, among other things. The book is based mainly on Jewish, Zionist and mainstream sources. It concludes that a sizeable share of the Jews found missing during local censuses after the Second World War, which were so far counted as “Holocaust victims,” had either emigrated (mainly to Israel or the U.S.) or had been deported by Stalin to Siberian labor camps. 2nd, corrected edition, foreword by A.R. Butz, epilogue by Germer Rudolf containing important updates; ca. 220 pages, b&w illustrations, bibliography (#29).

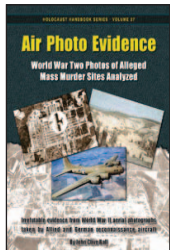

Air Photo Evidence: World War Two Photos of Alleged Mass Murder Sites Analyzed. By John C. Ball. During World War Two both German and Allied reconnaissance aircraft took countless air photos of places of tactical and strategic interest in Europe. These photos are prime evidence for the investigation of the Holocaust. Air photos of locations like Auschwitz, Majdanek, Treblinka, Babi Yar etc. permit an insight into what did or did not happen there. John Ball has unearthed many pertinent photos and has thoroughly analyzed them. This book is full of air photo reproductions and schematic drawings explaining them. According to the author, these images refute many of the atrocity claims made by witnesses in connection with events in the German sphere of influence. 3rd revised and expanded edition. Edited by Germer Rudolf; with a contribution by Carlo Mattogno. 168 pages, 8.5”x11”, b&w illustrations, bibliography, index (#27).

The Leuchter Reports: Critical Edition. By Fred Leuchter, Robert Faurisson and Germer Rudolf. Between 1988 and 1991, U.S. expert on execution technologies Fred Leuchter wrote four detailed reports addressing whether the Third Reich operated homicidal gas chambers. The first report on Auschwitz and Majdanek became world famous. Based on chemical analyses and various technical arguments, Leuchter concluded that the locations investigated “could not have then been, or now be, utilized or seriously considered to function as execution gas chambers.” 4th edition, 252 pages, b&w illustrations. (#16)

The Giant with Feet of Clay: Raul Hilberg and His Standard Work on the "Holocaust." By Jürgen Graf. Raul Hilberg's major work *The Destruction of European Jewry* is an orthodox standard work on the Holocaust. But what evidence does Hilberg provide to back his thesis that there was a German plan to exterminate Jews, carried out mainly in gas chambers? Jürgen Graf applies the methods of critical analysis to Hilberg's evidence and examines the results in light of modern historiography. The results of Graf's critical analysis are devastating for Hilberg. 2nd, corrected edition, 139 pages, b&w illustrations, bibliography, index. (#3)

Jewish Emigration from the Third Reich. By Ingrid Weckert. Current historical writings about the Third Reich claim state it was difficult for Jews to flee from Nazi persecution. The truth is that Jewish emigration was welcomed by the German authorities. Emigra-



tion was not some kind of wild flight, but rather a lawfully determined and regulated matter. Weckert's booklet elucidates the emigration process in law and policy. She shows that German and Jewish authorities worked closely together. Jews interested in emigrating received detailed advice and offers of help from both sides. 72 pages, index. (#12) (cover shows new reprint edition in preparation)

Inside the Gas Chambers: The Extermination of Mainstream Holocaust Historiography. By Carlo Mattogno. Neither increased media propaganda or political pressure nor judicial persecution can stifle revisionism. Hence, in early 2011, the Holocaust Orthodoxy published a 400 pp. book (in German) claiming to refute "revisionist propaganda," trying again to prove "once and for all" that there were homicidal gas chambers at the camps of Dachau, Natzweiler, Sachsenhausen, Mauthausen, Ravensbrück, Neuengamme, Stutthof... you name them. Mattogno shows with his detailed analysis of this work of propaganda that mainstream Holocaust hagiography is beating around the bush rather than addressing revisionist research results. He exposes their myths, distortions and lies. 268 pages, b&w illustrations, bibliography. (#25)

SECTION TWO: Books on Specific Camps

Treblinka: Extermination Camp or Transit Camp? By Carlo Mattogno and Jürgen Graf. It is alleged that at Treblinka in East Poland between 700,000 and 3,000,000 persons were murdered in 1942 and 1943. The weapons used were said to have been stationary and/or mobile gas chambers, fast-acting or slow-acting poison gas, unslaked lime, superheated steam, electricity, diesel exhaust fumes etc. Holocaust historians alleged that bodies were piled as high as multi-storied buildings and burned without a trace, using little or no fuel at all. Graf and Mattogno have now analyzed the origins, logic and technical feasibility of the official version of Treblinka. On the basis of numerous documents they reveal Treblinka's true identity as a mere transit camp. 365 pages, b&w illustrations, bibliography, index. (#8)

Belzec in Propaganda, Testimonies, Archeological Research and History. By Carlo Mattogno. Witnesses report that between 600,000 and 3 million Jews were murdered in the Belzec camp, located in Poland. Various murder weapons are claimed to have

been used: diesel gas; unslaked lime in trains; high voltage; vacuum chambers; etc. The corpses were incinerated on huge pyres without leaving a trace. For those who know the stories about Treblinka this sounds familiar. Thus the author has restricted this study to the aspects which are new compared to Treblinka. In contrast to Treblinka, forensic drillings and excavations were performed at Belzec, the results of which are critically reviewed. 138 pages, b&w illustrations, bibliography, index. (#9)

Sobibor: Holocaust Propaganda and Reality. By Jürgen Graf, Thomas Kues and Carlo Mattogno. Between 25,000 and 2 million Jews are said to have been killed in gas chambers in the Sobibór camp in Poland. The corpses were allegedly buried in mass graves and later incinerated on pyres. This book investigates these claims and shows that they are based on the selective use of contradictory eyewitness testimony. Archeological surveys of the camp in 2000-2001 are analyzed, with fatal results for the extermination camp hypothesis. The book also documents the general National Socialist policy toward Jews, which never included a genocidal "final solution." 434 pages, b&w illustrations, bibliography, index. (#19)

The "Extermination Camps" of "Aktion Reinhardt". By Jürgen Graf, Thomas Kues and Carlo Mattogno. In late 2011, several members of the exterminationist *Holocaust Controversies* blog published a study which claims to refute three of our authors' monographs on the camps Belzec, Sobibor and Treblinka (see previous three entries). This tome is their point-by-point response, which makes "mince-meat" out of the bloggers' attempt at refutation. It requires familiarity with the above-mentioned books and constitutes a comprehensive update and expansion of their themes. 2nd edition, two volumes, total of 1396 pages, illustrations, bibliography. (#28)

Chelmo: A Camp in History & Propaganda. By Carlo Mattogno. The world's premier holocaust scholar focuses his microscope on the death camp located in Poland. It was at Chelmo that huge masses of prisoners—as many as 1.3 million—were allegedly rounded up and killed. His book challenges the conventional wisdom of what went on inside Chelmo. Eyewitness statements, forensics reports, corners' reports, excavations, crematoria, building plans, U.S. reports, German documents, evacuation efforts, mobile gas vans for homicidal purposes—all

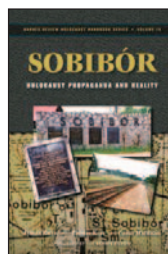
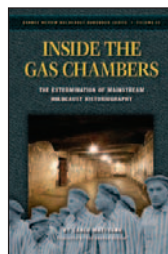

are discussed, 191 pages, indexed, illustrated, bibliography. (#23)

The Gas Vans: A Critical Investigation. (A perfect companion to the Chelmno book.) By Santiago Alvarez and Pierre Marais. It is alleged that the Nazis used mobile gas chambers to exterminate 700,000 people. Up until 2011, no thorough monograph had appeared on the topic. Santiago Alvarez has remedied the situation. Are witness statements reliable? Are documents genuine? Where are the murder weapons? Could they have operated as claimed? Where are the corpses? Alvarez has scrutinized all known wartime documents, photos and witness statements on this topic, and has examined the claims made by the mainstream. 390 pages, b&w illustrations, bibliography, index. (#26)

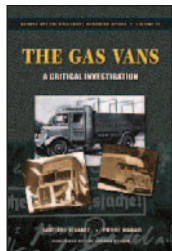

Concentration Camp Majdanek. A Historical and Technical Study. By Carlo Mattogno and Jürgen Graf. Little research had been directed toward Concentration Camp Majdanek in central Poland, even though it is claimed that up to a million Jews were murdered there. The only information available is discredited Polish Communist propaganda. This glaring research gap has finally been filled. After exhaustive research of primary sources, Mattogno and Graf created a monumental study which expertly dissects and repudiates the myth of homicidal gas chambers at Majdanek. They also critically investigated the legend of mass executions of Jews in tank trenches (“Operation Harvest Festival”) and prove them groundless. The authors’ investigations lead to unambiguous conclusions about the camp which are radically different from the official theses. Again they have produced a standard and methodical investigative work, which authentic historiography cannot ignore. Third edition, 350 pages, b&w illustrations, bibliography, index. (#5)

Concentration Camp Stutthof and Its Function in National Socialist Jewish Policy. By Carlo Mattogno and Jürgen Graf. The Stutthof camp in Prussia has never before been scientifically investigated by traditional historians, who claim nonetheless that Stutthof served as a ‘makeshift’ extermination camp in 1944. Based mainly on archival resources, this study thoroughly debunks this view and shows that

Stutthof was in fact a center for the organization of German forced labor toward the end of World War II. Third edition, 171 pages, b&w illustrations, bibliography, index. (#4)

SECTION THREE: Auschwitz Studies

The Real Case of Auschwitz: Robert van Pelt’s Evidence from the Irving Trial Critically Reviewed. By Carlo Mattogno. Prof. Robert van Pelt is considered one of the best mainstream experts on Auschwitz and has been called upon several times in holocaust court cases. His work is cited by many to prove the holocaust happened as mainstream scholars insist. This book is a scholarly response to Prof. van Pelt—and Jean-Claude Pressac. It shows that their studies are heavily flawed. This is a book of prime political and scholarly importance to those looking for the truth about Auschwitz. 2nd edition, 758 pages, b&w illustrations, glossary, bibliography, index. (#22)

Auschwitz: Plain Facts—A Response to Jean-Claude Pressac. Edited by Germar Rudolf. French pharmacist Jean-Claude Pressac tried to refute recent findings with their own technical methods. For this he was praised by the mainstream, and they proclaimed victory over the “revisionists.” In *Auschwitz: Plain Facts*, Pressac’s works and claims are debunked. 197 pages, b&w illustrations, bibliography, index. (#14)

The Rudolf Report. Expert Report on Chemical and Technical Aspects of the ‘Gas Chambers’ of Auschwitz. By Germar Rudolf and Dr. Wolfgang Lambrecht. In 1988, execution expert Fred Leuchter investigated the gas chambers of Auschwitz and Majdanek and concluded that they could not have worked as claimed. Ever since, Leuchter’s work has been attacked. In 1993, Germar Rudolf published a thorough forensic study about the “gas chambers” of Auschwitz. His report irons out the deficiencies of “The Leuchter Report.” Second edition, 457 pages, b&w illustrations, bibliography, index. (#2)

Auschwitz Lies: Legends, Lies and Prejudices on the Holocaust. By Carlo Mattogno and Germar Rudolf. The fallacious research and alleged “refutation” of Revisionist scholars by French biochemist G. Wellers, Polish Prof. J. Markiewicz, chemist Dr. Richard Green, Profs. Zimmerman, M. Shermer and A. Grobman, as well as researchers Keren, McCarthy and

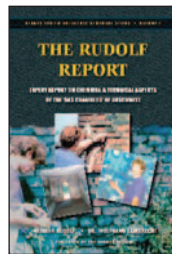
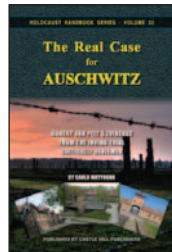
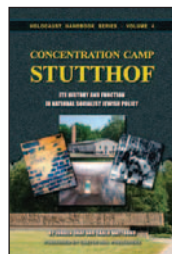
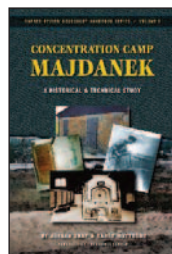
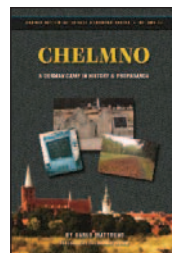

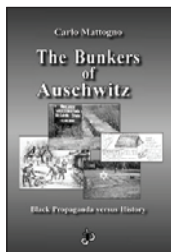
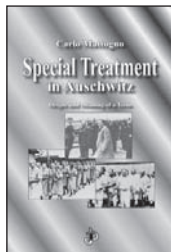
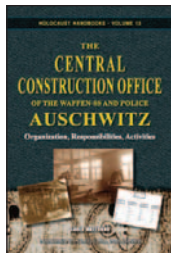

Mazal, are exposed for what they are: blatant and easily exposed political lies created to ostracize dissident historians. In this book, facts beat propaganda once again. Second edition, 398 pages, b&w illustrations, index. (#18)

Auschwitz: The Central Construction Office. By Carlo Mattogno. Based upon mostly unpublished German wartime documents, this study describes the history, organization, tasks and procedures of the Central Construction Office of the Waffen-SS and Auschwitz Police. Despite a huge public interest in the camp, next to nothing was really known about this office, which was responsible for the planning and construction of the Auschwitz camp complex, including the crematories which are said to have contained the “gas chambers.” 2nd ed., 188 pages, b&w illustrations, glossary, index. (#13)

Garrison and Headquarters Orders of the Auschwitz Camp. By C. Mattogno. A large number of all the orders ever issued by the various commanders of the infamous Auschwitz camp have been preserved. They reveal the true nature of the camp with all its daily events. There is not a trace in these orders pointing at anything sinister going on in this camp. Quite to the contrary, many orders are in clear and insurmountable contradiction to claims that prisoners were mass murdered. This is a selection of the most pertinent of these orders together with comments putting them into their proper historical context. (Scheduled for early 2016; #34)

Special Treatment in Auschwitz: Origin and Meaning of a Term. By Carlo Mattogno. When appearing in German wartime documents, terms like “special treatment,” “special action,” and others have been interpreted as code words for mass murder. But that is not always true. This study focuses on documents about Auschwitz, showing that, while “special” had many different meanings, not a single one meant “execution.” Hence the practice of deciphering an alleged “code language” by assigning homicidal meaning to harmless documents – a key component of mainstream historiography – is untenable. 151 pages, b&w illustrations, bibliography, index. (#10)

Health Care at Auschwitz. By Carlo Mattogno. In extension of the above study on *Special Treatment in Auschwitz*, this study proves the extent to which the German authorities at Auschwitz tried to provide appropriate health care for the inmates. This is frequently described as special mea-

asures to improve the inmates’ health and thus ability to work in Germany’s armaments industry. This, after all, was the only thing the Auschwitz authorities were really interested in due to orders from the highest levels of the German government. (Scheduled for early 2016; #33)

The Bunkers of Auschwitz: Black Propaganda vs. History. By Carlo Mattogno. The bunkers at Auschwitz are claimed to have been the first homicidal gas chambers at Auschwitz specifically equipped for this purpose. With the help of original German wartime files as well as revealing air photos taken by Allied reconnaissance aircraft in 1944, this study shows that these homicidal “bunkers” never existed, how the rumors about them evolved as black propaganda created by resistance groups in the camp, and how this propaganda was transformed into a false reality. 264 pages, illustrations, bibliography, index. (#11)

Auschwitz: The First Gassing—Rumor and Reality. By Carlo Mattogno. The first gassing in Auschwitz is claimed to have occurred on Sept. 3, 1941, in a basement room. The accounts reporting it are the archetypes for all later gassing accounts. This study analyzes all available sources about this alleged event. It shows that these sources contradict each other in location, date, preparations, victims etc, rendering it impossible to extract a consistent story. Original wartime documents inflict a final blow to this legend and prove without a shadow of a doubt that this legendary event never happened. Second edition, 168 pages, b&w illust., bibliography, index. (#20)

Auschwitz: Crematorium I and the Alleged Homicidal Gassings. By Carlo Mattogno. The morgue of Crematorium I in Auschwitz is said to be the first homicidal gas chamber there. This study investigates all statements by witnesses and analyzes hundreds of wartime documents to accurately write a history of that building. Mattogno proves that its morgue was never a homicidal gas chamber, nor could it have worked as such. 138 pages, b&w illustrations, bibliography, index. (#21)

Auschwitz: Open Air Incinerations. By Carlo Mattogno. Hundreds of thousands of corpses of murder victims are claimed to have been incinerated in deep ditches in the Auschwitz concentration camp. This book examines the many testimonies regarding these incinerations and establishes whether

these claims were even possible. Using aerial photographs, physical evidence and wartime documents, the author shows that these claims are fiction. A must read. 132 pages, b&w illustrations, bibliography, index. (#17)

The Cremation Furnaces of Auschwitz. By Carlo Mattogno & Franco Deana. An exhaustive technical study of the history and technology of cremation in general and of the cremation furnaces of Auschwitz in particular. On a sound and thoroughly documented base of technical literature, extant wartime documents and material traces, Mattogno and Deana can establish the true nature and capacity of the Auschwitz cremation furnaces. They show that these devices were cheaper versions than what was usually produced, and that their capacity to cremate corpses was lower than normal, too. Hence this study reveals that the Auschwitz cremation furnaces were not monstrous super ovens but rather inferior make-shift devices. 3 vols., 1198 pages, b&w and color illustrations (vols 2 & 3), bibliography, index, glossary. (#24)

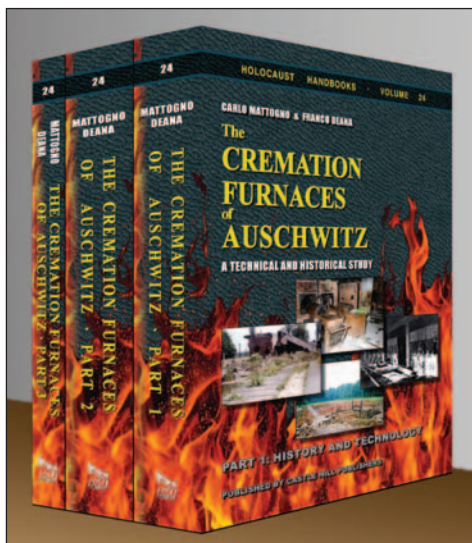

SECTION FOUR Witness Critique

Holocaust High Priest: Elie Wiesel, Night, the Memory Cult, and the Rise of Revisionism. By Warren B. Routledge. The first unauthorized biography of Wiesel exposes both his personal deceptions and the whole myth of “the six million.” It shows how Zion-

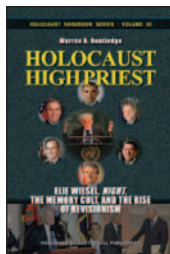

ist control has allowed Wiesel and his fellow extremists to force leaders of many nations, the U.N. and even popes to genuflect before Wiesel as symbolic acts of subordination to World Jewry, while at the same time forcing school children to submit to Holocaust brainwashing. 468 pages, b&w illust., bibliography, index. (#30)

Auschwitz: Confessions and Testimonies. By Jürgen Graf. The traditional narrative of what transpired at the infamous Auschwitz camp during WWII rests almost exclusively on witness testimony from former inmates as well as erstwhile camp officials. This study critically scrutinizes the 40 most important of these witness statements by checking them for internal coherence, and by comparing them with one another as well as with other evidence such as wartime documents, air photos, forensic research results, and material traces. The result is devastating for the traditional narrative. (Scheduled for summer 2016; #36)

Commandant of Auschwitz: Rudolf Höss, His Torture and His Forced Confessions. By Rudolf Höss & Carlo Mattogno. When Rudolf Höss was in charge at Auschwitz, the mass extermination of Jews in gas chambers is said to have been launched and carried out. He confessed this in numerous postwar depositions. Hence Höss’s testimony is the most convincing of all. But what traditional sources usually do not reveal is that Höss was severely tortured to coerce him to “confess,” and that his various statements are not only contradictory but also full of historically and physically impossible, even absurd claims. This study expertly analyzes Höss’s various confessions and lays them all open for everyone to see the ugly truth. (Scheduled for summer 2016; #35)

An Auschwitz Doctor’s Eyewitness Account: The Tall Tales of Dr. Mengele’s Assistant Analyzed. By Miklos Nyiszli & Carlo Mattogno. Nyiszli, a Hungarian Jew who studied medicine in Germany before the war, ended up at Auschwitz in 1944 as Dr. Mengele’s assistant. After the war he wrote an account of what he claimed to have experienced. To this day some traditional historians take his accounts seriously, while others accept that it is a grotesque collection of lies and exaggerations. This study analyzes Nyiszli’s novel and skillfully separates truth from fabulous fabrication. (Scheduled for spring 2016; #37)

Further Projects

Further studies we propose to publish would scrutinize eyewitness accounts from, e.g., Filip Müller, Rudolf Vrba, Henryk Tauber, Yankiel Wiernik, Richard Glazar. Scholars interested in taking on any of these or other witnesses, please get in touch using the contact form at www.codoh.com/contact-us

For current prices and availability see outlets like Amazon.com or Amazon.co.uk, and:

Distribution USA: THE BARNES REVIEW, P.O. Box 15877, Washington, D.C., 20003; 1-877-773-9077; www.Barnes-Review.org

Distribution UK: CASTLE HILL PUBLISHERS, PO Box 243, Uckfield, TN22 9AW; shop.codoh.com

BOOKS BY AND FROM CASTLE HILL PUBLISHERS

Below please find some of the books published or distributed by Castle Hill Publishers in the United Kingdom. For our current and complete range of products visit our web store at shop.codoh.com.

Wilhelm Stäglich, *Auschwitz: A Judge Looks at the Evidence*

Auschwitz is the epicenter of the Holocaust, where more people are said to have been murdered than anywhere else. At this detention camp the industrialized Nazi mass murder is said to have reached its demonic pinnacle. This narrative is based on a wide range of evidence, the most important of which was presented during two trials: the International Military Tribunal of 1945/46, and the German Auschwitz Trial of 1963-1965 in Frankfurt.

The late Wilhelm Stäglich, until the mid-1970s a German judge, has so far been the only legal expert to critically analyze this evidence. His research reveals the incredibly scandalous way in which the Allied victors and later the German judicial authorities bent and broke the law in order to come to politically foregone conclusions. Stäglich also exposes the shockingly superficial way in which historians are dealing with the many incongruities and discrepancies of the historical record. Second, corrected and slightly revised edition with a new preface and epilogue.

422 pp., 6"×9", pb, ill.

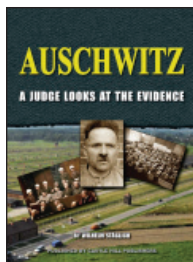

P. Angel, J. Tiffany: *Fountain of Fairytales: A Scholarly Romp Through the Old Testament*

Some say the Old Testament is a collection of valuable parables with no basis in historical fact, while others have made a living of trying to prove that it is an accurate history of early man. *Fountain of Fairytales* takes us on a whirlwind tour of the Old Testament, telling us which stories are pure balderdash and which may have some basis in real archeology and authentic history. And also which tales seem to have been borrowed from other primary cultural sources including the Egyptians. If you want proof the entire Bible is a faithful transcription of the word of God – straight from mouth to Jewish scribe's pen – read no further, for this book is more of a light-hearted yet scholarly tour of the Old Testament, not a dense religio-historical treatise. If you're ready for a tour of the Old Testament like none other, get a copy of *Fountain of Fairytales*.

178 pp. pb, 5.5"×8.5"

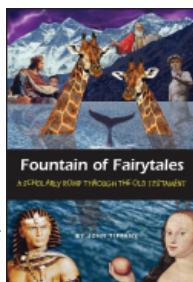

Abdallah Melaouhi, *Rudolf Hess. His Betrayal and Murder*

In May 1941, Rudolf Hess, Hitler's right-hand man, flew to England to make peace. His plane crashed, and he was made a prisoner of the Allies and kept in solitary confinement nearly the rest of his life. What truths about the war did Hess possess that were of such danger? The author worked as a male nurse caring for Rudolf Hess from 1982 until his death in 1987 at the Allied Prison in Berlin. Minutes after the murder he was called to the prison. Ask by the author what had happened, an unknown U.S. soldier replied: "The pig is finished; you won't have to work a night shift any longer." What he experienced there, minutely described in this book, proves beyond doubt that Mr. Hess was strangled to death by his Anglo-Saxon captors. 300 pp. pb, 6"×9", ill.

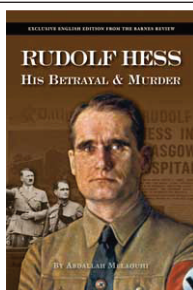

Curtis B. Dall, *FDR: My Exploited Father-in-Law*

The author was FDR's son-in-law and spent much time in the White House. He had an insider's view of who came to see FDR and Eleanor and how often. Dall also was a Wall Street banker and knew the tricks and tactics the financial predators use to deceive the public. The book is loaded with personal anecdotes of the people Dall met during his life. This included such notables as Franklin and Eleanor Roosevelt, Bernard Baruch, Henry Morgenthau Jr., Harry Dexter White, the Warburgs, Rothschilds, and more. Dall views the stock market crash of October 1929 as "the calculated shearing of the public triggered by the sudden shortage of call money in the New York money market." He views the Federal Reserve and their globalist cheerleaders as being against the interests of Americans. They plan and execute the wars that line their pockets and ravage the world. Dall portrays FDR as a man who began his career as an optimistic ladder-climber and ended up as one of the most manipulated presidents in U.S. history. Reprint with a foreword by Willis A. Carto.

298 pp., 5.5"×8.5", pb

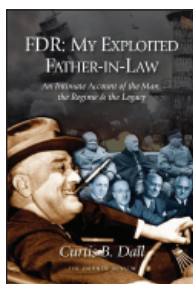

Herbert L. Brown, *The Devil's Handiwork. A Victim's View of "Allied" War Crimes*

An amazing compilation of war crimes committed by the "good guys" against the "bad guys." Many of the events covered in this book are to this day censored or twisted in mainstream history books. Chapters cover: Death camps in the Civil War; concentration camps in the Boer War; The Dresden Massacre – the worst war crime in history; the Ukrainian terror famine; the gruesome harvest in Eastern Europe; the myth of the 6 million; Operation Keelhaul; the Nuremberg Trials; the Katyn Forest Massacre; the Stuttgart Atrocity; bastardizing the Germans after WWII; the use of the atom bomb; Cuba betrayed; the Invasion of Lebanon; the policy of de-Nazification; the Malmedy Trial; the Dachau Trial; the Vinnytsia genocide; crimes during the occupation of Germany; FDR's Great Sedition Trial; the Morgenthau Plan; the propaganda of the Writers War Board; myths of civilian bombings; the Lend-Lease fiasco; truth about Auschwitz; Pearl Harbor; the Soviet genocide across Europe; much more.

275 pp., 5.5"×8.5", pb

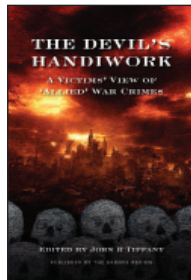

Ralph Grandinetti, *Final Solution. Germany's Madagascar Resettlement Plan*

Everyone "knows" the Germans had a "final solution" for their so-called "Jewish Problem." But Adolf Hitler's final solution did not involve homicidal gas chambers and blazing crematory ovens. Instead, Hitler's final solution offered Jewish leaders the island of Madagascar, back then a French colony. In a meeting with Vichy French Prime Minister Pierre Laval, Laval agreed to turn Madagascar into a new Jewish homeland where, ultimately, all of Europe's 4,000,000 Jews might be settled. This new Madagascar was to be governed by a joint German-French board with representation granted to any government cooperating. What a paradise Madagascar could have become, but instead Zionists insisted on occupying the "Holy Land," where they knew strife and conflict awaited them. What was the Madagascar Plan, and why did it fail? Which world leaders supported it – and which did not? Why was the plan eventually abandoned?

108 pp., 5.5"×8.5", pb



John Tiffany, *A Short History of the Balfour Declaration*

Few have heard of the Balfour Declaration, the history of which is known primarily to students of global affairs. What general knowledge there is surrounding its origins is usually limited to dry accounts in diplomatic histories. But here is a case where truth is stranger than fiction. The issuance of the Balfour Declaration set the stage for American entry into World War I and thereby laid the groundwork for World War II and the many consequential global convulsions that followed. And, ultimately, of course, it's the foundation of the tension in the Middle East today that points toward further war and destruction. Here is the secret history of the Balfour Declaration, laid out in no uncertain terms and devoid of euphemism and political correctness. Those who have any serious desire to understand the sources of world conflict need this precise and candid analysis – the facts – about the behind-the-scenes machinations that brought the Balfour Declaration into being – and why.

118 pp., 5.5"×8.5", pb

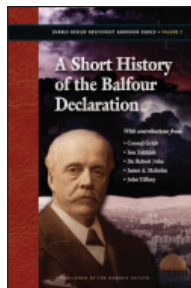

Germar Rudolf: *Resistance is Obligatory!*

In 2005 Rudolf, a peaceful dissident and publisher of revisionist literature, was kidnapped by the U.S. government and deported to Germany. There the local lackey regime staged a show trial against him for his historical writings. Rudolf was not permitted to defend his historical opinions, as the German penal law prohibits this. Yet he defended himself anyway: 7 days long Rudolf held a speech in the court room, during which he proved systematically that only the revisionists are scholarly in their attitude, whereas the Holocaust orthodoxy is merely pseudo-scientific. He then explained in detail why it is everyone's obligation to resist, without violence, a government which throws peaceful dissident into dungeons. When Rudolf tried to publish his public defence speech as a book from his prison cell, the public prosecutor initiated a new criminal investigation against him. After his probation time ended in 2011, he dared publish this speech anyway...

376 pp., 6"×9", pb, colour ill.

